

Agilent X-Series Signal Analyzer

**This manual provides documentation for the
for the following analyzers:**

MXA Signal Analyzer N9020A

EXA Signal Analyzer N9010A

N9068A Phase Noise Measurement Application User's and Programmer's Reference



Agilent Technologies

Notices

© Agilent Technologies, Inc. 2008, 2009

No part of this manual may be reproduced in any form or by any means (including electronic storage and retrieval or translation into a foreign language) without prior agreement and written consent from Agilent Technologies, Inc. as governed by United States and international copyright laws.

Trademark Acknowledgements

Microsoft “ is a U.S. registered trademark of Microsoft Corporation.

Windows “ and MS Windows “ are U.S. registered trademarks of Microsoft Corporation.

Adobe Reader “ is a U.S. registered trademark of Adobe System Incorporated.

Java™ is a U.S. trademark of Sun Microsystems, Inc.

MATLAB “ is a U.S. registered trademark of Math Works, Inc.

Norton Ghost™ is a U.S. trademark of Symantec Corporation.

Manual Part Number

N9068-90009
Supersedes:N9068-90008

Print Date

February 2009
Printed in USA

Agilent Technologies, Inc.
1400 Fountaingrove Parkway
Santa Rosa, CA 95403

Warranty

The material contained in this document is provided “as is,” and is subject to being changed, without notice, in future editions. Further, to the maximum extent permitted by applicable law, Agilent disclaims all warranties, either express or implied, with regard to this manual and any information contained herein, including but not limited to the implied warranties of merchantability and fitness for a particular purpose. Agilent shall not be liable for errors or for incidental or consequential damages in connection with the furnishing, use, or performance of this document or of any information contained herein. Should Agilent and the user have a separate written agreement with warranty terms covering the material in this document that conflict with these terms, the warranty terms in the separate agreement shall control.

Technology Licenses

The hardware and/or software described in this document are furnished under a license and may be used or copied only in accordance with the terms of such license.

Restricted Rights Legend

If software is for use in the performance of a U.S. Government prime contract or subcontract, Software is delivered and licensed as “Commercial computer soft-

ware” as defined in DFAR 252.227-7014 (June 1995), or as a “commercial item” as defined in FAR 2.101(a) or as “Restricted computer software” as defined in FAR 52.227-19 (June 1987) or any equivalent agency regulation or contract clause. Use, duplication or disclosure of Software is subject to Agilent Technologies’ standard commercial license terms, and non-DOD Departments and Agencies of the U.S. Government will receive no greater than Restricted Rights as defined in FAR 52.227-19(c)(1-2) (June 1987). U.S. Government users will receive no greater than Limited Rights as defined in FAR 52.227-14 (June 1987) or DFAR 252.227-7015 (b)(2) (November 1995), as applicable in any technical data.

Safety Notices

CAUTION

A CAUTION notice denotes a hazard. It calls attention to an operating procedure, practice, or the like that, if not correctly performed or adhered to, could result in damage to the product or loss of important data. Do not proceed beyond a CAUTION notice until the indicated conditions are fully understood and met.

WARNING

A WARNING notice denotes a hazard. It calls attention to an operating procedure, practice, or the like that, if not correctly performed or adhered to, could result in personal injury or death. Do not proceed beyond a WARNING notice until the indicated conditions are fully understood and met.

Warranty

This Agilent technologies instrument product is warranted against defects in material and workmanship for a period of one year from the date of shipment. During the warranty period, Agilent Technologies will, at its option, either repair or replace products that prove to be defective.

For warranty service or repair, this product must be returned to a service facility designated by Agilent Technologies. Buyer shall prepay shipping charges to Agilent Technologies and Agilent Technologies shall pay shipping charges to return the product to Buyer. However, Buyer shall pay all shipping charges, duties, and taxes for products returned to Agilent Technologies from another country.

Where to Find the Latest Information

Documentation is updated periodically. For the latest information about this analyzer, including firmware upgrades, application information, and product information, see the following URLs:

<http://www.agilent.com/find/mxa>

<http://www.agilent.com/find/exa>

To receive the latest updates by email, subscribe to Agilent Email Updates:

<http://www.agilent.com/find/emailupdates>

Information on preventing analyzer damage can be found at:

<http://www.agilent.com/find/tips>

1. Using Help

Locating Other Help Resources	52
Viewing Help on a separate Computer	53
Copying the HTML Help (CHM) Files	53
Copying the Acrobat (PDF) Files	54
How Help is Organized.	56
Help Contents Listing	56
System Functions	56
Key Descriptions for Each Measurement	57
Key Information for Softkeys	57
Common Measurement Functions	58
Front Panel Keys used by the Help System	59
Navigating Windows HTML Help (CHM) Files	60
HTML Help Window Components.	60
Basic Help Window Operations	61
Navigating the Help Window	62
Navigating Acrobat (PDF) Files	68
Adobe Reader Window	68
Printing Acrobat Files	69
Terms Used in This Documentation	71
Terms used in Key Parameter Tables	71
Context Sensitive Help not Available.	73
Finding a Topic without a Mouse and Keyboard	73
Selecting a Hyperlink without a Mouse	74

2. About the Analyzer

Installing Application Software	76
Viewing a License Key	76
Obtaining and Installing a License Key	76
Missing and Old Measurement Application Software	77
X-Series Options and Accessories	77
Front-Panel Features	80
Overview of key types.	83
Display Annotations	84
Rear-Panel Features	86
Window Control Keys	88
Multi-Window	88
Zoom	88
Next Window	89
Mouse and Keyboard Control.	90
Right-Click	90
PC Keyboard.	92

3. About the Phase Noise Measurement Application

4. Programming the Analyzer

What Programming Information is Available?.	98
STATus Subsystem (No equivalent front-panel keys)	99

Contents

Detailed Description	101
STATus Subsystem Command Descriptions	111
IEEE Common GPIB Commands	141
Calibration Query	141
Clear Status	141
Standard Event Status Enable	141
Standard Event Status Register Query	142
Identification Query	142
Operation Complete	143
Query Instrument Options	143
Recall Instrument State	144
Save Instrument State	144
Service Request Enable	145
Status Byte Query	145
Trigger	146
Self Test Query	146
Wait-to-Continue	146

5. System Functions

File	148
File Explorer	148
Page Setup	148
Print	148
Exit	149
Preset	150
Mode Preset	150
Restore Mode Defaults	152
*RST (Remote Command Only)	152
Print	153
Quick Save	154
Recall	156
Save	157
System	158
Show	158
Power On	166
Configure Applications	169
Alignments	173
I/O Config	197
Restore Defaults	238
Control Panel...	243
Licensing.....	243
Agilent Upgrade Service	245
Service	246
Diagnostics	246
List installed Options (Remote Command Only)	250
Lock the Front-panel keys (Remote Command Only)	250
List SCPI Commands (Remote Command Only)	251
SCPI Version Query (Remote Command Only)	251
Date (Remote Command Only)	251

Time (Remote Command Only)	252
User Preset	253
User Preset.	253
User Preset All Modes.	254
Save User Preset	255

6. Monitor Spectrum Measurement

AMPTD Y Scale	258
Ref Value	258
Attenuation	259
Scale/Div	259
Presel Center	259
Presel Adjust	260
Internal Preamp	260
Ref Position	260
Auto Scaling	260
Auto Couple	262
BW	263
Res BW	263
Video BW	264
VBW:3dB RBW	264
Span:3dB RBW	265
Cont.	267
FREQ Channel	268
Input/Output	269
Marker.	270
Select Marker	270
Marker Type	270
Properties.	272
Select Marker	272
Couple Markers	274
All Markers Off	274
Marker Function	275
Select Marker	275
Marker Function Type	275
Band Adjust.	276
Marker To	278
Meas	279
Meas Setup	280
Avg/Hold Num	280
Avg Mode	280
Meas Preset	281
Mode	282
Mode Setup	283
Peak Search.	284
Recall	285
Restart.	286
Save.	287
Single	288

Contents

Source	289
Span X Scale	290
Span	290
Full Span	291
Last Span	291
Sweep/Control	292
Sweep Time	292
Pause	292
Gate	293
Points	293
Trace/Detector	294
Select Trace	294
Trace Type	294
Update	295
Display	295
Detector	296
Clear Trace	297
Clear All Traces	298
View/Display	299
Display	299

7. Spot Frequency Measurement

AMPTD Y Scale	302
Ref Value	302
Attenuation	303
Scale/Div	303
Presel Center	305
Presel Adjust	305
Internal Preamp	305
Auto Scale	306
Auto Couple	307
BW	308
Res BW	308
Video BW	308
VBW:3dB RBW	309
Cont	310
FREQ Channel	311
Input/Output	312
Marker	313
Marker Fctn	314
Marker To	315
Meas	316
Meas Setup	317
Avg/Hold Num	317
Avg Mode	317
Meas Type	318
Spot Offset	319
Table Index	319
Advanced	320

Contents

Meas Preset	320
Mode	321
Mode Setup	322
Peak Search	323
Recall	324
Restart	325
Save	326
Single	327
Source	328
SPAN X Scale	329
Sweep/Control	330
Sweep Time	330
Trace/Detector	331
Trigger	332
View/Display	333
Display	333
Graphical View	333
Numerical (Table View)	335
View – Selection by Enum (Remote Command Only)	335
View – Selection by number (Remote Command Only)	336

8. Log Plot Measurement

AMPTD Y Scale	339
Ref Value	339
Attenuation	339
Scale/Div	339
Presel Center	340
Presel Adjust	340
Internal Preamp	340
Ref Position	341
Auto Couple	342
BW	343
Cont	344
FREQ Channel	345
Input/Output	346
Marker	347
Select Marker	347
Marker Type	347
Marker X Axis Value (Remote Command Only)	348
Marker X Axis Position (Remote Command Only)	349
Marker Y Axis Value (Remote Command Only)	350
Properties	350
Marker Table	352
Couple Marker	352
All Markers Off	353
Marker Function	354
Select Marker	354
Marker Function Type	354
RMS Noise (Units)	355

Contents

Band Adjust	355
Marker To	358
Meas	359
Meas Setup	360
Avg Number	360
Avg Mode	360
Meas Type	361
Smoothing	362
Decade Table	362
Cancellation	363
Ref Trace	363
Threshold Δ	364
Advanced	364
Meas Preset	365
Mode	366
Mode Setup	367
Peak Search	368
Recall	369
Restart	370
Save	371
Single	372
Source	373
SPAN X Scale	374
Start Offset	374
Stop Offset	375
Sweep/Control	376
Trace/Detector	377
Select Trace	377
Trace Type	377
Detector	377
Copy/Exchange	378
Trigger	380
View/Display	381
Display	381

9. Waveform Measurement

AMPTD Y Scale	385
Ref Value	385
Attenuation	386
Range	387
Scale/Div	387
Presel Center	388
Presel Adjust	389
Internal Preamp	389
Ref Position	389
Auto Scaling	390
Auto Couple	392
BW	393
Info BW	393

IBW Control	394
Cont.	402
FREQ Channel	403
Input/Output	404
Marker	405
Select Marker	405
Marker Type	405
Marker X Axis Value (Remote Command only)	406
Marker X Axis Position (Remote Command only)	407
Marker Y Axis Value (Remote Command only)	407
Properties	408
Couple Markers	410
All Markers Off	410
Marker Function	411
Select Marker	411
Marker Function Type	411
Band Adjust	412
Marker To	415
Meas	416
Meas Setup	417
Average/Hold Number	417
Avg Mode	417
Avg Type	418
Meas Time	419
Meas Preset	419
Advanced	420
Mode	423
Mode Setup	424
Peak Search	425
Next Peak	425
Min Search	425
Recall	427
Restart	428
Save	429
Single	430
Source	431
Span X Scale	432
Ref Value	432
Scale/Div	432
Ref Position	433
Auto Scaling	434
Sweep/Control	435
Pause and Resume	435
Trace/Detector	436
Trigger	437
View/Display	438
Display	439
RF Envelope	439
I/Q Waveform	440

10. Common Measurement Functions

Amplitude Y Scale (AMPTD Y Scale)	443
Attenuation	443
Range	450
Presel Center	455
Preselector Adjust	456
Internal Preamp	458
AUTO COUPLE	461
BW	463
Cont (Continuous Measurement/Sweep)	465
FREQ Channel	467
Auto Tune	467
Carrier Freq	467
Signal Track	468
Tracking	469
Input/Output	471
RF Input	472
I/Q	473
RF Calibrator	488
External Gain	490
Restore Input/Output Defaults	494
Data Source	494
Corrections	498
Freq Ref In	507
Output Config	512
I/Q Guided Calibration	516
Marker	529
Marker Function	531
Marker To	533
Meas	535
Remote Measurement Functions	535
Meas Setup	549
Mode	551
Application Mode Number Selection (Remote Command only)	552
Application Mode Catalog Query (Remote Command only)	553
Application Identification (Remote Commands only)	553
Application Identification Catalog (Remote Commands only)	554
Detailed List of Modes	556
Mode Setup	565
Restore Mode Defaults	565
Peak Search	567
Recall	569
State	569
Trace (+State)	573
Data (Mode Specific)	576
File Open Dialog and Menu	586
Restart	591
Save	593
State	593

Trace (+State)	596
Data (Mode Specific)	600
Screen Image	611
Save As	614
Single (Single Measurement/Sweep)	619
Source	621
SPAN X Scale	623
Sweep / Control	625
Abort (Remote Command Only)	625
Pause/Resume	626
Gate	626
Trace / Detector	639
Trigger	641
Free Run	648
Video (IF Envelope)	649
Line	651
External 1	652
External 2	654
RF Burst (Wideband)	656
Periodic Timer (Frame Trigger)	659
LXI Trigger	666
Baseband I/Q	682
Auto/Holdoff	693
Trigger Offset (Remote Command Only)	696
View/Display	697
Display	697
Full Screen	705
Display Enable (Remote Command Only)	706

List of Commands

*CAL?	181
*CLS	141
*ESE <integer>	141
*ESE?	141
*ESR?	142
*IDN?	143
*OPC?	143
*OPC	143
*OPT?	143
*RCL <register #>	144
*RST	152
*SAV <register #>	144
*SRE <integer>	145
*SRE?	145
*STB?	145
*TRG	146
*TST?	146
*WAI	146
:ABORt	625
:CALCulate:CLIMits:FAIL?	539
:CALCulate:DATA<n>:COMPRESS? BLOCK CFIT MAXimum MINimum MEAN DMEan RMS RM- SCubed SAMPLE SDEVIation PPHase [,<soffset>[,<length>[,<roffset>[,<rlimit>]]]]	540
:CALCulate:DATA[1] 2 3 4 5 6:PEAKs? <threshold>,<excursion>[,AMPLitude FREQuency TIME[,ALL GTD- Line LTDLine]]	545
:CALCulate:DATA[1] 2 3 4 5 6:PEAKs? <threshold>,<excursion>[,AMPLitude FREQuency TIME]	545
:CALCulate:DATA[n]?	539
:CALCulate:LPLot:DECade:TABLE[:STATe] OFF ON 0 1	362
:CALCulate:LPLot:DECade:TABLE[:STATe]?	362
:CALCulate:LPLot:MARKer:AOFF	353
:CALCulate:LPLot:MARKer:COUPle[:STATe] ON OFF 1 0	352
:CALCulate:LPLot:MARKer:COUPle[:STATe]?	352
:CALCulate:LPLot:MARKer:TABLE[:STATe] OFF ON 0 1	352

List of Commands

:CALCulate:LPLot:MARKer:TABLE[:STATE]?	352
:CALCulate:LPLot:MARKer[1] 2 3 4 5 6 7 8 9 10 11 12:BAND:LEFT <freq>	356
:CALCulate:LPLot:MARKer[1] 2 3 4 5 6 7 8 9 10 11 12:BAND:LEFT?	356
:CALCulate:LPLot:MARKer[1] 2 3 4 5 6 7 8 9 10 11 12:BAND:RIGHT <freq>	356
:CALCulate:LPLot:MARKer[1] 2 3 4 5 6 7 8 9 10 11 12:BAND:RIGHT?	356
:CALCulate:LPLot:MARKer[1] 2 3 4 5 6 7 8 9 10 11 12:BAND:SPAN <freq>	355
:CALCulate:LPLot:MARKer[1] 2 3 4 5 6 7 8 9 10 11 12:BAND:SPAN?	355
:CALCulate:LPLot:MARKer[1] 2 3 4 5 6 7 8 9 10 11 12:FUNCTION RMSNoise RFM OFF	354
:CALCulate:LPLot:MARKer[1] 2 3 4 5 6 7 8 9 10 11 12:FUNCTION?	354
:CALCulate:LPLot:MARKer[1] 2 3 4 5 6 7 8 9 10 11 12:MODE POSition DELTA OFF	348
:CALCulate:LPLot:MARKer[1] 2 3 4 5 6 7 8 9 10 11 12:MODE?	348
:CALCulate:LPLot:MARKer[1] 2 3 4 5 6 7 8 9 10 11 12:REFerence <integer>	351
:CALCulate:LPLot:MARKer[1] 2 3 4 5 6 7 8 9 10 11 12:REFerence?	351
:CALCulate:LPLot:MARKer[1] 2 3 4 5 6 7 8 9 10 11 12:RMSNoise:MODE DEGRee RADian JITTer	355
:CALCulate:LPLot:MARKer[1] 2 3 4 5 6 7 8 9 10 11 12:RMSNoise:MODE?	355
:CALCulate:LPLot:MARKer[1] 2 3 4 5 6 7 8 9 10 11 12:TRACe <integer>	351
:CALCulate:LPLot:MARKer[1] 2 3 4 5 6 7 8 9 10 11 12:TRACe?	351
:CALCulate:LPLot:MARKer[1] 2 3 4 5 6 7 8 9 10 11 12:X <freq>	348
:CALCulate:LPLot:MARKer[1] 2 3 4 5 6 7 8 9 10 11 12:X:POSition <integer>	349
:CALCulate:LPLot:MARKer[1] 2 3 4 5 6 7 8 9 10 11 12:X:POSition?	349
:CALCulate:LPLot:MARKer[1] 2 3 4 5 6 7 8 9 10 11 12:X?	348
:CALCulate:LPLot:MARKer[1] 2 3 4 5 6 7 8 9 10 11 12:Y?	350
:CALCulate:MONitor:MARKer:AOFF	274
:CALCulate:MONitor:MARKer:COUPle[:STATE] ON OFF 1 0	274
:CALCulate:MONitor:MARKer:COUPle[:STATE]?	274
:CALCulate:MONitor:MARKer[1] 2 3 4 5 6 7 8 9 10 11 12:FUNCTION NOISE BPOWer BDENsity OFF	275
:CALCulate:MONitor:MARKer[1] 2 3 4 5 6 7 8 9 10 11 12:FUNCTION:BAND:LEFT <freq>	276
:CALCulate:MONitor:MARKer[1] 2 3 4 5 6 7 8 9 10 11 12:FUNCTION:BAND:LEFT?	276
:CALCulate:MONitor:MARKer[1] 2 3 4 5 6 7 8 9 10 11 12:FUNCTION:BAND:RIGHT <freq>	277
:CALCulate:MONitor:MARKer[1] 2 3 4 5 6 7 8 9 10 11 12:FUNCTION:BAND:RIGHT?	277
:CALCulate:MONitor:MARKer[1] 2 3 4 5 6 7 8 9 10 11 12:FUNCTION:BAND:SPAN <freq>	276

List of Commands

:CALCulate:MONitor:MARKer[1] 2 3 4 5 6 7 8 9 10 11 12:FUNction:BAND:SPAN?	276
:CALCulate:MONitor:MARKer[1] 2 3 4 5 6 7 8 9 10 11 12:FUNction?	275
:CALCulate:MONitor:MARKer[1] 2 3 4 5 6 7 8 9 10 11 12:MODE POSition DELTA OFF	270
:CALCulate:MONitor:MARKer[1] 2 3 4 5 6 7 8 9 10 11 12:MODE?	270
:CALCulate:MONitor:MARKer[1] 2 3 4 5 6 7 8 9 10 11 12:REFerence <integer>	273
:CALCulate:MONitor:MARKer[1] 2 3 4 5 6 7 8 9 10 11 12:REFerence?	273
:CALCulate:MONitor:MARKer[1] 2 3 4 5 6 7 8 9 10 11 12:TRACe <integer>	273
:CALCulate:MONitor:MARKer[1] 2 3 4 5 6 7 8 9 10 11 12:TRACe?	273
:CALCulate:MONitor:MARKer[1] 2 3 4 5 6 7 8 9 10 11 12:X <freq>	271
:CALCulate:MONitor:MARKer[1] 2 3 4 5 6 7 8 9 10 11 12:X:POSition <real>	271
:CALCulate:MONitor:MARKer[1] 2 3 4 5 6 7 8 9 10 11 12:X:POSition?	271
:CALCulate:MONitor:MARKer[1] 2 3 4 5 6 7 8 9 10 11 12:X?	271
:CALCulate:MONitor:MARKer[1] 2 3 4 5 6 7 8 9 10 11 12:Y?	272
:CALCulate:WAVeform:MARKer:AOFF	410
:CALCulate:WAVeform:MARKer:COUPlE[:STATe] ON OFF 1 0	410
:CALCulate:WAVeform:MARKer:COUPlE[:STATe]?	410
:CALCulate:WAVeform:MARKer[1] 2 3 4 5 6 7 8 9 10 11 12:FUNction BPOWer BDENsity OFF	411
:CALCulate:WAVeform:MARKer[1] 2 3 4 5 6 7 8 9 10 11 12:FUNction:BAND:LEFT <time>	413
:CALCulate:WAVeform:MARKer[1] 2 3 4 5 6 7 8 9 10 11 12:FUNction:BAND:LEFT?	413
:CALCulate:WAVeform:MARKer[1] 2 3 4 5 6 7 8 9 10 11 12:FUNction:BAND:RIGHT <time>	413
:CALCulate:WAVeform:MARKer[1] 2 3 4 5 6 7 8 9 10 11 12:FUNction:BAND:RIGHT?	413
:CALCulate:WAVeform:MARKer[1] 2 3 4 5 6 7 8 9 10 11 12:FUNction:BAND:SPAN <time>	412
:CALCulate:WAVeform:MARKer[1] 2 3 4 5 6 7 8 9 10 11 12:FUNction:BAND:SPAN?	412
:CALCulate:WAVeform:MARKer[1] 2 3 4 5 6 7 8 9 10 11 12:FUNction?	411
:CALCulate:WAVeform:MARKer[1] 2 3 4 5 6 7 8 9 10 11 12:MAXimum	425
:CALCulate:WAVeform:MARKer[1] 2 3 4 5 6 7 8 9 10 11 12:MAXimum:NEXT	425
:CALCulate:WAVeform:MARKer[1] 2 3 4 5 6 7 8 9 10 11 12:MINimum	425
:CALCulate:WAVeform:MARKer[1] 2 3 4 5 6 7 8 9 10 11 12:MODE POSition DELTA OFF	405
:CALCulate:WAVeform:MARKer[1] 2 3 4 5 6 7 8 9 10 11 12:MODE?	405
:CALCulate:WAVeform:MARKer[1] 2 3 4 5 6 7 8 9 10 11 12:REFerence <integer>	408
:CALCulate:WAVeform:MARKer[1] 2 3 4 5 6 7 8 9 10 11 12:REFerence?	408

List of Commands

:CALCulate:WAVEform:MARKer[1] 2 3 4 5 6 7 8 9 10 11 12:TRACe RFENvelope IQ	409
:CALCulate:WAVEform:MARKer[1] 2 3 4 5 6 7 8 9 10 11 12:TRACe?	409
:CALCulate:WAVEform:MARKer[1] 2 3 4 5 6 7 8 9 10 11 12:X <time>	406
:CALCulate:WAVEform:MARKer[1] 2 3 4 5 6 7 8 9 10 11 12:X:POSition <real>	407
:CALCulate:WAVEform:MARKer[1] 2 3 4 5 6 7 8 9 10 11 12:X:POSition?	407
:CALCulate:WAVEform:MARKer[1] 2 3 4 5 6 7 8 9 10 11 12:X?	406
:CALCulate:WAVEform:MARKer[1] 2 3 4 5 6 7 8 9 10 11 12:Y?	407
:CALibration:AUTO ON PARTial OFF ALERT	173
:CALibration:AUTO:ALERT TTEMPerature DAY WEEK NONE	177
:CALibration:AUTO:ALERT?	177
:CALibration:AUTO:MODE ALL NRF	176
:CALibration:AUTO:MODE?	176
:CALibration:AUTO:TIME:OFF?	188
:CALibration:AUTO?	173
:CALibration:DATA:BACKup <filename>	196
:CALibration:DATA:DEFault	191
:CALibration:DATA:RESTore <filename>	196
:CALibration:FREQuency:REFerence:COARse <integer>	190
:CALibration:FREQuency:REFerence:COARse?	190
:CALibration:FREQuency:REFerence:FINE <integer>	189
:CALibration:FREQuency:REFerence:FINE?	189
:CALibration:FREQuency:REFerence:MODE CALibrated USER	188
:CALibration:FREQuency:REFerence:MODE?	188
:CALibration:IQ:FLATness:I	518
:CALibration:IQ:FLATness:I IBAR Q QBAR:TIME?	522
:CALibration:IQ:FLATness:IBAR	519
:CALibration:IQ:FLATness:Q	520
:CALibration:IQ:FLATness:QBAR	521
:CALibration:IQ:ISOLation	516
:CALibration:IQ:ISOLation:TIME?	517
:CALibration:IQ:PROBe:I	523

List of Commands

:CALibration:IQ:PROBe:I IBAR Q QBAR:TIME?	528
:CALibration:IQ:PROBe:I Q:CLEar	487
:CALibration:IQ:PROBe:IBar	525
:CALibration:IQ:PROBe:Q	526
:CALibration:IQ:PROBe:QBar	527
:CALibration:NRF?	182
:CALibration:NRF	182
:CALibration:RF?	183
:CALibration:RF	183
:CALibration:TEMPerature:CURRent?	186
:CALibration:TEMPerature:LALL?	187
:CALibration:TEMPerature:LPReselector?	188
:CALibration:TEMPerature:LRF?	187
:CALibration:TIME:LALL?	186
:CALibration:TIME:LPReselector?	187
:CALibration:TIME:LRF?	187
:CALibration:YTF?	184
:CALibration:YTF	184
:CALibration[:ALL]?	180
:CALibration[:ALL]	180
:CONFigure:LPLot	365
:CONFigure:LPLot:NDEFault	337
:CONFigure:LPLot	337
:CONFigure:MONitor	281
:CONFigure:MONitor:NDEFault	257
:CONFigure:MONitor	257
:CONFigure:SFRequency	320
:CONFigure:SFRequency:NDEFault	301
:CONFigure:SFRequency	301
:CONFigure:WAVeform	419
:CONFigure:WAVeform:NDEFault	383

List of Commands

:CONFigure:WAVeform	383
:CONFigure?	539
:COUple ALL NONE	461
:DISPlay:<measurement>:ANNotation:TITLe:DATA <string>	701
:DISPlay:<measurement>:ANNotation:TITLe:DATA?	701
:DISPlay:ACTivefunc[:STATe] ON OFF 1 0	700
:DISPlay:ACTivefunc[:STATe]?	700
:DISPlay:ANNotation:MBAR[:STATe] OFF ON 0 1	698
:DISPlay:ANNotation:MBAR[:STATe]?	698
:DISPlay:ANNotation:SCREen[:STATe] OFF ON 0 1	699
:DISPlay:ANNotation:SCREen[:STATe]?	699
:DISPlay:ANNotation:TRACe[:STATe] ON OFF 1 0	699
:DISPlay:ANNotation:TRACe[:STATe]?	699
:DISPlay:BACKlight ON OFF	704
:DISPlay:BACKlight:INTensity <integer>	705
:DISPlay:BACKlight:INTensity?	705
:DISPlay:BACKlight?	704
:DISPlay:ENABle OFF ON 0 1	706
:DISPlay:ENABle?	706
:DISPlay:FSCReen[:STATe] OFF ON 0 1	706
:DISPlay:FSCReen[:STATe]?	706
:DISPlay:LPLot:VIEW[1]:WINDow[1]:TRACe:Y[:SCALe]:PDIVision <rel_ampl>	340
:DISPlay:LPLot:VIEW[1]:WINDow[1]:TRACe:Y[:SCALe]:PDIVision?	340
:DISPlay:LPLot:VIEW[1]:WINDow[1]:TRACe:Y[:SCALe]:RLEVel <real>	339
:DISPlay:LPLot:VIEW[1]:WINDow[1]:TRACe:Y[:SCALe]:RLEVel?	339
:DISPlay:LPLot:VIEW[1]:WINDow[1]:TRACe:Y[:SCALe]:RPOSition TOP CENTer BOTTom	341
:DISPlay:LPLot:VIEW[1]:WINDow[1]:TRACe:Y[:SCALe]:RPOSition?	341
:DISPlay:MONitor:VIEW:WINDow:TRACe[1] 2 3:CLEar	297
:DISPlay:MONitor:VIEW[1]:WINDow[1]:TRACe:Y[:SCALe]:COUple 0 1 OFF ON	261
:DISPlay:MONitor:VIEW[1]:WINDow[1]:TRACe:Y[:SCALe]:COUple?	261
:DISPlay:MONitor:VIEW[1]:WINDow[1]:TRACe:Y[:SCALe]:PDIVision <rel_ampl>	259

List of Commands

:DISPlay:MONitor:VIEW[1]:WINDow[1]:TRACe:Y[:SCALe]:PDIVision?	259
:DISPlay:MONitor:VIEW[1]:WINDow[1]:TRACe:Y[:SCALe]:RLEVel <real>	258
:DISPlay:MONitor:VIEW[1]:WINDow[1]:TRACe:Y[:SCALe]:RLEVel?	258
:DISPlay:MONitor:VIEW[1]:WINDow[1]:TRACe:Y[:SCALe]:RPOSition TOP CENTer BOTTom	260
:DISPlay:MONitor:VIEW[1]:WINDow[1]:TRACe:Y[:SCALe]:RPOSition?	260
:DISPlay:SFRequency:VIEW:NSElect 1 2	336
:DISPlay:SFRequency:VIEW:NSElect?	336
:DISPlay:SFRequency:VIEW:WINDow[1] 2:TRACe:Y[:SCALe]:COUPlE 0 1 OFF ON	306
:DISPlay:SFRequency:VIEW:WINDow[1] 2:TRACe:Y[:SCALe]:COUPlE?	306
:DISPlay:SFRequency:VIEW[:SElect] GRAPh TABLe	335
:DISPlay:SFRequency:VIEW[:SElect]?	335
:DISPlay:SFRequency:VIEW[1]:WINDow[1]:TRACe:Y[:SCALe]:PDIVision <rel_ampl>	304
:DISPlay:SFRequency:VIEW[1]:WINDow[1]:TRACe:Y[:SCALe]:PDIVision?	304
:DISPlay:SFRequency:VIEW[1]:WINDow[1]:TRACe:Y[:SCALe]:RLEVel <real>	302
:DISPlay:SFRequency:VIEW[1]:WINDow[1]:TRACe:Y[:SCALe]:RLEVel?	302
:DISPlay:SFRequency:VIEW[1]:WINDow2:TRACe:Y[:SCALe]:PDIVision <freq>	304
:DISPlay:SFRequency:VIEW[1]:WINDow2:TRACe:Y[:SCALe]:PDIVision?	304
:DISPlay:SFRequency:VIEW[1]:WINDow2:TRACe:Y[:SCALe]:RLEVel <freq>	303
:DISPlay:SFRequency:VIEW[1]:WINDow2:TRACe:Y[:SCALe]:RLEVel?	303
:DISPlay:SFRequency:VIEW2:WINDow[1]:TRACe:Y[:SCALe]:RLEVel <integer>	319
:DISPlay:SFRequency:VIEW2:WINDow[1]:TRACe:Y[:SCALe]:RLEVel?	319
:DISPlay:THEMe TDColor TDMonochrome FCOLor FMONochrome	704
:DISPlay:THEMe?	704
:DISPlay:WAVeform:VIEW:NSElect <integer>	438
:DISPlay:WAVeform:VIEW:NSElect?	438
:DISPlay:WAVeform:VIEW[:SElect] RFENvelope IQ	438
:DISPlay:WAVeform:VIEW[:SElect]?	438
:DISPlay:WAVeform:VIEW[1]:WINDow[1]:TRACe:Y[:SCALe]:PDIVision <rel_ampl>	387
:DISPlay:WAVeform:VIEW[1]:WINDow[1]:TRACe:Y[:SCALe]:PDIVision?	387
:DISPlay:WAVeform:VIEW[1]:WINDow[1]:TRACe:Y[:SCALe]:RLEVel <ampl>	385
:DISPlay:WAVeform:VIEW[1]:WINDow[1]:TRACe:Y[:SCALe]:RLEVel?	385

List of Commands

:DISPlay:WAVeform:VIEW[1]:WINDow[1]:TRACe:Y[:SCALe]:RPOSition TOP CENTer BOTTom	389
:DISPlay:WAVeform:VIEW[1]:WINDow[1]:TRACe:Y[:SCALe]:RPOSition?	389
:DISPlay:WAVeform:VIEW[1]2:WINDow[1]:TRACe:X[:SCALe]:COUPlE 0 1 OFF ON	434
:DISPlay:WAVeform:VIEW[1]2:WINDow[1]:TRACe:X[:SCALe]:COUPlE?	434
:DISPlay:WAVeform:VIEW[1]2:WINDow[1]:TRACe:X[:SCALe]:PDIVision <time>	433
:DISPlay:WAVeform:VIEW[1]2:WINDow[1]:TRACe:X[:SCALe]:PDIVision?	433
:DISPlay:WAVeform:VIEW[1]2:WINDow[1]:TRACe:X[:SCALe]:RLEVel <time>	432
:DISPlay:WAVeform:VIEW[1]2:WINDow[1]:TRACe:X[:SCALe]:RLEVel?	432
:DISPlay:WAVeform:VIEW[1]2:WINDow[1]:TRACe:X[:SCALe]:RPOSition LEFT CENTer RIGHT	433
:DISPlay:WAVeform:VIEW[1]2:WINDow[1]:TRACe:X[:SCALe]:RPOSition?	433
:DISPlay:WAVeform:VIEW[1]2:WINDow[1]:TRACe:Y[:SCALe]:COUPlE 0 1 OFF ON	390
:DISPlay:WAVeform:VIEW[1]2:WINDow[1]:TRACe:Y[:SCALe]:COUPlE?	390
:DISPlay:WAVeform:VIEW2:WINDow[1]:TRACe:Y[:SCALe]:PDIVision <voltage>.	388
:DISPlay:WAVeform:VIEW2:WINDow[1]:TRACe:Y[:SCALe]:PDIVision?	388
:DISPlay:WAVeform:VIEW2:WINDow[1]:TRACe:Y[:SCALe]:RLEVel <voltage>	386
:DISPlay:WAVeform:VIEW2:WINDow[1]:TRACe:Y[:SCALe]:RLEVel?	386
:DISPlay:WAVeform:VIEW2:WINDow[1]:TRACe:Y[:SCALe]:RPOSition TOP CENTer BOTTom.	390
:DISPlay:WAVeform:VIEW2:WINDow[1]:TRACe:Y[:SCALe]:RPOSition?	390
:DISPlay:WINDow:FORMat:TILE	89
:DISPlay:WINDow:FORMat:ZOOM	88
:DISPlay:WINDow[:SElect] <number>.	89
:DISPlay:WINDow[:SElect]?	89
:DISPlay:WINDow[1]:ANNotation[:ALL] OFF ON 0 1.	703
:DISPlay:WINDow[1]:ANNotation[:ALL]?	703
:DISPlay:WINDow[1]:TRACe:GRATicule:GRID[:STATe] OFF ON 0 1.	702
:DISPlay:WINDow[1]:TRACe:GRATicule:GRID[:STATe]?	702
:DISPlay:WINDow[1]:TRACe:Y:DLINe <ampl>	703
:DISPlay:WINDow[1]:TRACe:Y:DLINe:STATe OFF ON 0 1	703
:DISPlay:WINDow[1]:TRACe:Y:DLINe:STATe?	703
:DISPlay:WINDow[1]:TRACe:Y:DLINe?	703
:FETCh:LPLot[n]?	337

List of Commands

:FETCh:MONitor[n]?	257
:FETCh:SFRequency[n]?	301
:FETCh:WAVeform[n]	383
:FORMat:BORDER NORMAl SWAPped	547
:FORMat:BORDER?	547
:FORMat[:TRACe][:DATA] ASCii INTEger,32 REAL,32 REAL,64	546
:FORMat[:TRACe][:DATA]?	546
:INITiate:CONTInuous OFF ON 0 1	465
:INITiate:CONTInuous?	465
:INITiate:LPLot	337
:INITiate:MONitor	257
:INITiate:PAUSe.	626
:INITiate:REStart.	591
:INITiate:RESume	626
:INITiate:SFRequency	301
:INITiate:WAVeform.	383
:INITiate[:IMMEdiate]	591
:INPut:COUPling AC DC	473
:INPut:COUPling:I Q DC LFR1 LFR2	486
:INPut:COUPling:I Q?	486
:INPut:COUPling?	473
:INPut:IMPedance:IQ U50 B50 U1M B1M	480
:INPut:IMPedance:IQ?	480
:INPut:IMPedance:REFErence <integer>	488
:INPut:IMPedance:REFErence?	488
:INPut:IQ:MIRRored OFF ON 0 1	481
:INPut:IQ:MIRRored?	481
:INPut:IQ:Q:DIFFerential OFF ON 0 1	482
:INPut:IQ:Q:DIFFerential?	482
:INPut:IQ[:I]:DIFFerential OFF ON 0 1	478
:INPut:IQ[:I]:DIFFerential?	478

List of Commands

:INPut:OFFSet:I Q <voltage>	485
:INPut:OFFSet:I Q?	485
:INPut[1]:IQ:BALEnced[:STATe] OFF ON 0 1	478
:INPut[1]:IQ:BALEnced[:STATe]?	478
:INPut[1]:IQ:Q:IMPedance LOW HIGH	482
:INPut[1]:IQ:Q:IMPedance?	482
:INPut[1]:IQ:TYPE IQ I Q	477
:INPut[1]:IQ:TYPE?	477
:INPut[1]:IQ[:I]:IMPedance LOW HIGH	479
:INPut[1]:IQ[:I]:IMPedance?	479
:INSTRument:CATalog?	553
:INSTRument:DEFault	152
:INSTRument:NSElect <integer>	552
:INSTRument:NSElect?	552
:INSTRument[:SElect] SA BASIC ADEMOD NFIGURE PNOISE CDMA2K TDSCDMA VSA VSA89601 WCD- MA WIMAXOFDMA EDGE GSM CDMA1XEV RLC	551
:INSTRument[:SElect]?	551
:LXI:CLOCK:PTP:ACCuracy NS25 NS100 NS250 NS1000 NS2500 US10 US25 US100 US250 US1000 US2500 MS10 MS25 MS100 MS1000 S 10 GT10S UNKNown	217
:LXI:CLOCK:PTP:ACCuracy?	217
:LXI:CLOCK:PTP:ANNounce:INTerval <interval>	218
:LXI:CLOCK:PTP:ANNounce:INTerval?	218
:LXI:CLOCK:PTP:ANNounce:RTOut <numberOfIntervals>	218
:LXI:CLOCK:PTP:ANNounce:RTOut?	218
:LXI:CLOCK:PTP:CCLass?	218
:LXI:CLOCK:PTP:DEVIation?	219
:LXI:CLOCK:PTP:DOMain <domainNumber>	219
:LXI:CLOCK:PTP:DOMain?	219
:LXI:CLOCK:PTP:DRINterval <seconds>	222
:LXI:CLOCK:PTP:DRINterval?	222
:LXI:CLOCK:PTP:GMASter:ACCuracy?	222

List of Commands

:LXI:CLOCK:PTP:GMASter:MADDDress?	222
:LXI:CLOCK:PTP:GMASter:TRACeability?	223
:LXI:CLOCK:PTP:MASter:MADDDress?	223
:LXI:CLOCK:PTP:OFFSet?	219
:LXI:CLOCK:PTP:PRIority:FIRSt <priority>	220
:LXI:CLOCK:PTP:PRIority:FIRSt?	220
:LXI:CLOCK:PTP:PRIority:SECond <priority>	220
:LXI:CLOCK:PTP:PRIority:SECond?	220
:LXI:CLOCK:PTP:SINterval <seconds>	221
:LXI:CLOCK:PTP:SINterval?	221
:LXI:CLOCK:PTP:STATe?	220
:LXI:CLOCK:PTP:TRACeability?	221
:LXI:CLOCK:PTP:VARiance?	221
:LXI:CLOCK:SALGorithm:LOG:ALL?	225
:LXI:CLOCK:SALGorithm:LOG:CIRCular:FBENtry	224
:LXI:CLOCK:SALGorithm:LOG:CIRCular[:ENABled] ON OFF 0 1	224
:LXI:CLOCK:SALGorithm:LOG:CIRCular[:ENABled]?	224
:LXI:CLOCK:SALGorithm:LOG:CLEar	224
:LXI:CLOCK:SALGorithm:LOG:COUNT?	224
:LXI:CLOCK:SALGorithm:LOG:ENABled ON OFF 0 1	225
:LXI:CLOCK:SALGorithm:LOG:ENABled?	225
:LXI:CLOCK:SALGorithm:LOG:ENTry? <intIndex>	226
:LXI:CLOCK:SALGorithm:LOG:SIZE <maxLogEntries>	225
:LXI:CLOCK:SALGorithm:LOG:SIZE?	225
:LXI:CLOCK:SALGorithm:LOG:STATistics:CLEar	226
:LXI:CLOCK:SALGorithm:LOG:STATistics[:DATA]?	226
:LXI:CLOCK:SALGorithm:LOG[:NEXT]?	223
:LXI:CLOCK:SALGorithm[:SET]:ASYMmetry <seconds>	226
:LXI:CLOCK:SALGorithm[:SET]:ASYMmetry?	226
:LXI:CLOCK:SALGorithm[:SET]:CFTHreshold <secondsSquared>	227
:LXI:CLOCK:SALGorithm[:SET]:CFTHreshold?	227

List of Commands

:LXI:CLOCK:SALGorithm[:SET]:CIConstant <servoConstant>	228
:LXI:CLOCK:SALGorithm[:SET]:CIConstant?	228
:LXI:CLOCK:SALGorithm[:SET]:CONFigure <asymmetry>, <coarse fine threshold>, <cpc>, <cic>, <fpc>, <fic>, <maximum outlier discard>, <outlier threshold>, <set/steer threshold>.	231
:LXI:CLOCK:SALGorithm[:SET]:CPCConstant <servoConstant>	227
:LXI:CLOCK:SALGorithm[:SET]:CPCConstant?	227
:LXI:CLOCK:SALGorithm[:SET]:FIConstant <servoConstant>	229
:LXI:CLOCK:SALGorithm[:SET]:FIConstant?	229
:LXI:CLOCK:SALGorithm[:SET]:FPCConstant <servoConstant>.	228
:LXI:CLOCK:SALGorithm[:SET]:FPCConstant?	228
:LXI:CLOCK:SALGorithm[:SET]:OMAXimum <consecutiveSamples>	229
:LXI:CLOCK:SALGorithm[:SET]:OMAXimum?	229
:LXI:CLOCK:SALGorithm[:SET]:OTENable ON OFF 1 0	230
:LXI:CLOCK:SALGorithm[:SET]:OTENable?	230
:LXI:CLOCK:SALGorithm[:SET]:OTHReshold <standardDeviations>	230
:LXI:CLOCK:SALGorithm[:SET]:OTHReshold?	230
:LXI:CLOCK:SALGorithm[:SET]:STHReshold <seconds>	230
:LXI:CLOCK:SALGorithm[:SET]:STHReshold?	230
:LXI:CLOCK:SYNC:LOCAl:ENABled ON OFF 0 1	231
:LXI:CLOCK:SYNC:LOCAl:ENABled?	231
:LXI:CLOCK:SYNC:LOCAl:INTerval?	232
:LXI:CLOCK:SYNC:LOCAl:INTerval	232
:LXI:CLOCK:SYNC:MASTer?	231
:LXI:CLOCK[:TIME]:DLSavings?	214
:LXI:CLOCK[:TIME]:FRACtion <fraction>.	213
:LXI:CLOCK[:TIME]:FRACtion?	213
:LXI:CLOCK[:TIME]:LOCAl?	213
:LXI:CLOCK[:TIME]:LSOFFset <integer>	214
:LXI:CLOCK[:TIME]:LSOFFset?	214
:LXI:CLOCK[:TIME]:MARKer[1] 2 3 4 5 6 7 8 9:CLEAr	215
:LXI:CLOCK[:TIME]:MARKer[1] 2 3 4 5 6 7 8 9:DELTA?	216

List of Commands

:LXI:CLOCK[:TIME]:MARKer[1] 2 3 4 5 6 7 8 9[:SET].	215
:LXI:CLOCK[:TIME]:MEASure:CLear	217
:LXI:CLOCK[:TIME]:MEASure[:DELTA]?	217
:LXI:CLOCK[:TIME]:SEConds <seconds>.	213
:LXI:CLOCK[:TIME]:SEConds?	213
:LXI:CLOCK[:TIME]:TAI?	214
:LXI:CLOCK[:TIME]:TZONe?	214
:LXI:CLOCK[:TIME]:UTC?	215
:LXI:CLOCK[:TIME][:VALue] <seconds>,<fractionalSeconds>	212
:LXI:CLOCK[:TIME][:VALue]?	212
:LXI:EVENT:DOMain <intDomain>	204
:LXI:EVENT:DOMain?	204
:LXI:EVENT:INPut:LAN:ADD "LANEVENT"	234
:LXI:EVENT:INPut:LAN:COUNt?	237
:LXI:EVENT:INPut:LAN:DISable:ALL	233
:LXI:EVENT:INPut:LAN:FILTer "LANEVENT", "filterString"	235
:LXI:EVENT:INPut:LAN:FILTer?	235
:LXI:EVENT:INPut:LAN:IDENtifier "LANEVENT", "identifier"	235
:LXI:EVENT:INPut:LAN:IDENtifier? "LANEVENT"	235
:LXI:EVENT:INPut:LAN:LIST?	237
:LXI:EVENT:INPut:LAN:LOCation "LANEVENT", "path"	233
:LXI:EVENT:INPut:LAN:LOCation? "LANEVENT"	233
:LXI:EVENT:INPut:LAN:REMOve:ALL	234
:LXI:EVENT:INPut:LAN:REMOve[:EVENT] "LANEVENT"	234
:LXI:EVENT:INPut:LAN[:SET]:CONFigure "lanEvent", <enab>, <detection>, <filter>, <identifier>	238
:LXI:EVENT:INPut:LAN[:SET]:DETection "LANEVENT", HIGH LOW RISE FALL	236
:LXI:EVENT:INPut:LAN[:SET]:DETection? "LANEVENT"	236
:LXI:EVENT:INPut:LAN[:SET]:ENABled "LANEVENT", ON OFF 1 0	237
:LXI:EVENT:INPut:LAN[:SET]:ENABled? "LANEVENT"	237
:LXI:EVENT:LOG:ALL?	166
:LXI:EVENT:LOG:CIRCular:FBENtry	166

List of Commands

:LXI:EVENT:LOG:CIRCular[:ENABle] ON OFF 1 0	164
:LXI:EVENT:LOG:CIRCular[:ENABle]?	164
:LXI:EVENT:LOG:CLEar	164
:LXI:EVENT:LOG:COUNt?	165
:LXI:EVENT:LOG:ENABle ON OFF 1 0	165
:LXI:EVENT:LOG:ENABle?	165
:LXI:EVENT:LOG:ENTRy? <intIndex>	166
:LXI:EVENT:LOG:SIZE <size>	164
:LXI:EVENT:LOG:SIZE?	164
:LXI:EVENT:LOG[:NEXT]?	165
:LXI:EVENT:STATus[:ENABled] "STATUSEVENT",ON OFF 1 0	232
:LXI:EVENT:STATus[:ENABled]? "STATUSEVENT"	232
:LXI:EVENT[:OUTPut]:LAN:ADD "LANEVENT"	205
:LXI:EVENT[:OUTPut]:LAN:COUNt?	210
:LXI:EVENT[:OUTPut]:LAN:DISAbLe:ALL	204
:LXI:EVENT[:OUTPut]:LAN:LIST?	204
:LXI:EVENT[:OUTPut]:LAN:REMOve:ALL	206
:LXI:EVENT[:OUTPut]:LAN:REMOve[:EVENT] "LANEVENT"	205
:LXI:EVENT[:OUTPut]:LAN:SENd "LANEVENT", RISE FALL	211
:LXI:EVENT[:OUTPut]:LAN[:SET]:CONFIgure "lanEvent",<enabled>,<source>,<slope>,<drive>,<destination> 211	
:LXI:EVENT[:OUTPut]:LAN[:SET]:DESTination "LANEVENT", "destinationExpression"	208
:LXI:EVENT[:OUTPut]:LAN[:SET]:DESTination? "LANEVENT"	208
:LXI:EVENT[:OUTPut]:LAN[:SET]:DRIVE "LANEVENT", OFF NORMal WOR	208
:LXI:EVENT[:OUTPut]:LAN[:SET]:DRIVE? "LANEVENT"	208
:LXI:EVENT[:OUTPut]:LAN[:SET]:ENABled "LANEVENT",ON OFF 1 0	210
:LXI:EVENT[:OUTPut]:LAN[:SET]:ENABled? "LANEVENT"	210
:LXI:EVENT[:OUTPut]:LAN[:SET]:IDENtifier "LANEVENT", "identifier"	211
:LXI:EVENT[:OUTPut]:LAN[:SET]:IDENtifier? "LANEVENT"	211
:LXI:EVENT[:OUTPut]:LAN[:SET]:SLOPe "LANEVENT", POSitive NEGative	209
:LXI:EVENT[:OUTPut]:LAN[:SET]:SLOPe? "LANEVENT"	209

List of Commands

:LXI:EVENT[:OUTPut]:LAN[:SET]:SOURce "LANEVENT", "SourceEvent"	207
:LXI:EVENT[:OUTPut]:LAN[:SET]:SOURce? "LANEVENT"	207
:LXI:EVENT[:OUTPut]:LAN[:SET]:TSDelta "LANEVENT", <seconds>	210
:LXI:EVENT[:OUTPut]:LAN[:SET]:TSDelta? "LANEVENT"	210
:MEASure:LPLot[n]?	337
:MEASure:MONitor[n]?	257
:MEASure:SFRequency[n]?	301
:MEASure:WAVEform[n]	383
:MMEMory:LOAD:CAPTured <filename>	585
:MMEMory:LOAD:CORRection 1 2 3 4, <filename>	585
:MMEMory:LOAD:LIMit LLINE1 LLINE2,<filename>	585
:MMEMory:LOAD:RECORDing <filename>	586
:MMEMory:LOAD:STATe <filename>	572
:MMEMory:LOAD:TRACe TRACE1 TRACE2 TRACE3 TRACE4 TRACE5 TRACE6,<filename>	576
:MMEMory:LOAD:TRACe:DATA D1 D2 D3 D4 D5 D6,<filename>[,CSV TXT SDF]	584
:MMEMory:LOAD:TRACe:DATA TRACE1 TRACE2 TRACE3 TRACE4 TRACE5 TRACE6,<filename>	584
:MMEMory:LOAD:TRACe:REGister TRACE1 TRACE2 TRACE3 TRACE4 TRACE5 TRACE6,<integer>	576
:MMEMory:LOAD:ZMAP <filename>	586
:MMEMory:STORE:CAPTured <filename>	610
:MMEMory:STORE:CORRection 1 2 3 4, <filename>	608
:MMEMory:STORE:LIMit LLINE1 LLINE2,<filename>	609
:MMEMory:STORE:RECORDing <filename>[,SDF SD- FX CSV TXT MAT4 MAT HDF5 BIN[,OFF ON 0 1[,OFF ON 0 1[,OFF ON 0 1]]]	610
:MMEMory:STORE:RESults <filename>	607
:MMEMory:STORE:RESults:MTABLE PTABLE <filename>	607
:MMEMory:STORE:SCReen <filename>	614
:MMEMory:STORE:SCReen:THEMe TDColor TDMonochrome FCOLOR FMONochrome	612
:MMEMory:STORE:SCReen:THEMe?	612
:MMEMory:STORE:STATe <filename>	596
:MMEMory:STORE:TRACe TRACE1 TRACE2 TRACE3 TRACE4 TRACE5 TRACE6 ALL,<filename>	599
:MMEMory:STORE:TRACe:DATA TRACE1 TRACE2 TRACE3 TRACE4 TRACE5 TRACE6,"<filena- me>"[,CSV TXT SDF[,OFF ON 0 1]	609

List of Commands

:MMEMory:STORe:TRACe:DATA TRACE1 TRACE2 TRACE3 TRACE4 TRACE5 TRACE6 ALL,<filename> 608	
:MMEMory:STORe:TRACe:REGister TRACE1 TRACE2 TRACE3 TRACE4 TRACE5 TRACE6 ALL,<integer> 599	
:MMEMory:STORe:ZMAP <filename>	610
:OUTPut:DBUS[1][:STATe] ON OFF 1 0	515
:OUTPut:DBUS[1][:STATe]?	515
:OUTPut:IQ:OUTPut IQ1 IQ250 OFF.	515
:OUTPut:IQ:OUTPut?	515
:READ:LPLot[n]?	337
:READ:MONitor[n]?	257
:READ:SFRequency[n]?	301
:READ:WAVEform[n]	383
:STATus:OPERation:CONDition?	111
:STATus:OPERation:ENABle <integer>	112
:STATus:OPERation:ENABle?	112
:STATus:OPERation:NTRansition <integer>	113
:STATus:OPERation:NTRansition?	113
:STATus:OPERation:PTRansition <integer>	113
:STATus:OPERation:PTRansition?	113
:STATus:OPERation[:EVENT]?	112
:STATus:PRESet	114
:STATus:QUEStionable:CALibration:CONDition?	116
:STATus:QUEStionable:CALibration:ENABle <integer>	117
:STATus:QUEStionable:CALibration:ENABle?	117
:STATus:QUEStionable:CALibration:EXTended:FAILure:CONDition?	121
:STATus:QUEStionable:CALibration:EXTended:FAILure:ENABle <integer>	121
:STATus:QUEStionable:CALibration:EXTended:FAILure:ENABle?	121
:STATus:QUEStionable:CALibration:EXTended:FAILure:NTRansition <integer>.	122
:STATus:QUEStionable:CALibration:EXTended:FAILure:NTRansition?	122
:STATus:QUEStionable:CALibration:EXTended:FAILure:PTRansition <integer>	123
:STATus:QUEStionable:CALibration:EXTended:FAILure:PTRansition?	123

List of Commands

:STATUS:QUESTIONable:CALibration:EXTended:FAILure[:EVENT]?	122
:STATUS:QUESTIONable:CALibration:EXTended:NEEDed:CONDition?	123
:STATUS:QUESTIONable:CALibration:EXTended:NEEDed:ENABle <integer>	124
:STATUS:QUESTIONable:CALibration:EXTended:NEEDed:ENABle?	124
:STATUS:QUESTIONable:CALibration:EXTended:NEEDed:NTRansition <integer>	125
:STATUS:QUESTIONable:CALibration:EXTended:NEEDed:NTRansition?	125
:STATUS:QUESTIONable:CALibration:EXTended:NEEDed:PTRansition <integer>	125
:STATUS:QUESTIONable:CALibration:EXTended:NEEDed:PTRansition?	125
:STATUS:QUESTIONable:CALibration:EXTended:NEEDed[:EVENT]?	124
:STATUS:QUESTIONable:CALibration:NTRansition <integer>	118
:STATUS:QUESTIONable:CALibration:NTRansition?	118
:STATUS:QUESTIONable:CALibration:PTRansition <integer>	118
:STATUS:QUESTIONable:CALibration:PTRansition?	118
:STATUS:QUESTIONable:CALibration:SKIPPed:CONDition?	119
:STATUS:QUESTIONable:CALibration:SKIPPed:ENABle <integer>	119
:STATUS:QUESTIONable:CALibration:SKIPPed:ENABle?	119
:STATUS:QUESTIONable:CALibration:SKIPPed:NTRansition <integer>	120
:STATUS:QUESTIONable:CALibration:SKIPPed:NTRansition?	120
:STATUS:QUESTIONable:CALibration:SKIPPed:PTRansition <integer>	120
:STATUS:QUESTIONable:CALibration:SKIPPed:PTRansition?	120
:STATUS:QUESTIONable:CALibration:SKIPPed[:EVENT]?	120
:STATUS:QUESTIONable:CALibration[:EVENT]?	117
:STATUS:QUESTIONable:CONDition?	114
:STATUS:QUESTIONable:ENABle 16	115
:STATUS:QUESTIONable:ENABle?	115
:STATUS:QUESTIONable:FREQuency:CONDition?	126
:STATUS:QUESTIONable:FREQuency:ENABle <integer>	126
:STATUS:QUESTIONable:FREQuency:ENABle?	126
:STATUS:QUESTIONable:FREQuency:NTRansition <integer>	127
:STATUS:QUESTIONable:FREQuency:NTRansition?	127
:STATUS:QUESTIONable:FREQuency:PTRansition <integer>	128

List of Commands

:STATUS:QUESTIONABLE:FREQUENCY:PTRANSITION?	128
:STATUS:QUESTIONABLE:FREQUENCY[:EVENT]?	127
:STATUS:QUESTIONABLE:INTEGRITY:CONDITION?	128
:STATUS:QUESTIONABLE:INTEGRITY:ENABLE <integer>	129
:STATUS:QUESTIONABLE:INTEGRITY:ENABLE?	129
:STATUS:QUESTIONABLE:INTEGRITY:NTRANSITION <integer>	130
:STATUS:QUESTIONABLE:INTEGRITY:NTRANSITION?	130
:STATUS:QUESTIONABLE:INTEGRITY:PTRANSITION <integer>	130
:STATUS:QUESTIONABLE:INTEGRITY:PTRANSITION?	130
:STATUS:QUESTIONABLE:INTEGRITY:SIGNAL:CONDITION?	131
:STATUS:QUESTIONABLE:INTEGRITY:SIGNAL:ENABLE <integer>	131
:STATUS:QUESTIONABLE:INTEGRITY:SIGNAL:ENABLE?	131
:STATUS:QUESTIONABLE:INTEGRITY:SIGNAL:NTRANSITION <integer>	132
:STATUS:QUESTIONABLE:INTEGRITY:SIGNAL:NTRANSITION?	132
:STATUS:QUESTIONABLE:INTEGRITY:SIGNAL:PTRANSITION <integer>	133
:STATUS:QUESTIONABLE:INTEGRITY:SIGNAL:PTRANSITION?	133
:STATUS:QUESTIONABLE:INTEGRITY:SIGNAL[:EVENT]?	132
:STATUS:QUESTIONABLE:INTEGRITY:UNCALIBRATED:CONDITION?	133
:STATUS:QUESTIONABLE:INTEGRITY:UNCALIBRATED:ENABLE?	134
:STATUS:QUESTIONABLE:INTEGRITY:UNCALIBRATED:ENABLE	134
:STATUS:QUESTIONABLE:INTEGRITY:UNCALIBRATED:NTRANSITION <integer>	135
:STATUS:QUESTIONABLE:INTEGRITY:UNCALIBRATED:NTRANSITION?	135
:STATUS:QUESTIONABLE:INTEGRITY:UNCALIBRATED:PTRANSITION <integer>	135
:STATUS:QUESTIONABLE:INTEGRITY:UNCALIBRATED:PTRANSITION?	135
:STATUS:QUESTIONABLE:INTEGRITY:UNCALIBRATED[:EVENT]?	134
:STATUS:QUESTIONABLE:INTEGRITY[:EVENT]?	129
:STATUS:QUESTIONABLE:NTRANSITION 16	115
:STATUS:QUESTIONABLE:NTRANSITION?	115
:STATUS:QUESTIONABLE:POWER:CONDITION?	136
:STATUS:QUESTIONABLE:POWER:ENABLE <integer>	136
:STATUS:QUESTIONABLE:POWER:ENABLE?	136

List of Commands

:STATus:QUEStionable:POWer:NTRansition <integer>	137
:STATus:QUEStionable:POWer:NTRansition?	137
:STATus:QUEStionable:POWer:PTRansition <integer>	138
:STATus:QUEStionable:POWer:PTRansition?>	138
:STATus:QUEStionable:POWer[:EVENT]?	137
:STATus:QUEStionable:PTRansition <integer>	116
:STATus:QUEStionable:PTRansition?	116
:STATus:QUEStionable:TEMPerature:CONDition?	138
:STATus:QUEStionable:TEMPerature:ENABle <integer>	139
:STATus:QUEStionable:TEMPerature:ENABle?	139
:STATus:QUEStionable:TEMPerature:NTRansition <integer>	140
:STATus:QUEStionable:TEMPerature:NTRansition?	140
:STATus:QUEStionable:TEMPerature:PTRansition <integer>	140
:STATus:QUEStionable:TEMPerature:PTRansition?	140
:STATus:QUEStionable:TEMPerature[:EVENT]?	139
:STATus:QUEStionable[:EVENT]?	115
:SYSTem:APPLication:CATalog:OPTion? <model>	556
:SYSTem:APPLication:CATalog:REVision? <model>	555
:SYSTem:APPLication:CATalog[:NAME]:COUNt?	555
:SYSTem:APPLication:CATalog[:NAME]?	555
:SYSTem:APPLication[:CURRent]:OPTion?	554
:SYSTem:APPLication[:CURRent]:REVision?	554
:SYSTem:APPLication[:CURRent][:NAME]?	553
:SYSTem:AUService:DATE?	246
:SYSTem:COMMunicate:GPIB[1][:SELF]:ADDRes <integer>	197
:SYSTem:COMMunicate:GPIB[1][:SELF]:ADDRes?	197
:SYSTem:COMMunicate:GPIB[1][:SELF]:CONTroller[:ENABle] ON OFF 0 1	198
:SYSTem:COMMunicate:GPIB[1][:SELF]:CONTroller[:ENABle]?	198
:SYSTem:COMMunicate:LAN:SCPI:SICL:ENABle OFF ON 0 1	201
:SYSTem:COMMunicate:LAN:SCPI:SICL:ENABle?	201
:SYSTem:COMMunicate:LAN:SCPI:SOCKet:CONTrol?	200

List of Commands

:SYSTem:COMMunicate:LAN:SCPI:SOCKet:ENABle OFF ON 0 1	200
:SYSTem:COMMunicate:LAN:SCPI:SOCKet:ENABle?	200
:SYSTem:COMMunicate:LAN:SCPI:TELNet:ENABle OFF ON 0 1	199
:SYSTem:COMMunicate:LAN:SCPI:TELNet:ENABle?	199
:SYSTem:COMMunicate:USB:CONNectiOn?	202
:SYSTem:COMMunicate:USB:PACKets?	203
:SYSTem:COMMunicate:USB:STATus?	202
:SYSTem:DATE "<year>,<month>,<day>"	251
:SYSTem:DATE?	251
:SYSTem:DEFault [ALL] ALIGn INPut MISC MODes PON	238
:SYSTem:ERRor:VERBose OFF ON 0 1	160
:SYSTem:ERRor:VERBose?	160
:SYSTem:ERRor[:NEXT]?	159
:SYSTem:HELP:HEADers?	251
:SYSTem:HID?	245
:SYSTem:KLOCK OFF ON 0 1	250
:SYSTem:KLOCK?	250
:SYSTem:LKEY "<"OptionInfo">,<"LicenseInfo">	243
:SYSTem:LKEY:DELeTe "<"OptionInfo">,<"LicenseInfo">	243
:SYSTem:LKEY:LIST?	244
:SYSTem:LKEY? "<"OptionInfo">	244
:SYSTem:MRELay:COUNT?	248
:SYSTem:OPTions?	250
:SYSTem:PON:APPLication:LLISt <string of INSTRument:SElect names>	171
:SYSTem:PON:APPLication:LLISt?	171
:SYSTem:PON:APPLication:VMEMory:TOTal?	172
:SYSTem:PON:APPLication:VMEMory:USED:NAME? <INSTRument:SElect name>	172
:SYSTem:PON:APPLication:VMEMory:USED?	172
:SYSTem:PON:APPLication:VMEMory[:AVailab]le?	171
:SYSTem:PON:ETIME?	249
:SYSTem:PON:MODE SA BASIC ADEMOD NFIGURE PNOISE CDMA2K TDSCD-	

List of Commands

MA VSA VSA89601 WCDMA WIMAXOFDMA	168
:SYSTem:PON:MODE?	168
:SYSTem:PON:TIME?	186
:SYSTem:PON:TYPE MODE USER LAST PRESet	167
:SYSTem:PON:TYPE?	167
:SYSTem:PRESet	150
:SYSTem:PRESet:USER	253
:SYSTem:PRESet:USER:ALL	254
:SYSTem:PRESet:USER:SAVE	255
:SYSTem:PRINT:THEMe TDColor TDMonochrome FCOLor FMONochrome	148
:SYSTem:PRINT:THEMe?	148
:SYSTem:PUP:PROcEss	170
:SYSTem:SHOW OFF ERRor SYSTem HARDware LXI HWStatistics ALIGNment SOFTware	158
:SYSTem:SHOW?	158
:SYSTem:TEMPerature:HEXTreme?	248
:SYSTem:TEMPerature:LEXTreme?	248
:SYSTem:TIME "<hour>,<minute>,<second>"	252
:SYSTem:TIME?	252
:SYSTem:VERSion?	251
:TRACe:LPLot:COpy TRACE1 TRACE2 TRACE3,TRACE1 TRACE2 TRACE3	379
:TRACe:LPLot:EXCHange TRACE1 TRACE2 TRACE3,TRACE1 TRACE2 TRACE3	379
:TRACe:MONitor:CLEar [TRACE1] TRACE2 TRACE3	297
:TRACe:MONitor:CLEar:ALL	298
:TRACe[1] 2 3:LPLot:TYPE RAW SMOothed VIEW BLANk	377
:TRACe[1] 2 3:LPLot:TYPE?	377
:TRACe[1] 2 3:MONitor:DISPlay[:STATe] ON OFF 0 1	295
:TRACe[1] 2 3:MONitor:DISPlay[:STATe]?	295
:TRACe[1] 2 3:MONitor:TYPE WRITe AVERAge MAXHold MINHold	294
:TRACe[1] 2 3:MONitor:TYPE?	294
:TRACe[1] 2 3:MONitor:UPDate[:STATe] ON OFF 0 1	295
:TRACe[1] 2 3:MONitor:UPDate[:STATe]?	295

List of Commands

:TRIGger:<measurement>[:SEquence]:IQ:SOURce EXTernal1 EXTernal2 IMMediate IQMag IDEMod QDE-Mod IINPut QINPut AIQMag	646
:TRIGger:<measurement>[:SEquence]:IQ:SOURce?	646
:TRIGger:<measurement>[:SEquence]:RF:SOURce EXTernal1 EXTernal2 IMMediate LINE FRAME RF-Burst VIDeo IF ALARm LAN	645
:TRIGger:<measurement>[:SEquence]:RF:SOURce?	645
:TRIGger:<measurement>[:SEquence]:SOURce EXTernal1 EXTernal2 IMMediate LINE FRAME RFBurst VIDeo IF ALARm LAN IQMag IDEMod QDEMod IINPut QINPut AIQMag	641
:TRIGger:<measurement>[:SEquence]:SOURce?	641
:TRIGger[:SEquence]:AIQMag:BANDwidth <freq>	693
:TRIGger[:SEquence]:AIQMag:BANDwidth?	693
:TRIGger[:SEquence]:AIQMag:CENTer <freq>	692
:TRIGger[:SEquence]:AIQMag:CENTer?	692
:TRIGger[:SEquence]:AIQMag:DELay <time>	692
:TRIGger[:SEquence]:AIQMag:DELay:STATe OFF ON 0 1	692
:TRIGger[:SEquence]:AIQMag:DELay:STATe?	692
:TRIGger[:SEquence]:AIQMag:DELay?	692
:TRIGger[:SEquence]:AIQMag:LEVel <ampl >	691
:TRIGger[:SEquence]:AIQMag:LEVel?	691
:TRIGger[:SEquence]:AIQMag:SLOPe POSitive NEGative	691
:TRIGger[:SEquence]:AIQMag:SLOPe?	691
:TRIGger[:SEquence]:ATRigger <time>	694
:TRIGger[:SEquence]:ATRigger:STATe OFF ON 0 1	694
:TRIGger[:SEquence]:ATRigger:STATe?	694
:TRIGger[:SEquence]:ATRigger?	694
:TRIGger[:SEquence]:EXTernal1:DELay <time>	654
:TRIGger[:SEquence]:EXTernal1:DELay:STATe OFF ON 0 1	654
:TRIGger[:SEquence]:EXTernal1:DELay:STATe?	654
:TRIGger[:SEquence]:EXTernal1:DELay?	654
:TRIGger[:SEquence]:EXTernal1:LEVel <level>	653
:TRIGger[:SEquence]:EXTernal1:LEVel?	653
:TRIGger[:SEquence]:EXTernal1:SLOPe POSitive NEGative	653

List of Commands

:TRIGger[:SEquence]:EXTernal1:SLOPe?	653
:TRIGger[:SEquence]:EXTernal2:DELay <time>	656
:TRIGger[:SEquence]:EXTernal2:DELay:STATe OFF ON 0 1	656
:TRIGger[:SEquence]:EXTernal2:DELay:STATe?	656
:TRIGger[:SEquence]:EXTernal2:DELay?	656
:TRIGger[:SEquence]:EXTernal2:LEVel	655
:TRIGger[:SEquence]:EXTernal2:LEVel?	655
:TRIGger[:SEquence]:EXTernal2:SLOPe POSitive NEGative	655
:TRIGger[:SEquence]:EXTernal2:SLOPe?	655
:TRIGger[:SEquence]:FRAMe:ADJust <time>	662
:TRIGger[:SEquence]:FRAMe:DELay <time>	665
:TRIGger[:SEquence]:FRAMe:DELay:STATe OFF ON 0 1	665
:TRIGger[:SEquence]:FRAMe:DELay:STATe?	665
:TRIGger[:SEquence]:FRAMe:DELay?	665
:TRIGger[:SEquence]:FRAMe:OFFSet <time>	661
:TRIGger[:SEquence]:FRAMe:OFFSet:DISPlay:RESet	663
:TRIGger[:SEquence]:FRAMe:OFFSet?	661
:TRIGger[:SEquence]:FRAMe:PERiod <time>	661
:TRIGger[:SEquence]:FRAMe:PERiod?	661
:TRIGger[:SEquence]:FRAMe:SYNC EXTernal1 EXTernal2 RFBurst OFF	663
:TRIGger[:SEquence]:FRAMe:SYNC:HOLDoff <time>	665
:TRIGger[:SEquence]:FRAMe:SYNC:HOLDoff:STATe OFF ON 0 1	665
:TRIGger[:SEquence]:FRAMe:SYNC:HOLDoff:STATe?	665
:TRIGger[:SEquence]:FRAMe:SYNC:HOLDoff?	665
:TRIGger[:SEquence]:FRAMe:SYNC?	663
:TRIGger[:SEquence]:HOLDoff <time>	694
:TRIGger[:SEquence]:HOLDoff:STATe OFF ON 0 1	694
:TRIGger[:SEquence]:HOLDoff:STATe?	694
:TRIGger[:SEquence]:HOLDoff:TYPE NORMal ABOVe BELow	695
:TRIGger[:SEquence]:HOLDoff:TYPE?	695
:TRIGger[:SEquence]:HOLDoff?	694

List of Commands

:TRIGger[:SEQuence]:IDEMod:DELAy <time>	685
:TRIGger[:SEQuence]:IDEMod:DELAy:STATe OFF ON 0 1	685
:TRIGger[:SEQuence]:IDEMod:DELAy:STATe?	685
:TRIGger[:SEQuence]:IDEMod:DELAy?	685
:TRIGger[:SEQuence]:IDEMod:LEVel <voltage>	685
:TRIGger[:SEQuence]:IDEMod:LEVel?	685
:TRIGger[:SEQuence]:IDEMod:SLOPe POSitive NEGative	685
:TRIGger[:SEQuence]:IDEMod:SLOPe?	685
:TRIGger[:SEQuence]:IINPut:DELAy <time>	688
:TRIGger[:SEQuence]:IINPut:DELAy:STATe OFF ON 0 1	688
:TRIGger[:SEQuence]:IINPut:DELAy:STATe?	688
:TRIGger[:SEQuence]:IINPut:DELAy?	688
:TRIGger[:SEQuence]:IINPut:LEVel <voltage>	688
:TRIGger[:SEQuence]:IINPut:LEVel?	688
:TRIGger[:SEQuence]:IINPut:SLOPe POSitive NEGative	688
:TRIGger[:SEQuence]:IINPut:SLOPe?	688
:TRIGger[:SEQuence]:IQMag:DELAy <time>	684
:TRIGger[:SEQuence]:IQMag:DELAy:STATe OFF ON 0 1	684
:TRIGger[:SEQuence]:IQMag:DELAy:STATe?	684
:TRIGger[:SEQuence]:IQMag:DELAy?	684
:TRIGger[:SEQuence]:IQMag:LEVel <ampl >	683
:TRIGger[:SEQuence]:IQMag:LEVel?	683
:TRIGger[:SEQuence]:IQMag:SLOPe POSitive NEGative	684
:TRIGger[:SEQuence]:IQMag:SLOPe?	684
:TRIGger[:SEQuence]:LINE:DELAy <time>	652
:TRIGger[:SEQuence]:LINE:DELAy:STATe OFF ON 0 1	652
:TRIGger[:SEQuence]:LINE:DELAy:STATe?	652
:TRIGger[:SEQuence]:LINE:DELAy?	652
:TRIGger[:SEQuence]:LINE:SLOPe POSitive NEGative	652
:TRIGger[:SEQuence]:LINE:SLOPe?	652
:TRIGger[:SEQuence]:LXI:ALARm:DISable:ALL	673

List of Commands

:TRIGger[:SEQuence]:LXI:ALARm:LIST?	674
:TRIGger[:SEQuence]:LXI:ALARm[:SET]:CONFigure "alarmEvent", <enable>, <epochSeconds>, <epochFraction>, <period>, <repeat>	682
:TRIGger[:SEQuence]:LXI:ALARm[:SET]:ENABled "alarmEvent",ON OFF 1 0	681
:TRIGger[:SEQuence]:LXI:ALARm[:SET]:ENABled? "alarmEvent"	682
:TRIGger[:SEQuence]:LXI:ALARm[:SET]:PERiod "alarmEvent",<seconds>	680
:TRIGger[:SEQuence]:LXI:ALARm[:SET]:PERiod? "alarmEvent"	680
:TRIGger[:SEQuence]:LXI:ALARm[:SET]:REPeat "alarmEvent",<repetitions>	681
:TRIGger[:SEQuence]:LXI:ALARm[:SET]:REPeat? "alarmEvent"	681
:TRIGger[:SEQuence]:LXI:ALARm[:SET]:TIME:SEConds "alarmEvent",<seconds>	678
:TRIGger[:SEQuence]:LXI:ALARm[:SET]:TIME:SEConds? "alarmEvent"	678
:TRIGger[:SEQuence]:LXI:ALARm[:SET]:TIME[:VALue] "alarmEvent",<seconds>, <fractionalSeconds>	677
:TRIGger[:SEQuence]:LXI:ALARm[:SET]:TIME[:VALue]:ABSolute "alarmEvent","date","time"	674
:TRIGger[:SEQuence]:LXI:ALARm[:SET]:TIME[:VALue]:ABSolute? "alarmEvent"	675
:TRIGger[:SEQuence]:LXI:ALARm[:SET]:TIME[:VALue]:FRACTION "alarmEvent",<fractionalSeconds>	679
:TRIGger[:SEQuence]:LXI:ALARm[:SET]:TIME[:VALue]:FRACTION? "alarmEvent"	679
:TRIGger[:SEQuence]:LXI:ALARm[:SET]:TIME[:VALue]:RELative "alarmEvent",<seconds>	679
:TRIGger[:SEQuence]:LXI:ALARm[:SET]:TIME[:VALue]:RELative? "alarmEvent"	680
:TRIGger[:SEQuence]:LXI:ALARm[:SET]:TIME[:VALue]?	677
:TRIGger[:SEQuence]:LXI:LAN:ADD "LANEVENT"	670
:TRIGger[:SEQuence]:LXI:LAN:COUNT?	672
:TRIGger[:SEQuence]:LXI:LAN:DISable:ALL	667
:TRIGger[:SEQuence]:LXI:LAN:LIST?	667
:TRIGger[:SEQuence]:LXI:LAN:REMOve:ALL	671
:TRIGger[:SEQuence]:LXI:LAN:REMOve[:EVENT] "LANEVENT"	670
:TRIGger[:SEQuence]:LXI:LAN[:SET]:CONFigure "lanEvent", <enable>, <detection>, <delay>, <filter>, <identifier>	673
:TRIGger[:SEQuence]:LXI:LAN[:SET]:DELay "LANEVENT",<time>	668
:TRIGger[:SEQuence]:LXI:LAN[:SET]:DELay? "lanEvent"	669
:TRIGger[:SEQuence]:LXI:LAN[:SET]:DETection "LANEVENT", HIGH LOW RISE FALL	668
:TRIGger[:SEQuence]:LXI:LAN[:SET]:DETection? "LANEVENT"	668
:TRIGger[:SEQuence]:LXI:LAN[:SET]:ENABled "LANEVENT",ON OFF 1 0	669

List of Commands

:TRIGger[:SEQuence]:LXI:LAN[:SET]:ENABled? "LANEVENT"	669
:TRIGger[:SEQuence]:LXI:LAN[:SET]:FILTer "LANEVENT","filterString"	671
:TRIGger[:SEQuence]:LXI:LAN[:SET]:FILTer?	671
:TRIGger[:SEQuence]:LXI:LAN[:SET]:IDENtifier "LANEVENT","identifier"	672
:TRIGger[:SEQuence]:LXI:LAN[:SET]:IDENtifier? "LANEVENT"	672
:TRIGger[:SEQuence]:OFFSet <time>	696
:TRIGger[:SEQuence]:OFFSet:STATe OFF ON 0 1	696
:TRIGger[:SEQuence]:OFFSet:STATe?	696
:TRIGger[:SEQuence]:OFFSet?	696
:TRIGger[:SEQuence]:QDEMod:DELay <time>	687
:TRIGger[:SEQuence]:QDEMod:DELay:STATe OFF ON 0 1	687
:TRIGger[:SEQuence]:QDEMod:DELay:STATe?	687
:TRIGger[:SEQuence]:QDEMod:DELay?	687
:TRIGger[:SEQuence]:QDEMod:LEVel <voltage>	686
:TRIGger[:SEQuence]:QDEMod:LEVel?	686
:TRIGger[:SEQuence]:QDEMod:SLOPe POSitive NEGative	687
:TRIGger[:SEQuence]:QDEMod:SLOPe?	687
:TRIGger[:SEQuence]:QINPut:DELay <time>	690
:TRIGger[:SEQuence]:QINPut:DELay:STATe OFF ON 0 1	690
:TRIGger[:SEQuence]:QINPut:DELay:STATe?	690
:TRIGger[:SEQuence]:QINPut:DELay?	690
:TRIGger[:SEQuence]:QINPut:LEVel <voltage>	689
:TRIGger[:SEQuence]:QINPut:LEVel?	689
:TRIGger[:SEQuence]:QINPut:SLOPe POSitive NEGative	690
:TRIGger[:SEQuence]:QINPut:SLOPe?	690
:TRIGger[:SEQuence]:RFBurst:DELay <time>	659
:TRIGger[:SEQuence]:RFBurst:DELay:STATe OFF ON 0 1	659
:TRIGger[:SEQuence]:RFBurst:DELay:STATe?	659
:TRIGger[:SEQuence]:RFBurst:DELay?	659
:TRIGger[:SEQuence]:RFBurst:LEVel:ABSolute <ampl>	657
:TRIGger[:SEQuence]:RFBurst:LEVel:ABSolute?	657

List of Commands

:TRIGger[:SEQuence]:RFBurst:LEVel:RELative <ampl>	657
:TRIGger[:SEQuence]:RFBurst:LEVel:RELative?	657
:TRIGger[:SEQuence]:RFBurst:LEVel:TYPE ABSolute RELative	657
:TRIGger[:SEQuence]:RFBurst:LEVel:TYPE?	657
:TRIGger[:SEQuence]:RFBurst:SLOPe POSitive NEGative	658
:TRIGger[:SEQuence]:RFBurst:SLOPe?	658
:TRIGger[:SEQuence]:VIDeo:DELay <time>	651
:TRIGger[:SEQuence]:VIDeo:DELay:STATe OFF ON 0 1	651
:TRIGger[:SEQuence]:VIDeo:DELay:STATe?	651
:TRIGger[:SEQuence]:VIDeo:DELay?	651
:TRIGger[:SEQuence]:VIDeo:LEVel <ampl>	650
:TRIGger[:SEQuence]:VIDeo:LEVel?	650
:TRIGger[:SEQuence]:VIDeo:SLOPe POSitive NEGative	650
:TRIGger[:SEQuence]:VIDeo:SLOPe?	650
:TRIGger TRIGger1 TRIGger2[:SEQuence]:OUTPut HSWP MEASuring MAIN GATE GTRigger OEVen.	512
:TRIGger TRIGger1 TRIGger2[:SEQuence]:OUTPut:POLarity POSitive NEGative	512
:TRIGger TRIGger1 TRIGger2[:SEQuence]:OUTPut:POLarity?	512
:TRIGger TRIGger1 TRIGger2[:SEQuence]:OUTPut?	512
:TRIGger1 TRIGger[:SEQuence]:LXI:ALARm:COUNT?	682
[:SENSe]:CORRection:BTS[:RF]:GAIN <rel_ampl>	492
[:SENSe]:CORRection:BTS[:RF]:GAIN?	492
[:SENSe]:CORRection:CSET:ALL:DELeTe	506
[:SENSe]:CORRection:CSET:ALL[:STATe] ON OFF 1 0	506
[:SENSe]:CORRection:CSET:ALL[:STATe]?	506
[:SENSe]:CORRection:CSET[1] 2 3 4:ANTenna[:UNIT] GAUSs PTESla UVM UAM NOConversion	500
[:SENSe]:CORRection:CSET[1] 2 3 4:ANTenna[:UNIT]?	500
[:SENSe]:CORRection:CSET[1] 2 3 4:COMMeNt "text"	503
[:SENSe]:CORRection:CSET[1] 2 3 4:COMMeNt?	503
[:SENSe]:CORRection:CSET[1] 2 3 4:DATA <freq>, <ampl>,	506
[:SENSe]:CORRection:CSET[1] 2 3 4:DATA:MERGe <freq>, <ampl>,.....	507
[:SENSe]:CORRection:CSET[1] 2 3 4:DATA?	506

List of Commands

[[:SENSe]:CORRection:CSET[1] 2 3 4:DELeTe	505
[[:SENSe]:CORRection:CSET[1] 2 3 4:DESCription "text"	502
[[:SENSe]:CORRection:CSET[1] 2 3 4:DESCription?	502
[[:SENSe]:CORRection:CSET[1] 2 3 4:X:SPACing LINear LOGarithmic	502
[[:SENSe]:CORRection:CSET[1] 2 3 4:X:SPACing?	502
[[:SENSe]:CORRection:CSET[1] 2 3 4[:STATe] ON OFF 1 0	499
[[:SENSe]:CORRection:CSET[1] 2 3 4[:STATe]?	499
[[:SENSe]:CORRection:IMPedance[:INPut][:MAGNitude] 50 75	472
[[:SENSe]:CORRection:IMPedance[:INPut][:MAGNitude]?	472
[[:SENSe]:CORRection:IQ:I:GAIN <rel_ampl>	492
[[:SENSe]:CORRection:IQ:I:GAIN?	492
[[:SENSe]:CORRection:IQ:I Q:ATTenuation <rel_ampl>	485
[[:SENSe]:CORRection:IQ:I Q:ATTenuation:RATio <real>	484
[[:SENSe]:CORRection:IQ:I Q:ATTenuation:RATio?	484
[[:SENSe]:CORRection:IQ:I Q:ATTenuation?	485
[[:SENSe]:CORRection:IQ:Q:GAIN <rel_ampl>	493
[[:SENSe]:CORRection:IQ:Q:GAIN?	493
[[:SENSe]:CORRection:IQ:Q:SKEW <seconds>	483
[[:SENSe]:CORRection:IQ:Q:SKEW?	483
[[:SENSe]:CORRection:IQ[I]:SKEW <seconds>	479
[[:SENSe]:CORRection:IQ[I]:SKEW?	479
[[:SENSe]:CORRection:MS[:RF]:GAIN <rel_ampl>	491
[[:SENSe]:CORRection:MS[:RF]:GAIN?	491
[[:SENSe]:CORRection:SA[:RF]:GAIN <rel_ampl>	491
[[:SENSe]:CORRection:SA[:RF]:GAIN?	491
[[:SENSe]:FEED RF AIQ IQ IONLy QONLy AREFerence	471
[[:SENSe]:FEED:AREFerence REF50 REF4800 COMB OFF	488
[[:SENSe]:FEED:AREFerence?	488
[[:SENSe]:FEED:DATA INPut STORed RECOred	494
[[:SENSe]:FEED:DATA:STORe	496
[[:SENSe]:FEED:DATA?	494

List of Commands

[[:SENSe]:FEED:IQ:TYPE IQ IONLy QONLy	476
[[:SENSe]:FEED:IQ:TYPE?	476
[[:SENSe]:FEED?	471
[[:SENSe]:FREQuency:CARRier <freq>	467
[[:SENSe]:FREQuency:CARRier:SEARch.....	467
[[:SENSe]:FREQuency:CARRier:TRACk:ACCuracy LOW MED HIGH.....	470
[[:SENSe]:FREQuency:CARRier:TRACk:ACCuracy?	470
[[:SENSe]:FREQuency:CARRier:TRACk:SPAN <freq>.....	469
[[:SENSe]:FREQuency:CARRier:TRACk:SPAN:AUTO ON OFF 1 0	469
[[:SENSe]:FREQuency:CARRier:TRACk:SPAN:AUTO?.....	469
[[:SENSe]:FREQuency:CARRier:TRACk:SPAN?.....	469
[[:SENSe]:FREQuency:CARRier:TRACk[:STATe] OFF ON 0 1	468
[[:SENSe]:FREQuency:CARRier:TRACk[:STATe]?	468
[[:SENSe]:FREQuency:CARRier?	467
[[:SENSe]:LPLot:AMRejection ON OFF 1 0	364
[[:SENSe]:LPLot:AMRejection?.....	364
[[:SENSe]:LPLot:AVERAge:COUNT <integer>	360
[[:SENSe]:LPLot:AVERAge:COUNT?.....	360
[[:SENSe]:LPLot:AVERAge:TCONtrol EXPonential REPeat.....	361
[[:SENSe]:LPLot:AVERAge:TCONtrol?.....	361
[[:SENSe]:LPLot:AVERAge[:STATe] OFF ON 0 1	360
[[:SENSe]:LPLot:AVERAge[:STATe]?	360
[[:SENSe]:LPLot:CANCellation:DELTA <rel_amp>.....	364
[[:SENSe]:LPLot:CANCellation:DELTA?.....	364
[[:SENSe]:LPLot:CANCellation:TRACe <integer>.....	363
[[:SENSe]:LPLot:CANCellation:TRACe?	363
[[:SENSe]:LPLot:CANCellation[:STATe] OFF ON 0 1	363
[[:SENSe]:LPLot:CANCellation[:STATe]?.....	363
[[:SENSe]:LPLot:DETEctor[:FUNction]?	377
[[:SENSe]:LPLot:FREQuency:OFFSet:STARt <freq>.....	374
[[:SENSe]:LPLot:FREQuency:OFFSet:STARt?.....	374

List of Commands

[:SENSe]:LPLot:FREQuency:OFFSet:STOP <freq>	375
[:SENSe]:LPLot:FREQuency:OFFSet:STOP?	375
[:SENSe]:LPLot:METhod DANL PN	361
[:SENSe]:LPLot:METhod?	361
[:SENSe]:LPLot:ODRive ON OFF 1 0	365
[:SENSe]:LPLot:ODRive?	365
[:SENSe]:LPLot:SMOoth <real>	362
[:SENSe]:LPLot:SMOoth?	362
[:SENSe]:MONitor:AVERage:COUNT <integer>	280
[:SENSe]:MONitor:AVERage:COUNT?	280
[:SENSe]:MONitor:AVERage:TCONtrol EXPonential REPeat	281
[:SENSe]:MONitor:AVERage:TCONtrol?	281
[:SENSe]:MONitor:AVERage[:STATe] OFF ON 0 1	280
[:SENSe]:MONitor:AVERage[:STATe]?	280
[:SENSe]:MONitor:BANDwidth:VIDeo <bandwidth>	264
[:SENSe]:MONitor:BANDwidth:VIDeo:AUTO ON OFF 1 0	264
[:SENSe]:MONitor:BANDwidth:VIDeo:AUTO?	264
[:SENSe]:MONitor:BANDwidth:VIDeo:RATio <real>	265
[:SENSe]:MONitor:BANDwidth:VIDeo:RATio:AUTO OFF ON 0 1	265
[:SENSe]:MONitor:BANDwidth:VIDeo:RATio:AUTO?	265
[:SENSe]:MONitor:BANDwidth:VIDeo:RATio?	265
[:SENSe]:MONitor:BANDwidth:VIDeo?	264
[:SENSe]:MONitor:BANDwidth[:RESolution] <freq>	263
[:SENSe]:MONitor:BANDwidth[:RESolution]:AUTO OFF ON 0 1	263
[:SENSe]:MONitor:BANDwidth[:RESolution]:AUTO?	263
[:SENSe]:MONitor:BANDwidth[:RESolution]?	263
[:SENSe]:MONitor:DETEctor:AUTO ON OFF 1 0	297
[:SENSe]:MONitor:DETEctor:AUTO?	297
[:SENSe]:MONitor:DETEctor:TRACe AVERage NEGative NORMal POSitive SAMPle	296
[:SENSe]:MONitor:DETEctor:TRACe?	296
[:SENSe]:MONitor:FREQuency:SPAN <freq>	290

List of Commands

[[:SENSe]:MONitor:FREQuency:SPAN:BANDwidth[:RESolution]:RATio <integer>	265
[[:SENSe]:MONitor:FREQuency:SPAN:BANDwidth[:RESolution]:RATio:AUTO OFF ON 0 1	265
[[:SENSe]:MONitor:FREQuency:SPAN:BANDwidth[:RESolution]:RATio:AUTO?	265
[[:SENSe]:MONitor:FREQuency:SPAN:BANDwidth[:RESolution]:RATio?	265
[[:SENSe]:MONitor:FREQuency:SPAN:FULL	291
[[:SENSe]:MONitor:FREQuency:SPAN:PREVious	291
[[:SENSe]:MONitor:FREQuency:SPAN?	290
[[:SENSe]:MONitor:SWEEP:POINTS <integer>	293
[[:SENSe]:MONitor:SWEEP:POINTS?	293
[[:SENSe]:MONitor:SWEEP:TIME <time>	292
[[:SENSe]:MONitor:SWEEP:TIME:AUTO OFF ON 0 1	292
[[:SENSe]:MONitor:SWEEP:TIME:AUTO?	292
[[:SENSe]:MONitor:SWEEP:TIME?	292
[[:SENSe]:POWER:IQ:Q:RANGE[:UPPer] <ampl>	454
[[:SENSe]:POWER:IQ:Q:RANGE[:UPPer]?	454
[[:SENSe]:POWER:IQ:RANGE:AUTO OFF ON 0 1	451
[[:SENSe]:POWER:IQ:RANGE:AUTO?	451
[[:SENSe]:POWER:IQ[:I]:RANGE[:UPPer] <ampl>	452
[[:SENSe]:POWER:IQ[:I]:RANGE[:UPPer]?	452
[[:SENSe]:POWER[:RF]:ATTenuation <rel_ampl>	443
[[:SENSe]:POWER[:RF]:ATTenuation:AUTO OFF ON 0 1	443
[[:SENSe]:POWER[:RF]:ATTenuation:AUTO?	443
[[:SENSe]:POWER[:RF]:ATTenuation:STEP[:INCRement] 10 dB 2 dB	448
[[:SENSe]:POWER[:RF]:ATTenuation:STEP[:INCRement]?	448
[[:SENSe]:POWER[:RF]:ATTenuation?	443
[[:SENSe]:POWER[:RF]:EATTenuation <rel_ampl>	446
[[:SENSe]:POWER[:RF]:EATTenuation:STATe OFF ON 0 1	445
[[:SENSe]:POWER[:RF]:EATTenuation:STATe?	445
[[:SENSe]:POWER[:RF]:EATTenuation?	446
[[:SENSe]:POWER[:RF]:GAIN:BAND LOW FULL	458
[[:SENSe]:POWER[:RF]:GAIN:BAND?	458

List of Commands

[[:SENSe]:POWer[:RF]:GAIN[:STATe] OFF ON 0 1	458
[[:SENSe]:POWer[:RF]:GAIN[:STATe]?	458
[[:SENSe]:POWer[:RF]:MIXer:RANGe[:UPPer] <real>	449
[[:SENSe]:POWer[:RF]:MIXer:RANGe[:UPPer]?	449
[[:SENSe]:POWer[:RF]:PADJust <freq>	457
[[:SENSe]:POWer[:RF]:PADJust:PRESelector MWAVe MMWave EXTernal	457
[[:SENSe]:POWer[:RF]:PADJust:PRESelector?	457
[[:SENSe]:POWer[:RF]:PADJust?	457
[[:SENSe]:POWer[:RF]:PCENter	456
[[:SENSe]:POWer[:RF]:RANGe:AUTO ON OFF 1 0	448
[[:SENSe]:POWer[:RF]:RANGe:AUTO?	448
[[:SENSe]:POWer[:RF]:RANGe:OPTimize IMMEDIATE	446
[[:SENSe]:POWer[:RF]:RANGe:OPTimize:ATTenuation OFF ELEctrical COMBined	447
[[:SENSe]:POWer[:RF]:RANGe:OPTimize:ATTenuation?	447
[[:SENSe]:RECOding:ABORt	496
[[:SENSe]:RECOding:INITiate[:IMMEDIATE].	496
[[:SENSe]:RECOding:LENGth <real>,SECOnds RECOds POINts	497
[[:SENSe]:RECOding:LENGth:STATe MAX MANual	497
[[:SENSe]:RECOding:LENGth:STATe?	497
[[:SENSe]:RECOding:LENGth:UNIT?	498
[[:SENSe]:RECOding:LENGth:VALue?	497
[[:SENSe]:ROSCillator:COUPling NORMal NACQuisition	511
[[:SENSe]:ROSCillator:COUPling?	511
[[:SENSe]:ROSCillator:EXTernal:FREQuency <freq>	510
[[:SENSe]:ROSCillator:EXTernal:FREQuency?	510
[[:SENSe]:ROSCillator:SOURce INTernal EXTernal	509
[[:SENSe]:ROSCillator:SOURce:TYPE INTernal EXTernal SENSe	508
[[:SENSe]:ROSCillator:SOURce:TYPE?	508
[[:SENSe]:ROSCillator:SOURce?	508
[[:SENSe]:SFRequency:AVERage:COUNt <integer>	317
[[:SENSe]:SFRequency:AVERage:COUNt?	317

List of Commands

[[:SENSe]:SFRequency:AVERage:TCONtrol EXPonential REPeat	318
[[:SENSe]:SFRequency:AVERage:TCONtrol?	318
[[:SENSe]:SFRequency:AVERage[:STATe] OFF ON 0 1	317
[[:SENSe]:SFRequency:AVERage[:STATe]?	317
[[:SENSe]:SFRequency:BANDwidth:VIDeo:AUTO?	308
[[:SENSe]:SFRequency:BANDwidth:VIDeo:RATio <real>	309
[[:SENSe]:SFRequency:BANDwidth:VIDeo:RATio:AUTO ON OFF 1 0	309
[[:SENSe]:SFRequency:BANDwidth:VIDeo:RATio:AUTO?	309
[[:SENSe]:SFRequency:BANDwidth:VIDeo:RATio?	309
[[:SENSe]:SFRequency:BANDwidth:VIDeo?	308
[[:SENSe]:SFRequency:BANDwidth[:RESolution]:AUTO?	308
[[:SENSe]:SFRequency:BANDwidth[:RESolution]?	308
[[:SENSe]:SFRequency:DETEctor[:FUNCTion]?	331
[[:SENSe]:SFRequency:METHod DANL PN	318
[[:SENSe]:SFRequency:METHod?	318
[[:SENSe]:SFRequency:SOFFset <freq>	319
[[:SENSe]:SFRequency:SOFFset:BANDwidth[:RESolution]:RATio <real>	320
[[:SENSe]:SFRequency:SOFFset:BANDwidth[:RESolution]:RATio?	320
[[:SENSe]:SFRequency:SOFFset?	319
[[:SENSe]:SFRequency:SWEep:TIME <time>	330
[[:SENSe]:SFRequency:SWEep:TIME:AUTO ON OFF 1 0	330
[[:SENSe]:SFRequency:SWEep:TIME:AUTO?	330
[[:SENSe]:SFRequency:SWEep:TIME?	330
[[:SENSe]:SWEep:EGATe:CONTRol EDGE LEVEL	635
[[:SENSe]:SWEep:EGATe:CONTRol?	635
[[:SENSe]:SWEep:EGATe:DELay <time>	631
[[:SENSe]:SWEep:EGATe:DELay:COMPensation:TYPE OFF SETTled GDELay	637
[[:SENSe]:SWEep:EGATe:DELay:COMPensation:TYPE?	637
[[:SENSe]:SWEep:EGATe:DELay?	631
[[:SENSe]:SWEep:EGATe:HOLDoff <time>	636
[[:SENSe]:SWEep:EGATe:HOLDoff:AUTO OFF ON 0 1	636

List of Commands

[:SENSe]:SWEep:EGATe:HOLDOff:AUTO?	636
[:SENSe]:SWEep:EGATe:HOLDOff?	636
[:SENSe]:SWEep:EGATe:LENGth <time>	632
[:SENSe]:SWEep:EGATe:LENGth?	632
[:SENSe]:SWEep:EGATe:METHod LO VIDeo FFT	632
[:SENSe]:SWEep:EGATe:METHod?	632
[:SENSe]:SWEep:EGATe:MINFast?	638
[:SENSe]:SWEep:EGATe:SOURce EXTernal1 EXTernal2 LINE FRAME RFBurst TV	634
[:SENSe]:SWEep:EGATe:SOURce?	634
[:SENSe]:SWEep:EGATe:TIME <time>	630
[:SENSe]:SWEep:EGATe:TIME?	630
[:SENSe]:SWEep:EGATe:VIEW ON OFF 1 0	628
[:SENSe]:SWEep:EGATe:VIEW?	628
[:SENSe]:SWEep:EGATe[:STATe] OFF ON 0 1	627
[:SENSe]:SWEep:EGATe[:STATe]?	627
[:SENSe]:VOLTage:IQ:Q:RANGe[:UPPer] <voltage>	453
[:SENSe]:VOLTage:IQ:Q:RANGe[:UPPer]?	453
[:SENSe]:VOLTage:IQ:RANGe:AUTO OFF ON 0 1	450
[:SENSe]:VOLTage:IQ:RANGe:AUTO?	450
[:SENSe]:VOLTage:IQ[:I]:RANGe[:UPPer] <voltage>	451
[:SENSe]:VOLTage:IQ[:I]:RANGe[:UPPer]?	451
[:SENSe]:VOLTage POWER:IQ:MIRROred OFF ON 0 1	453
[:SENSe]:VOLTage POWER:IQ:MIRROred?	453
[:SENSe]:WAVEform:ADC:DITHer:AUTO[:STATe] OFF ON 0 1	420
[:SENSe]:WAVEform:ADC:DITHer:AUTO[:STATe]?	420
[:SENSe]:WAVEform:ADC:DITHer[:STATe] OFF ON 0 1	421
[:SENSe]:WAVEform:ADC:DITHer[:STATe]?	421
[:SENSe]:WAVEform:AVERage:COUNt <integer>	417
[:SENSe]:WAVEform:AVERage:COUNt?	417
[:SENSe]:WAVEform:AVERage:TCONtrol EXPonential REPeat.	418
[:SENSe]:WAVEform:AVERage:TCONtrol?	418

List of Commands

[[:SENSe]:WAVeform:AVERage:TYPE LOG MAXimum MINimum RMS SCALar	418
[[:SENSe]:WAVeform:AVERage:TYPE?	418
[[:SENSe]:WAVeform:AVERage[:STATe] OFF ON 0 1	417
[[:SENSe]:WAVeform:AVERage[:STATe]?	417
[[:SENSe]:WAVeform:BANDwidth:SHAPE GAUSSian FLATtop	394
[[:SENSe]:WAVeform:BANDwidth:SHAPE?	394
[[:SENSe]:WAVeform:BANDwidth[:RESolution] <freq>	393
[[:SENSe]:WAVeform:BANDwidth[:RESolution]?	393
[[:SENSe]:WAVeform:IF:GAIN:AUTO[:STATe] ON OFF 1 0	422
[[:SENSe]:WAVeform:IF:GAIN:AUTO[:STATe]?	422
[[:SENSe]:WAVeform:IF:GAIN[:STATe] AUTOrange LOW HIGH	422
[[:SENSe]:WAVeform:IF:GAIN[:STATe]?	422
[[:SENSe]:WAVeform:SWEEP:TIME <time>	419
[[:SENSe]:WAVeform:SWEEP:TIME?	419

Welcome to the X-Series Signal Analyzer Help system!

The online Help system is "context-sensitive". This means that the information displayed when you invoke the Help system depends on the selected Analyzer Mode, Measurement and key.

TIP

To view help for any Front-panel key or menu key, press that key with this Help Window open.

To scroll any page vertically (to see the whole of a long topic), press the **Down Arrow** key on the Front Panel to scroll down (or the **Up Arrow** key to scroll up). To locate these keys, see [“Front Panel Keys used by the Help System” on page 59](#).

See [“Navigating the Help Window Without a Mouse” on page 64](#) for complete information about **Using Help without an attached Mouse and Keyboard**. For specific details of how to navigate to topics, see [“Finding a Topic without a Mouse and Keyboard” on page 73](#).

See [“Navigating the Help Window with a Mouse” on page 62](#) to learn about **Using Help with an attached Mouse and Keyboard**.

You can view Help on the Analyzer itself, or you can **View Help on Another Computer**, by copying the Help files and viewing Help there. For details, see the Section [“Viewing Help on a separate Computer” on page 53](#).

To locate **Other Available Help Resources**, see [“Locating Other Help Resources” on page 52](#).

Key Path

Help

Locating Other Help Resources

All available documentation is present on the Analyzer's hard disk, either as HTML Help or Acrobat PDF files.

In addition to the interactive Windows (HTML) Help system, the Analyzer's hard disk contains Application Notes, tutorial documents, etc.

This same documentation is also included on the Documentation CD shipped with your Analyzer.

Many of the supporting documents use the Adobe Acrobat (PDF) file format. You can view PDF files using the pre-installed Adobe Reader software.

The Adobe Reader user interface differs from the Windows Help interface. For full details on how to navigate within Acrobat documents using Adobe Reader, see [“Navigating Acrobat \(PDF\) Files”](#) on page 68.

Viewing Help on a separate Computer

You may want to view the help pages *without* having them appear on top of the Analyzer's screen.

There are two separate Help files for each Analyzer Mode, which contain all the same help pages in different formats:

1. A file in HTML Help (CHM) format,
2. A file in Acrobat (PDF) format.

You can copy any of the Help files to another computer, then open and view the help pages in the file on that computer.

Your choice of which file to copy and view may depend on what you want to do with the file (for example, whether you want to print it and read the paper copy, or view it on the computer). The table below compares the relative advantages of the two formats:

Format Type	HTML Help Format (CHM Files)	Acrobat Format (PDF Files)
File Extension	CHM	PDF
Software Required to view file	Microsoft Windows operating system only, with Microsoft Internet Explorer installed.	Free Adobe Reader software can be downloaded for many operating systems, including: Microsoft Windows, Macintosh, Linux, Solaris.
Full Text Search?	Yes	Yes
Printable?	Yes, but with limited control.	Yes. Full print control.
Printable Table of Contents?	No	Yes
Navigable without a Mouse and Keyboard?	Yes, but with some loss of functionality.	No
Has Page Numbers?	No	Yes
Context-Sensitive Display?	Yes, when viewed using the X-Series Analyzer application window.	No
Indexed?	Yes	No
Active Hyperlinks?	Yes	Yes

Copying the HTML Help (CHM) Files

You can copy the HTML Help file(s) you need to a separate computer running Microsoft Windows. Each HTML Help file has a .chm extension.

You can find the HTML Help (.chm) files:

- *Either*, on the documentation CD that came with the Analyzer,

Using Help

Viewing Help on a separate Computer

- *Or*, in a special directory on the Analyzer's hard disk. The directory path is:
C:\Program Files\Agilent\SignalAnalysis\Infrastructure\Help
The illustration below shows an example listing of the HTML Help files in this directory, viewed using Windows Explorer.
Depending on which Analyzer software licenses you purchased, the content of the directory on your machine may vary.

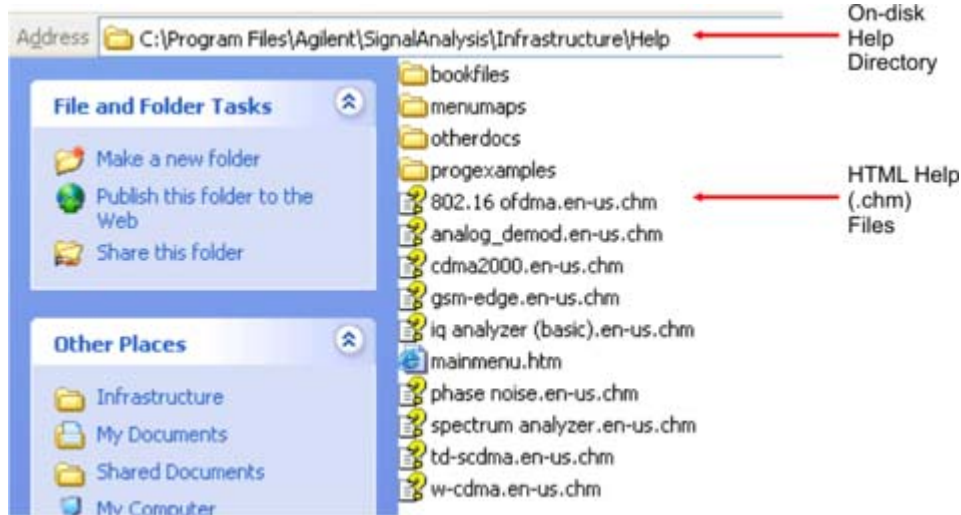

NOTE You can open and view the HTML Help files only on a PC that has Microsoft Windows and Microsoft Internet Explorer installed.

Copying the Acrobat (PDF) Files

You can copy the Acrobat file(s) you need to a separate computer running any of several different operating systems. Each Acrobat file has a `.pdf` extension.

You can find the Acrobat (`.pdf`) files:

- *Either*, on the documentation CD that came with the Analyzer,
- *Or*, in a special directory on the Analyzer's hard disk. The directory path is:
C:\Program Files\Agilent\SignalAnalysis\Infrastructure\Help\bookfiles
 - The illustration below shows an example listing of the Acrobat files in this directory, viewed using Windows Explorer.
 - The PDF versions of the help files are named `<mode>_ref.pdf`, where `<mode>` is the name of the Analyzer Mode. For example, the name of the PDF file for GSM/EDGE Mode is `gsmedge_ref.pdf`. (Note that the directory also contains other PDF documents.)
 - When you open any `<mode>_ref.pdf` document, the title page displays "`<Mode> User's and Programmer's Reference`", where `<Mode>` is the name of the Analyzer Mode described by the document.
 - Depending on which Analyzer software licenses you purchased, the content of the directory on your machine may vary.

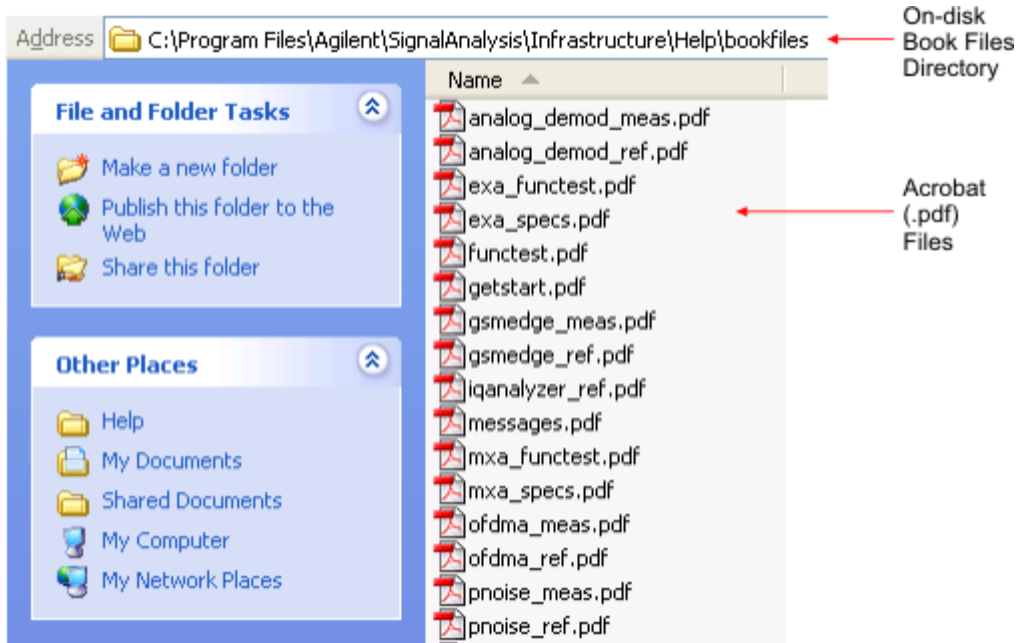

How Help is Organized

This topic contains the following sections:

“Help Contents Listing” on page 56

“System Functions” on page 56

“Key Descriptions for Each Measurement” on page 57

“Key Information for Softkeys” on page 57

“Common Measurement Functions” on page 58

Help Contents Listing

The listing under the Contents tab in the Help Window includes a topic for each Front-panel key and each softkey, for each available measurement.

The Contents listing is split into several major sections, as shown below for the HTML Help version of the document. The structure of the PDF version is similar.

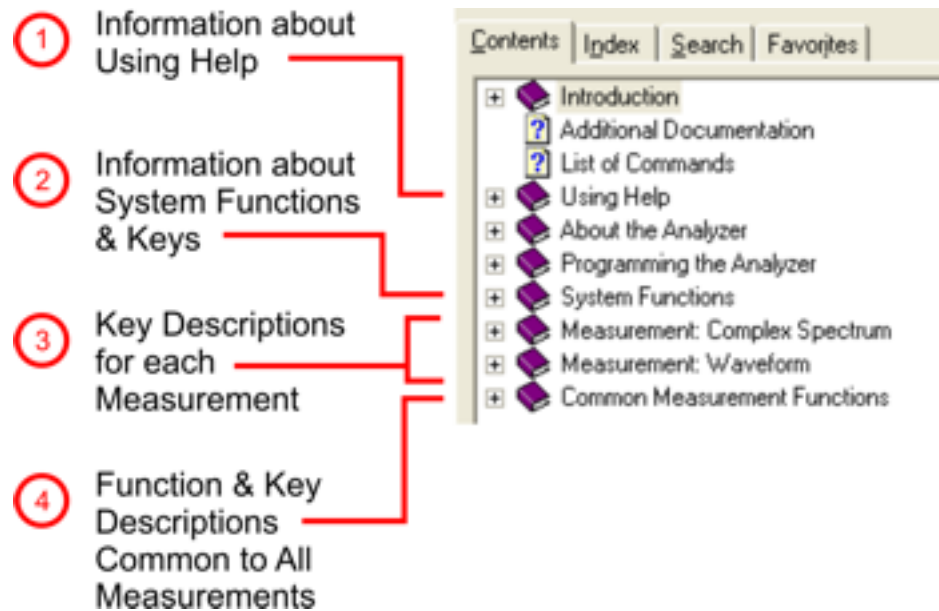

Help information is split between these sections as follows:

1. Using Help: this section.
2. System Functions. See “System Functions” on page 56 below.
3. Measurement Functions. See “Key Descriptions for Each Measurement” on page 57 below.
4. Common Measurement Functions. See “Common Measurement Functions” on page 58 below.

System Functions

This section contains information for the following keys, which are listed in alphabetical order: **File**,

Preset, Print, Quick Save, Recall, Save, System, User Preset.

The functions of these keys do not vary between measurements: they operate the same way, irrespective of which Analyzer measurement you have selected.

The sections for **Recall** and **Save** contain only cross-references to the respective sections in “[Common Measurement Functions](#)” on page 58, and are included here for convenience.

Key Descriptions for Each Measurement

The Contents section for each Measurement is sub-divided into topics for each Front-panel key, in alphabetical order, as shown below.

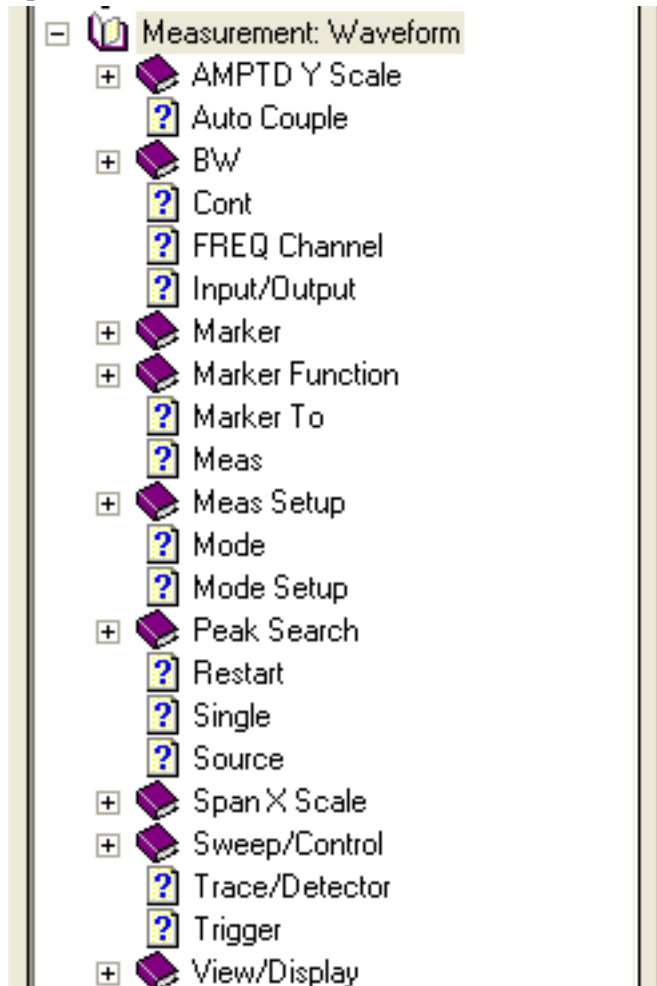

If you don't see a topic for a Front-panel key in the Measurement-specific section, then it is located in the section “[System Functions](#)” on page 56.

Key Information for Softkeys

Information for each softkey that appears when you press a Front-panel key (or a softkey with a submenu) is listed under the entry for that key in the Help Contents. The example below shows the submenu under the **SPAN X Scale** Front-panel key in the "Waveform" Measurement, alongside the

Using Help How Help is Organized

actual softkeys for that menu.

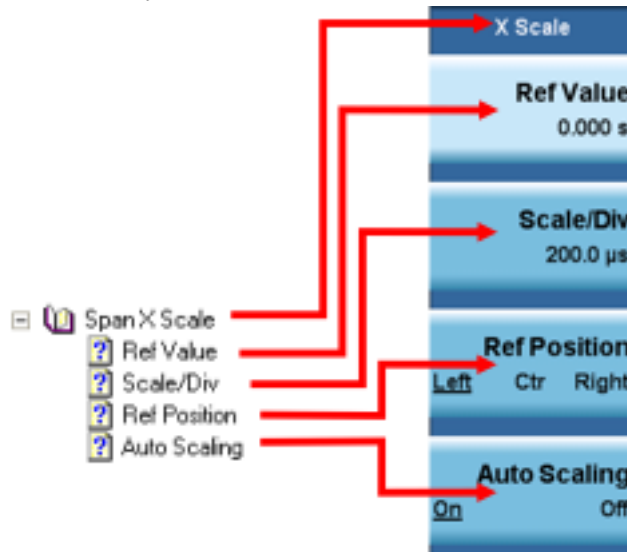

In these subsections, all softkeys are listed in the order they appear in their menu (that is, *not* in alphabetical order).

Common Measurement Functions

This section groups together function and key information that is shared between measurements. However, there is a listing for every Front-panel key and subkey in the section for each measurement, so you will generally not need to refer to this section.

The key subsections are listed alphabetically.

Front Panel Keys used by the Help System

The interactive Help system uses the Front-panel keys shown below.

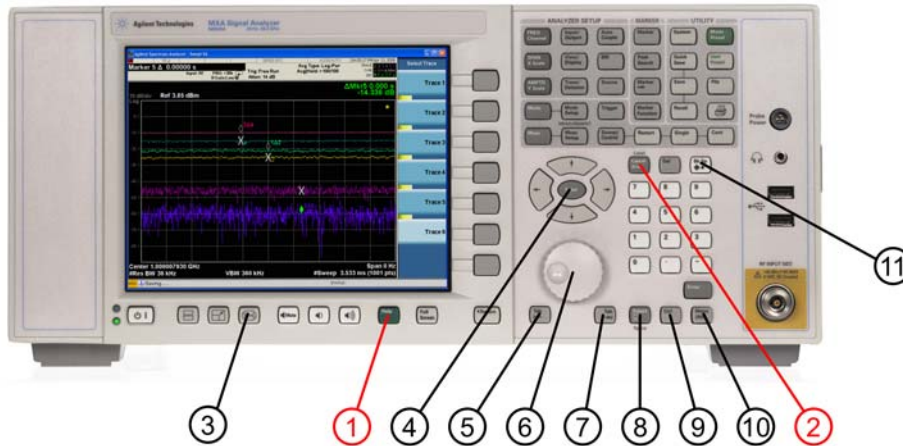

#	Item Name	Description
1	Help Key	Opens Help (displaying the topic for the last key pressed).
2	Cancel (Esc) Key	Exits Help.
3	Next Window Key	Changes the current window pane selection.
4	Arrow / Enter Keys	A central Enter key, surrounded by four directional arrow keys. Navigates within the Help system.
5	Backward Tab Key	Moves between controls in the Help display.
6	Knob	For future use.
7	Forward Tab Key	Moves between controls in the Help display.
8	Select / Space Key	Navigates within the Help system, in conjunction with other keys.
9	Ctrl Key	Navigates within the Help system, in conjunction with other keys. See “Navigating Windows HTML Help (CHM) Files” on page 60.
10	Alt Key	Navigates within the Help system, in conjunction with other keys. See “Navigating Windows HTML Help (CHM) Files” on page 60.
11	Bk Sp (Backspace) Key	Acts as a "Back" key when navigating the pages of the Help system.

Navigating Windows HTML Help (CHM) Files

HTML Help Window Components

When the interactive Help Window is open, the Analyzer's display appears as below.

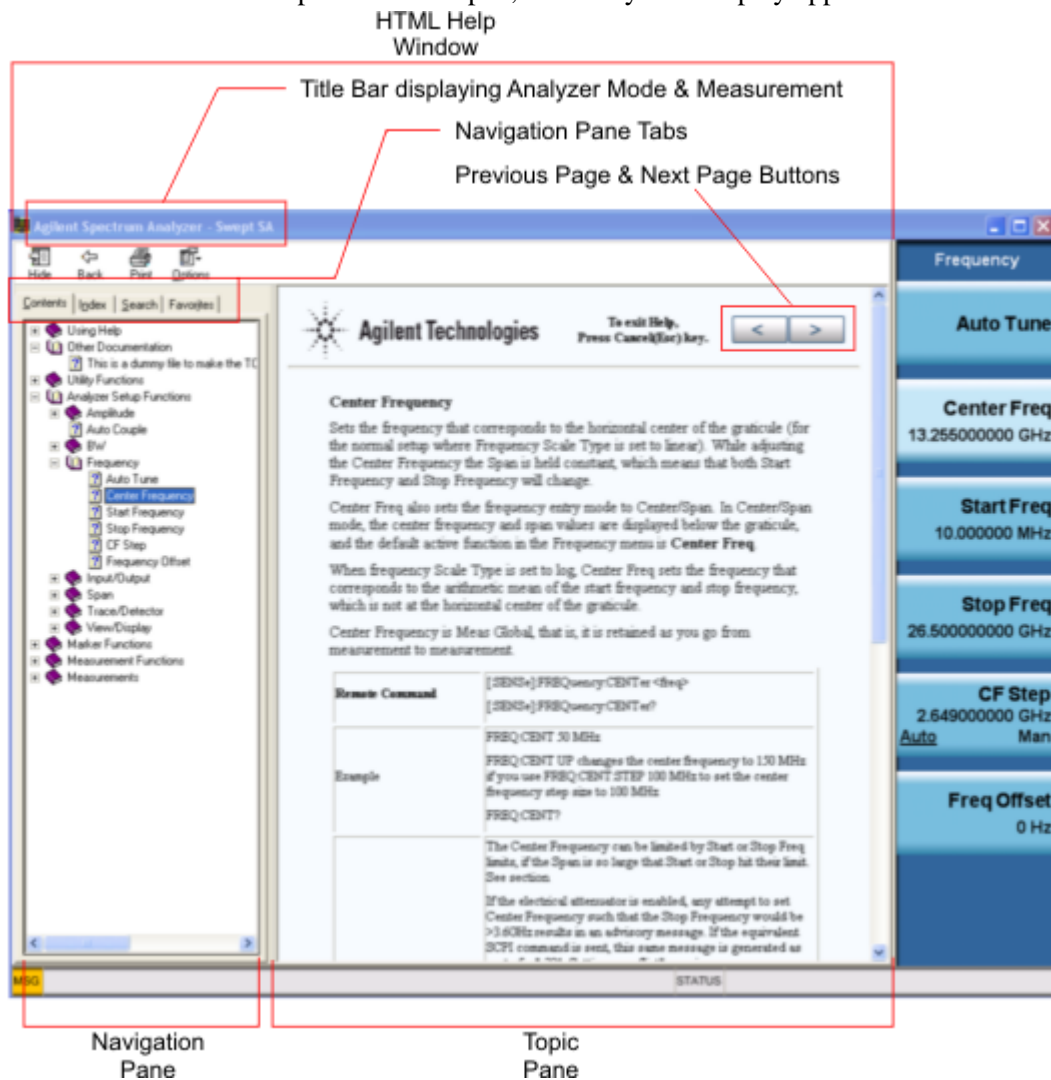

The HTML Help Window appears on top of, and to the left of, the measurement display. You can still see and use the current softkey menu when the HTML Help Window is open. However, pressing a softkey when the Help window is open displays Help for that softkey, but does *not* execute the softkey's function.

When the Help Window is open, the Analyzer retains its current Mode and Measurement, as shown in the Title Bar.

The HTML Help Window itself consists of two panes, as shown in the diagram above.

On the left is the Navigation Pane, and on the right is the Topic Pane.

The Help Window Navigation Pane

The Navigation Pane is further divided into four tabs: Contents, Index, Search and Favorites, as shown below.



For details of how to switch between these tabs, if you don't have a mouse attached to the Analyzer, see the Section [“To Switch the Active Tab within the Navigation Pane” on page 64](#).

The Help Window Topic Pane

This pane displays the text for the topic that you have selected. It also contains clickable **Previous Page** and **Next Page** buttons (as shown below), which can be used to move to the previous or next page in the Help file.



Basic Help Window Operations

This topic contains the following sections:

[“Opening Help” on page 61](#)

[“Getting Help for a Specific Key” on page 61](#)

[“Closing the Help Window” on page 62](#)

[“Viewing Help on How to Use Help” on page 62](#)

[“Exiting Help on How to Use Help” on page 62](#)

To locate the keys mentioned in this section, see [“Front Panel Keys used by the Help System” on page 59](#).

Opening Help

To access the Help system, press the green **Help** key below the front panel display (shown below) while an Agilent application is running.



Note that the softkeys remain visible when the Help window is open.

Getting Help for a Specific Key

1. If the Help window *is* already open, press the desired key. The relevant Help topic appears.

Note that the function normally invoked by the key is *not* executed when the key is pressed with the Help window open. If you want to execute the key's function, first close Help by pressing the **Cancel (Esc)** key (as described in [“Closing the Help Window” on page 62](#)), then press the key, before opening Help again (if required).

2. If the Help window is *not* already open, press the desired key (which executes the key's function), then press the **Help** key to display the relevant Help page. Help is available for all softkeys, and for all the Front-panel keys listed under the "System Functions" and "Measurement" sections.

For details of how to navigate within the panes of the Help window, see “[Navigating Windows HTML Help \(CHM\) Files](#)” on page 60.

Closing the Help Window

To close the Help window, and return to the measurement application, press the **Cancel (Esc)** key (depicted below).



Viewing Help on How to Use Help

With the Help window open, press the green **Help** key again.

The "Using Help" page appears, as shown below.



Exiting Help on How to Use Help

See the Section “[To Go Back or Forward: display the Previously-viewed or Next-viewed Topic in the Topic Pane](#)” on page 66 for details of several methods to accomplish this.

Navigating the Help Window

The way you navigate around the HTML Help Window depends on whether you have a mouse and keyboard attached to your Analyzer:

- If you have a mouse and keyboard attached, see the Section “[Navigating the Help Window with a Mouse](#)” on page 62.
- If you don't have a mouse and keyboard attached, see the Section “[Navigating the Help Window Without a Mouse](#)” on page 64.

Navigating the Help Window with a Mouse

When the HTML Help window is open, you can point-and-click to navigate, as you would when using Help for any Microsoft Windows computer application. The basic navigational features the Help systems of all X-Series Analyzers are as follows:

- If necessary, press the green **Help** key on the Front Panel, as described in “Opening Help” on page 61, to open the HTML Help window.
- Choose the desired topic from the list under the Contents Tab of the HTML Help Window’s Navigation Pane, then click on the topic title to display the first page of the topic.
- To expand the listing of a topic, click on the + icon to the left of the topic’s book icon, as shown below. A list of subtopics and pages appears.

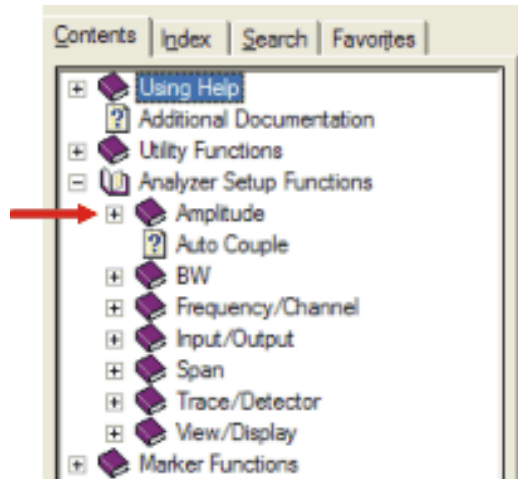

- To move to the Next or Previous Page within the Topic Pane, click the **Next Page** or **Previous Page** Keys (at the top right of the *Topic* Pane), as shown below.



Searching for a Help Topic If you also have a keyboard attached to the Analyzer, you can use the Help system’s full-text search feature to locate help for any topic, by typing in a key name, a topic name, or any other desired text.

Select the "Search" tab of the Help window’s Navigation Pane, then use the following procedure:

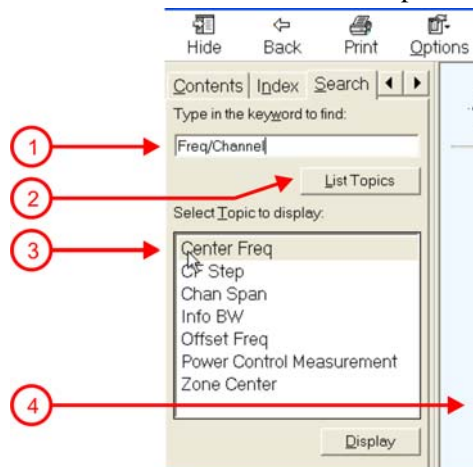

1. Type the desired topic name into the Search window as shown in the diagram above. Note that the text search is *not* case-sensitive.
2. Click on the **List Topics** button.

3. *Either:*

Double-click on the desired topic in the list,

Or:

Click on the desired topic to select it, then click the **Display** button beneath the list.

4. The topic is then displayed in the Topic Pane (right-hand side of display).

Navigating the Help Window Without a Mouse

Most features of the Help system can be accessed and navigated without the necessity to attach a mouse or keyboard to the Analyzer. There are, however, a few exceptions to this rule, which are noted in the Section [“Functions that cannot be used without a Mouse and Keyboard”](#) on page 67.

For information about how to perform common tasks in the Help system, click on one of the following links:

[“To Toggle the Focus between the Navigation Pane and the Topic Pane”](#) on page 64

[“To Switch the Active Tab within the Navigation Pane”](#) on page 64

[“To Scroll up or down the list of Topics within the Contents or Index Tabs of the Navigation Pane”](#) on page 65

[“To Expand or Collapse a selected topic within the Contents Tab of the Navigation Pane”](#) on page 65

[“To Display a selected Help topic in the Topic Pane from the Contents Tab of the Navigation Pane”](#) on page 65

[“To Display a Help topic in the Topic Pane from the Index Tab of the Navigation Pane”](#) on page 65

[“To Scroll up or down within a topic in the Topic Pane”](#) on page 66

[“To Go to the Next or Previous Page in the Topic Pane”](#) on page 66

[“To Go Back or Forward: display the Previously-viewed or Next-viewed Topic in the Topic Pane”](#) on page 66

[“To Scroll horizontally or vertically within the Contents Tab of the Navigation Pane”](#) on page 67

[“To Print the topic currently displayed”](#) on page 67

To locate all the keys mentioned in this section, see [“Front Panel Keys used by the Help System”](#) on page 59.

To Toggle the Focus between the Navigation Pane and the Topic Pane Press the **Next Window** key.



To Switch the Active Tab within the Navigation Pane Perform this procedure to display either the Contents, Index, Search or Favorites tab of the Help window’s Navigation Pane.

Hold down the **Ctrl** key, then press either the **Forward Tab** key, *or* the **Backward Tab** key.

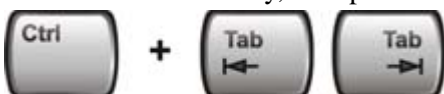

To Scroll up or down the list of Topics within the Contents or Index Tabs of the Navigation Pane

With the focus in the Navigation Pane, press the **Up Arrow** or **Down Arrow** keys.



To Expand or Collapse a selected topic within the Contents Tab of the Navigation Pane With the focus in the Navigation Pane, press the **Right Arrow** key to *expand* the selected topic:

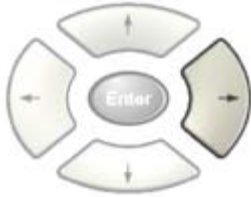

Or press the **Left Arrow** key to *collapse* the selected topic.



To Display a selected Help topic in the Topic Pane from the Contents Tab of the Navigation Pane

With the focus in the Contents Tab of the Navigation Pane, press the **Enter** key. If the selected topic was not already expanded, it expands in the Navigation Pane.

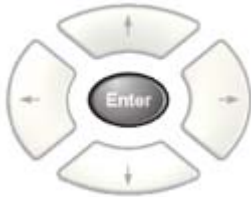

To Display a Help topic in the Topic Pane from the Index Tab of the Navigation Pane With the focus in the Index Tab of the Navigation Pane, press the **Enter** key.

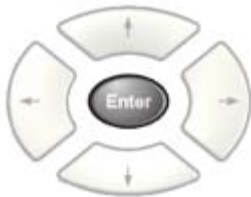

To Scroll up or down within a topic in the Topic Pane With the focus in the Topic Pane, press either the **Up Arrow** key or **Down Arrow** key.



To Go to the Next or Previous Page in the Topic Pane With the focus in the Topic Pane, press either **Forward Tab** or **Backward Tab** keys



to select the **> (Next Page)** key at the top right of the Pane, if you want to go to the *next* page,



or select the **< (Previous Page)** key at the top right of the Pane, if you want to go to the *previous* page.



Press **Enter**.



To Go Back or Forward: display the Previously-viewed or Next-viewed Topic in the Topic Pane

To go *back*, either:

Hold down the **Alt** key, then press the **Left Arrow** key.

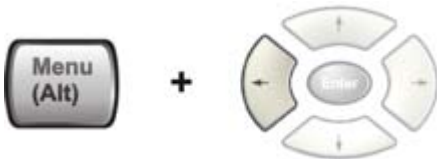

Or:

Press the **Bk Sp** key.



To go *forward*, hold down the **Alt** key, then press the **Right Arrow** key.

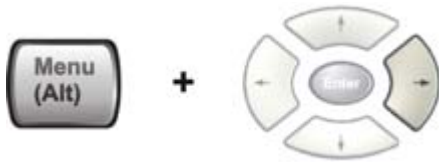

(The "Go Forward" operation has no effect unless there have been previous "Go Back" operations)

To Scroll horizontally or vertically within the Contents Tab of the Navigation Pane To scroll *horizontally*: with the focus in the Contents Tab of the Navigation Pane, hold down the **Ctrl** key, then press either the **Left Arrow** or **Right Arrow** keys.

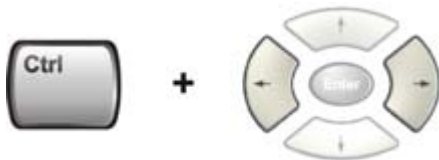

To scroll *vertically*: with the focus in the Contents Tab of the Navigation Pane, hold down the **Ctrl** key, then press either the **Up Arrow** or **Down Arrow** keys.



To Print the topic currently displayed Press the Front-panel **Print** key



Functions that cannot be used without a Mouse and Keyboard The following parts of the HTML Help System *cannot* easily be used without attaching a mouse and keyboard to the Analyzer.

- The menu options at the top of the Help Window, consisting of: **Hide**, **Back**, **Print** and **Options**.
- The functionality of the Search Tab of the Navigation Pane.
- The functionality of the Favorites Tab of the Navigation Pane.

Navigating Acrobat (PDF) Files

IMPORTANT To navigate PDF files effectively, you must attach a mouse and keyboard to the Analyzer.

If it is not possible to attach a mouse and keyboard to the Analyzer, you should copy the PDF file to a separate computer, then open it on that computer. Every PDF file that is present on the Analyzer's hard disk can also be found on the Documentation CD shipped with the Analyzer. For details, see ["Copying the Acrobat \(PDF\) Files" on page 54](#).

Adobe Reader Window

When an Adobe Acrobat (PDF) file is open and being viewed, the Analyzer's display appears as below.

Note that, unlike the HTML Help Window, the Acrobat Reader Window is *not* embedded in the Analyzer's Application window. It is a separate window, which can be resized, moved and closed independently of the Application window.

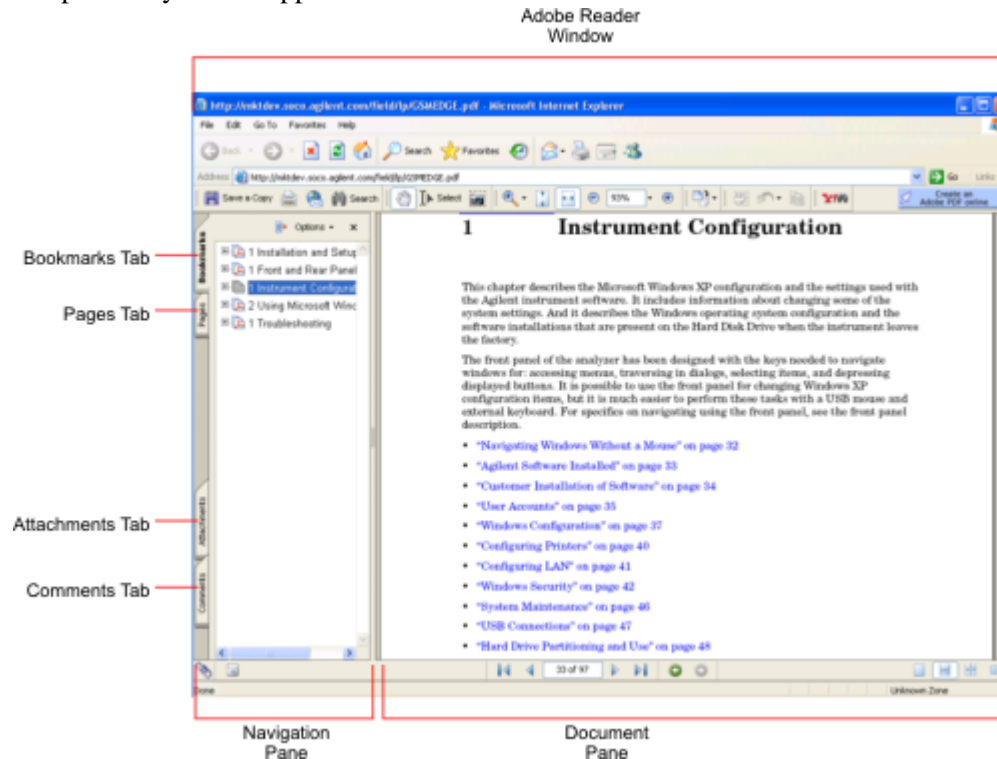

The Adobe Reader Window itself consists of two panes, as shown in the diagram above.

On the left is the Navigation Pane (which may be hidden), and on the right is the Document Pane.

The Navigation Pane is further subdivided into four tabs: Bookmarks, Pages, Attachments and Comments. Typically, PDF files supplied with the Agilent X-Series Analyzers contain useful content only under the Bookmarks and Pages Tabs: the Attachments and Comments Tabs are not used.

Navigating the Acrobat Reader Window

The online Help for Adobe Reader provides detailed information on how to use the Reader. To access the online Help, do the following:

- With the Adobe Reader window open, click **Help, Adobe Reader Help** in the menu at the top of the screen. This opens the Help window on top of the document window.
- To close the Help window, *either* click the Red **X** at the top right of the window, *or* right-click



anywhere in the title bar, then select **Close** from the popup menu.

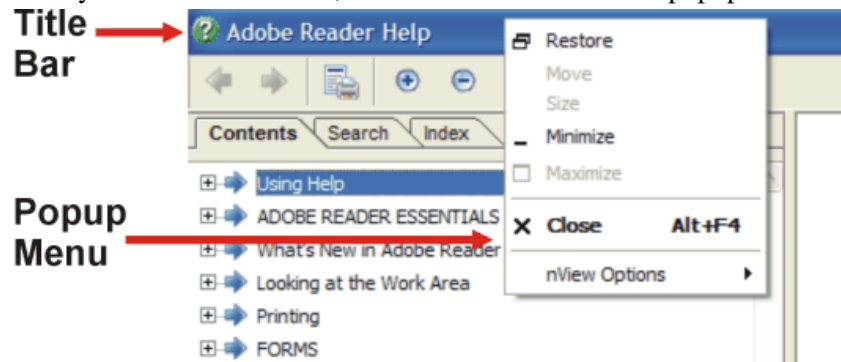

Printing Acrobat Files

NOTE The driver for the appropriate printer must be installed on the Analyzer's hard disk before any file can be printed.

To print all or part of an open Acrobat file, do the following.

1. *Either*,
 - a. click on the Print icon in the Acrobat Reader toolbar,



- b. *or*, select File > Print from the menu.

Terms Used in This Documentation

Many special terms are used throughout this documentation. Please refer to the "Getting Started Guide" for detailed explanations of all these terms.

The Section below provides a brief description of special terms used in the Key parameter tables.

Terms used in Key Parameter Tables

The following terms are used in the parameter tables for each Front-panel key or softkey. However, a particular key description may not use all the terms listed.

Term	Meaning
Default Unit	The default measurement unit of the setting.
Default Terminator	Indicates the units that will be attached to the numeric value that you have entered. This default will be used from the front panel, when you terminate your entry by pressing the Enter key, rather than selecting a units key. This default will be used remotely when you send the command without specifying any units after your value(s).
Dependencies/ Couplings	Some commands may be unavailable when other parameters are set in certain ways. If applicable, any such limitations are described here.
Example	Provides command examples using the indicated remote command syntax.
Factory Preset	Describes the function settings after a Factory Preset .
Key Path	The sequence of Front-panel keys that accesses the function or setting.
Knob Increment/Decrement	The numeric value of the minimum increment or decrement that is applied when turning the thumb wheel knob.
Max	The Maximum numerical value that the setting can take.
Min	The Minimum numerical value that the setting can take.
Meas Global	The functionality described is the same in all measurements.
Meas Local	The functionality described is only true for the measurement selected.
Mode Global	The functionality described is the same for all modes.
Preset	In some cases, a Preset operation changes the status of a parameter. If the operation of the key specified is modified by a Preset operation, the effect is described here.
Range	Describes the range of the smallest to largest values to which the function can be set. If you try to set a value below the minimum value, the analyzer defaults to the minimum value. If you try to set a value above the maximum value, the analyzer defaults to the maximum value.
Remote Command	Shows the syntax requirements for each SCPI command.

Using Help
Terms Used in This Documentation

Term	Meaning
Remote Command Notes	Additional notes regarding Remote Commands.
Resolution	Specifies the smallest change that can be made to the numeric value of a parameter.
SCPI Status Bits/OPC Dependencies	Pressing certain keys may affect one or more status bits. If applicable, details are given here.
State Saved	Indicates what happens to a particular function when the Analyzer state is saved (either to an external memory device or the internal D: drive). It also indicates whether the current settings of the function are maintained if the Analyzer is powered on or preset using Power On Last State or User Preset .

Context Sensitive Help not Available

You have been directed to this page because interactive help for the key you selected is not available.



The following information may help you to find related topics of interest:

- If your Analyzer has an attached Mouse and Keyboard, see the Section [“Searching for a Help Topic” on page 63](#).
- If your Analyzer does *not* have an attached Mouse and Keyboard, see the Section [“Finding a Topic without a Mouse and Keyboard” on page 73](#) below.
- If you want to learn how to select on-page links *without* a Mouse attached to your Analyzer, see the Section [“Selecting a Hyperlink without a Mouse” on page 74](#) below.

TIP If you want to understand the organization of Help, see the Section [“How Help is Organized” on page 56](#).





Finding a Topic without a Mouse and Keyboard

Follow this procedure when you want to display a different Help topic by selecting it from the Contents tab of the Help window’s Navigation Pane, but you do not have a mouse attached to the Analyzer.

Perform this action:	Using these keys:
1. If necessary, toggle the focus between the Contents tab of the Navigation Pane (left side of display) and the Topic Pane (right side of display) by pressing the Next Window key. Ensure that the focus is in the <i>Contents tab of the Navigation Pane</i> .	
2. Move up or down the Contents list, by pressing the Up Arrow or Down Arrow keys. Topics become highlighted upon selection.	
3. Display the selected topic, by pressing the Enter key.	

Selecting a Hyperlink without a Mouse

Follow this procedure when you want to select and follow a hyperlink on a Help page, but you do not have a mouse attached to the Analyzer.

Perform this action:	Using these keys:
<p>1. If necessary, toggle the focus between the Contents tab of the Navigation Pane (left side of display) and the Topic Pane (right side of display) by pressing the Next Window key.</p> <p>Ensure that the focus is in the <i>Topic Pane</i>.</p>	
<p>2. Move from link to link in the Topic Pane (right side of display) by pressing the Forward Tab and Backward Tab keys. Links become highlighted upon selection.</p> <p>NOTE: When a Help page is first displayed, no link is selected. Clicking the Forward Tab key once selects the Previous Page key. Clicking the Forward Tab key a second time selects the Next Page key. Clicking the Forward Tab key for a third time selects the first hyperlink on the page.</p> <p>It is sometimes difficult to see the highlighting of the Previous and Next Page keys.</p>	<p>Use the Forward and Backward Tab keys</p>  <p>to select the Previous and Next Page keys</p> 
<p>3. When you have selected the desired link, activate it by pressing the Enter key.</p>	

The X-Series signal analyzer measures and monitors complex RF and microwave signals. Analog baseband analysis is available on MXA. The analyzer integrates traditional spectrum measurements with advanced vector signal analysis to optimize speed, accuracy, and dynamic range. The analyzer has Windows XP Pro[®] built in as an operating system, which expands the usability of the analyzer.

With a broad set of applications and demodulation capabilities, an intuitive user interface, outstanding connectivity and powerful one-button measurements, the analyzer is ideal for both R&D and manufacturing engineers working on cellular, emerging wireless communications, general purpose, aerospace and defense applications.

Installing Application Software

When you want to install a measurement application after your initial hardware purchase, you actually only need to license it. All of the available applications are loaded in your analyzer at the time of purchase.

So when you purchase an application, you will receive an entitlement certificate that is used to obtain a license key for that particular measurement application. Enter the license key that you obtain into the N9020A Signal Analyzer to activate the new measurement application. See below for more information.

For the latest information on Agilent Signal Analyzer measurement applications and upgrade kits, visit the following internet URL.

http://www.agilent.com/find/sa_upgrades

Viewing a License Key

Measurement personalities purchased with your instrument have been installed and activated at the factory before shipment. The instrument requires a unique **License Key** for every measurement application purchased. The license key is a hexadecimal string that is specific to your measurement application, instrument model number and serial number. It enables you to install, or reactivate that particular application.

Press **System, Show, System** to display which measurement applications are currently licensed in your analyzer.

Go to the following location to view the license keys for the installed measurement applications:

C:\Programing Files\Agilent\Licensing

NOTE	You may want to keep a copy of your license key in a secure location. You can print out a copy of the display showing the license numbers to do this. If you should lose your license key, call your nearest Agilent Technologies service or sales office for assistance.
-------------	---

Obtaining and Installing a License Key

If you purchase an additional application that requires installation, you will receive an “Entitlement Certificate” which may be redeemed for a license key for one instrument. Follow the instructions that accompany the certificate to obtain your license key.

Installing a license key for the selected application can be done automatically using a USB memory device. To do this, you would put the license file on the USB memory device at the root level. Follow the instructions that come with your software installation kit.

Installing a license key can also be done manually using the license management application in the instrument. It is found through the instrument front panel keys at **System, Licensing. . .**, or internally at C:\Programming Files\Agilent\Licensing.

NOTE You can also use these procedures to reinstall a license key that has been accidentally deleted, or lost due to a memory failure.

Missing and Old Measurement Application Software

All the software applications were loaded at the time of original instrument manufacture. It is a good idea to regularly update your software with the latest available version. This assures that you get any improvements and expanded functionality that is available.

Because the software was loaded at the initial purchase, there may be additional measurement applications that are now available. If the application you are interested in licensing is not available, you will need to do a software update. (Press **System, Show, System.**)

Check the Agilent internet website for the latest software versions available for downloading:

http://www.agilent.com/find/mxa_software
http://www.agilent.com/find/exa_software

You must load the updated software package into the analyzer from a USB drive, or directly from the internet. An automatic loading program is included with the files.

X-Series Options and Accessories

[“MXA Instrument Options” on page 77](#)

[“MXA Accessories” on page 78](#)

[“EXA Instrument Options” on page 78](#)

[“EXA Accessories” on page 79](#)

[“Advanced Measurement Application Software” on page 79](#)

MXA Instrument Options

Product	Description
N9020A	MXA Signal Analyzer
N9020A-503	Frequency range from 20 Hz to 3.6 GHz
N9020A-508	Frequency range from 20 Hz to 8.4 GHz
N9020A-513	Frequency range from 20 Hz to 13.6 GHz
N9020A-526	Frequency range from 20 Hz to 26.5 GHz
N9020A-B25	Analysis bandwidth, 25 MHz
N9020A-BBA	Analog baseband IQ inputs
N9020A-PFR	Precision frequency reference
N9020A-PRC	Portable configuration

About the Analyzer
Installing Application Software

Product	Description
N9020A-EA3	Electric attenuator, 3.6 GHz
N9020A-S40	Baseband analysis bandwidth, 40 MHz/channel
N9020A-P03	Preamplifier, 3.6 GHz
N9020A-P08	Preamplifier, 8.4 GHz
N9020A-P13	Preamplifier, 13.6 GHz
N9020A-P26	Preamplifier, 26.5 GHz

MXA Accessories

Product	Description
N9020A-MLP	75 ohm minimum loss pad
N9020A-EFM	USB flash drive
N9020A-DVR	DVD-ROM drive
N9020A-MSE	Mouse, USB interface
N9020A-KYB	Keyboard, USB interface
N9020A-HTC	Hard transit case
N9020A-1CP	Rackmount kit with handles
N9020A-1CN	Front handle kit
N9020A-1CM	Rackmount kit
N9020A-1CR	Rack slide kit
N9020A-CPU	Instrument security, additional CPU and HDD
N9020A-UK6	Commercial Calibration Certificate with Test Data
N9020A-1A7	ISO 17025 Compliant Calibration
N9020A-A6J	ANSI Z540 Compliant Calibration

EXA Instrument Options

Product	Description
N9010A	EXA Signal Analyzer (3.6, 7.0, 13.6, and 26.5 GHz)
N9010A-503	Frequency range from 9 kHz to 3.6 GHz
N9010A-507	Frequency range from 9 kHz to 7.0 GHz
N9010A-513	Frequency range from 9 kHz to 13.6 GHz
N9010A-526	Frequency range from 9 kHz to 26.5 GHz

Product	Description
N9010A-FSA	Fine step attenuator
N9010A-PFR	Precision frequency reference
N9010A-PRC	Portable configuration
N9010A-EA3	Electric attenuator, 3.6 GHz
N9010A-P03	Preamplifier, 3.6 GHz

EXA Accessories

Product	Description
N9010A-MLP	Minimum loss pad, 50 to 75 ohms
N9010A-EFM	USB flash drive
N9010A-DVR	DVD-ROM/CD-R/RW drive
N9010A-MSE	Mouse, USB interface
N9010A-KYB	Keyboard, USB interface
N9010A-HTC	Hard transit case
N9010A-1CP	Rackmount kit with handles
N9010A-1CN	Front handle kit
N9010A-1CM	Rackmount kit
N9010A-1CR	Rack slide kit
N9010A-CPU	Instrument security, additional CPU and HDD
N9010A-UK6	Commercial Calibration Certificate with Test Data
N9010A-1A7	ISO 17025 Compliant Calibration
N9010A-A6J	ANSI Z540 Compliant Calibration

Advanced Measurement Application Software

For a current list of application software, go to the following URLs.

For MXA,

<http://www.agilent.com/find/mxa/options>

Select the *MXA N9020A, Options and Measurement Applications* link on the top of the page.

For EXA,

<http://www.agilent.com/find/exa/options>

Select the *EXA N9010A, Options and Measurement Applications* link on the top of the page.

Front-Panel Features

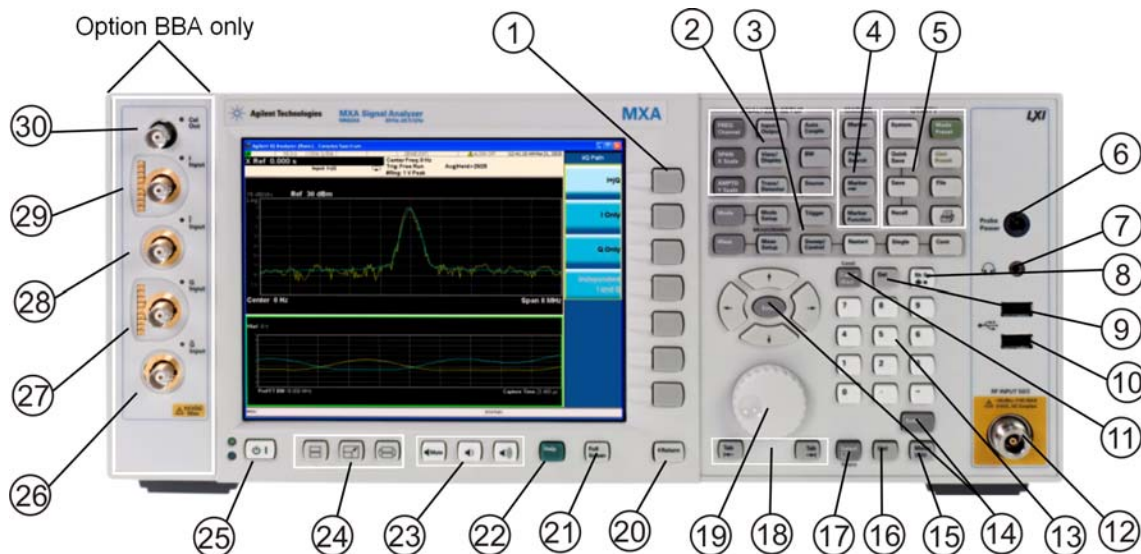

Item		Description
#	Name	
1	Menu Keys	Key labels appear to the left of the menu keys to identify the current function of each key. The displayed functions are dependent on the currently selected Mode and Measurement, and are directly related to the most recent key press.
2	Analyzer Setup Keys	These keys set the parameters used for making measurements in the current Mode and Measurement.
3	Measurement Keys	These keys select the Mode, and the Measurement within the mode. They also control the initiation and rate of recurrence of measurements.
4	Marker Keys	Markers are often available for a measurement, to measure a very specific point/segment of data within the range of the current measurement data.
5	Utility Keys	These keys control system-wide functionality such as: <ul style="list-style-type: none"> • instrument configuration information and I/O setup, • printer setup and printing, • file management, save and recall, • instrument presets.
6	Probe Power	Supplies power for external high frequency probes and accessories.
7	Headphones Output	Headphones can be used to hear any available audio output.
8	Back Space Key	Press this key to delete the previous character when entering alphanumeric information. It also works as the Back key in Help and Explorer windows.

Item		Description
#	Name	
9	Delete Key	Press this key to delete files, or to perform other deletion tasks.
10	USB Connectors	Standard USB 2.0 ports, Type A. Connect to external peripherals such as a mouse, keyboard, DVD drive, or hard drive.
11	Local/Cancel/(Esc) Key	<p>If you are in remote operation, Local:</p> <ul style="list-style-type: none"> returns instrument control from remote back to local (the front panel). turns the display on (if it was turned off for remote operation). can be used to clear errors. (Press the key once to return to local control, and a second time to clear error message line.) <p>If you have not already pressed the units or Enter key, Cancel exits the currently selected function without changing its value.</p> <p>Esc works the same as it does on a pc keyboard. It:</p> <ul style="list-style-type: none"> exits Windows dialogs clears errors aborts printing cancels operations.
12	RF Input	Connector for inputting an external signal. Make sure that the total power of all signals at the analyzer input does <i>not</i> exceed +30 dBm (1 watt).
13	Numeric Keypad	Enters a specific numeric value for the current function. Entries appear on the upper left of the display, in the measurement information area.
14	Enter and Arrow Keys	<p>The Enter key terminates data entry when either no unit of measure is needed, or you want to use the default unit.</p> <p>The arrow keys:</p> <ul style="list-style-type: none"> Increment and decrement the value of the current measurement selection. Navigate help topics. Navigate, or make selections, within Windows dialogs. Navigate within forms used for setting up measurements. Navigate within tables. <p>NOTE The arrow keys cannot be used to move a mouse pointer around on the display.</p>
15	Menu/ (Alt) Key	Alt works the same as a pc keyboard. Use it to change control focus in Windows pull-down menus.
16	Ctrl Key	Ctrl works the same as a pc keyboard. Use it to navigate in Windows applications, or to select multiple items in lists.
17	Select / Space Key	Select is also the Space key and it has typical pc functionality. For example, in Windows dialogs, it selects files, checks and unchecks check boxes, and picks radio button choices. It opens a highlighted Help topic.
18	Tab Keys	Use these keys to move between fields in Windows dialogs.
19	Knob	Increments and decrements the value of the current active function.
20	Return Key	Exits the current menu and returns to the previous menu. Has typical pc functionality.

About the Analyzer
Front-Panel Features

Item		Description
#	Name	
21	Full Screen Key	Pressing this key turns off the softkeys to maximize the graticule display area. Press the key again to restore the normal display.
22	Help Key	Initiates a context-sensitive Help display for the current Mode. Once Help is accessed, pressing a front panel key brings up the help topic for that key function.
23	Speaker Control Keys	Enables you to increase or decrease the speaker volume, or mute it.
24	Window Control Keys	These keys select between single or multiple window displays. They zoom the current window to fill the data display, or change the currently selected window. They can be used to switch between the Help window navigation pane and the topic pane.
25	Power Standby/ On	Turns the analyzer on. A green light indicates power on. A yellow light indicates standby mode. <div style="background-color: #cccccc; padding: 2px; display: inline-block; margin-bottom: 5px;">NOTE</div> <p>The front-panel switch is a standby switch, <i>not</i> a LINE switch (disconnecting device). The analyzer continues to draw power even when the line switch is in standby.</p> <p>The main power cord can be used as the system disconnecting device. It disconnects the mains circuits from the mains supply.</p>
26	\bar{Q} Input	Input port for the Q channel when in differential mode.*
27	Q Input	Input port for the Q channel for either single or differential mode.*
28	\bar{I} Input	Input port for the I channel when in differential mode.*
29	I Input	Input port for the I channel for either single or differential mode.*
30	Cal Out	Output port for calibrating the I, \bar{I} , Q and \bar{Q} inputs and probes used with these inputs.*

*. Status of the LED indicates whether the current state of the port is active (green) or is not in use (dark).

Overview of key types

The keys labeled **FREQ Channel**, **System**, and **Marker Functions** are all examples of front-panel keys. Most of the dark or light gray keys access menus of functions that are displayed along the right side of the display. These displayed key labels are next to a column of keys called menu keys.

Menu keys list functions based on which front-panel key was pressed last. These functions are also dependant on the current selection of measurement application (**Mode**) and measurement (**Meas**).

If the numeric value of a menu key function can be changed, it is called an active function. The function label of the active function is highlighted after that key has been selected. For example, press **AMPTD Y Scale**. This calls up the menu of related amplitude functions. The function labeled **Ref Level** (the default selected key in the Amplitude menu) is highlighted. **Ref Level** also appears in the upper left of the display in the measurement information area. The displayed value indicates that the function is selected and its value can now be changed using any of the data entry controls.

Some menu keys have multiple choices on their label, such as **On/Off** or **Auto/Man**. The different choices are selected by pressing the key multiple times. For example, the Auto/Man type of key. To select the function, press the menu key and notice that Auto is underlined and the key becomes highlighted. To change the function to manual, press the key again so that Man is underlined. If there are more than two settings on the key, keep pressing it until the desired selection is underlined.

When a menu first appears, one key label is highlighted to show which key is the default selection. If you press **Marker Function**, the **Marker Function Off** key is the menu default key, and is highlighted.

Some of the menu keys are grouped together by a yellow bar running behind the keys near the left side or by a yellow border around the group of keys. When you press a key within the yellow region, such as **Marker Noise**, the highlight moves to that key to show it has been selected. The keys that are linked are related functions, and only one of them can be selected at any one time. For example, a marker can only have one marker function active on it. So if you select a different function it turns off the previous selection. If the current menu is two pages long, the yellow bar or border could include keys on the second page of keys.



In some key menus, a key label is highlighted to show which key has been selected from multiple available choices. And the menu is immediately exited when you press one of the other keys. For example, when you press the **Select Trace** key (in the **Trace/Detector** menu), it brings up its own menu of keys. The **Trace 1** key is highlighted. When you press the **Trace 2** key, the highlight moves to that key and the screen returns to the **Trace/Detector** menu.

If a displayed key label shows a small solid-black arrow tip pointing to the right, it indicates that additional key menus are available. If the arrow tip is not filled in solid then pressing the key the first time selects that function. Now the arrow is solid and pressing it again brings up an additional menu of settings.

Display Annotations

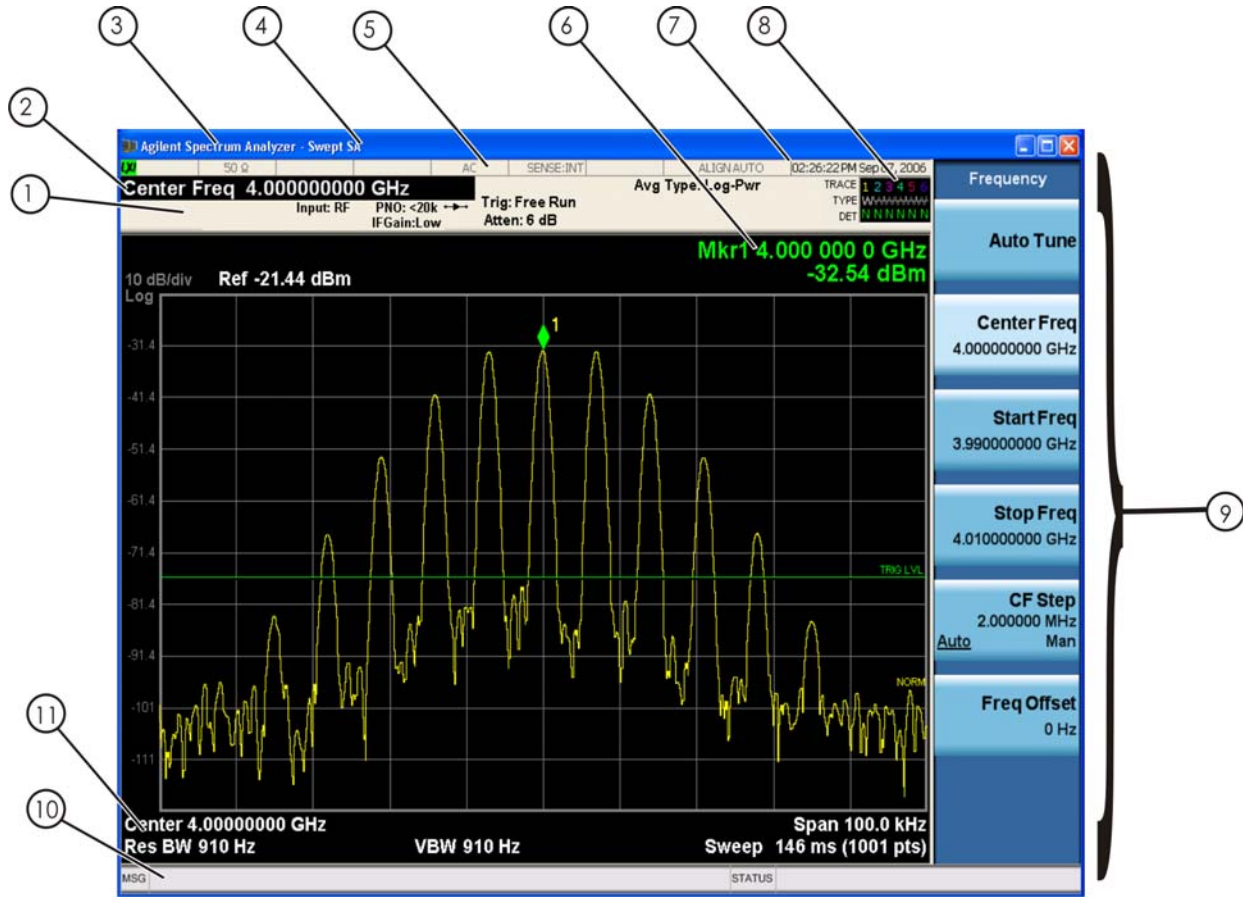
This section describes the display annotation as it is on the Spectrum Analyzer Measurement Application display. Other measurement application modes have some annotation differences.



Item	Description	Function Keys
1	Measurement bar - Shows general measurement settings and information.   Indicates single/continuous measurement. Some measurements include limits that the data is tested against. A Pass/Fail indication may be shown in the lower left of the measurement bar.	All the keys in the Analyzer Setup part of the front panel.
2	Active Function (measurement bar) - when the current active function has a settable numeric value, it is shown here.	Currently selected front panel key.
3	Banner - shows the name of the selected application that is currently running.	Mode
4	Measurement title - shows title information for the current measurement, or a title that you created for the measurement.	Meas View/Display, Display, Title

Item	Description	Function Keys
5	Settings panel - displays system information that is not specific to any one application. <ul style="list-style-type: none"> • Input/Output status - green LXI indicates the LAN is connected. RLTS indicate Remote, Listen, Talk, SRQ • Input impedance and coupling • Selection of external frequency reference • Setting of automatic internal alignment routine 	Local and System, I/O Config Input/Output, Amplitude, System and others
6	Active marker frequency, amplitude or function value	Marker
7	Settings panel - time and date display.	System, Control Panel
8	Trace and detector information	Trace/Detector, Clear Write (W) Trace Average (A) Max Hold (M) Min Hold (m) Trace/Detector, More, Detector, Average (A) Normal (N) Peak (P) Sample (S) Negative Peak (p)
9	Key labels that change based on the most recent key press.	Softkeys
10	Displays information, warning and error messages. Message area - single events, Status area - conditions	
11	Measurement settings for the data currently being displayed in the graticule area. In the example above: center frequency, resolution bandwidth, video bandwidth, frequency span, sweep time and number of sweep points.	Keys in the Analyzer Setup part of the front panel.

Rear-Panel Features

MXA and EXA with Option PC2

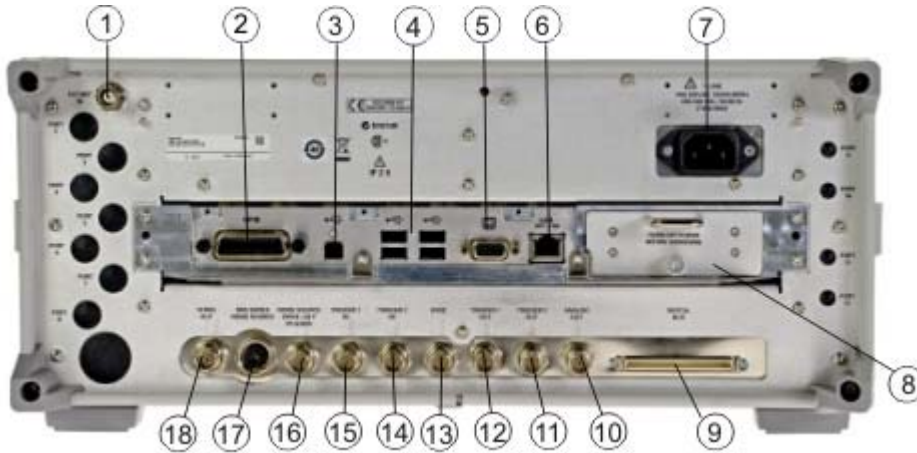

EXA



Item		Description
#	Name	
1	EXT REF IN	Input for an external frequency reference signal: For MXA – 1 to 50 MHz For EXA – 10 MHz.
2	GPIB	A General Purpose Interface Bus (GPIB, IEEE 488.1) connection that can be used for remote analyzer operation.

Item		Description
#	Name	
3	USB Connector	USB 2.0 port, Type B. USB TMC (test and measurement class) connects to an external pc controller to control the instrument and for data transfers over a 480 Mbps link.
4	USB Connectors	Standard USB 2.0 ports, Type A. Connect to external peripherals such as a mouse, keyboard, printer, DVD drive, or hard drive.
5	MONITOR	Allows connection of an external VGA monitor.
6	LAN	A TCP/IP Interface that is used for remote analyzer operation.
7	Line power input	The AC power connection. See the product specifications for more details.
8	Removable Disk Drive	Standard on MXA. Optional on EXA.
9	Digital Bus	Reserved for future use.
10	Analog Out	Reserved for future use.
11	TRIGGER 2 OUT	A trigger output used to synchronize other test equipment with the analyzer. Configurable from the Input/Output keys.
12	TRIGGER 1 OUT	A trigger output used to synchronize other test equipment with the analyzer. Configurable from the Input/Output keys.
13	Sync	Reserved for future use.
14	TRIGGER 2 IN	Allows external triggering of measurements.
15	TRIGGER 1 IN	Allows external triggering of measurements.
16	Noise Source Drive +28 V (Pulsed)	For use with Agilent 346A, 346B, and 346C Noise Sources
17	SNS Series Noise Source	For use with Agilent N4000A, N4001A, N4002A Smart Noise Sources (SNS).
18	10 MHz OUT	An output of the analyzer internal 10 MHz frequency reference signal. It is used to lock the frequency reference of other test equipment to the analyzer.

Window Control Keys

The instrument provides three front-panel keys for controlling windows. They are **Multi Window**, **Zoom**, and **Next Window**. These are all “immediate action” keys.

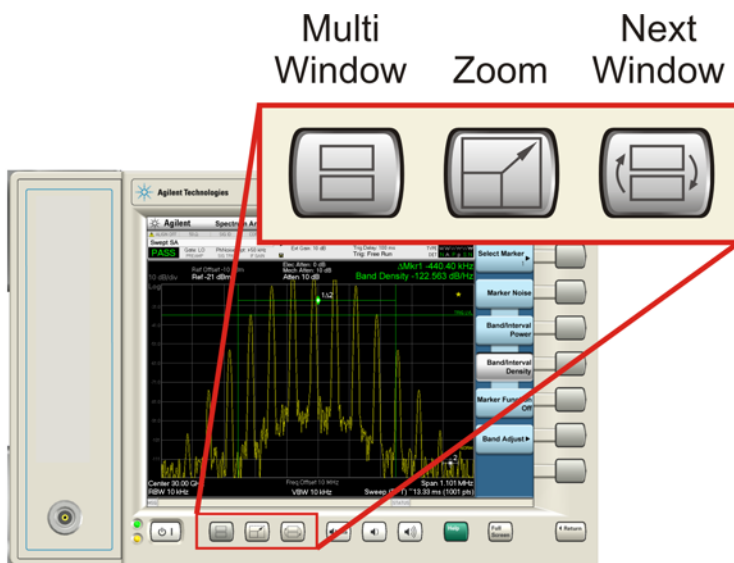

Multi-Window

The **Multi Window** front-panel key is not used at this time. It is there to support future functionality.

Key Path	Front-panel key
Help Map ID	3496
Instrument S/W Revision	Prior to A.02.00

Zoom

Zoom is a toggle function. Pressing once Zooms the selected window; pressing again un-zooms.

When Zoom is on for a window, that window will get the entire primary display area. The zoomed window, since it is the selected window, is outlined in green.

Zoom is local to each Measurement. Each Measurement remembers its Zoom state. The Zoom state of each Measurement is part of the Mode's state.

NOTE Data acquisition and processing for the other windows continues while a window is zoomed, as does all SCPI communication with the other windows.

Remote Command: :DISPlay:WINDow:FORMat:ZOOM

Remote Command: :DISPlay:WINDow:FORMat:TILE
Example: :DISP:WIND:FORM:ZOOM sets zoomed
 :DISP:WIND:FORM:TILE sets un-zoomed
Preset: TILE
Help Map ID: 3497
Instrument S/W Revision: Prior to A.02.00

Next Window

This key selects the next window of the current view.

When this key is selected in Help Mode, it toggles focus between the table of contents window and the topic pane window.

Remote Command: :DISPlay:WINDow[:SElect] <number>
 :DISPlay:WINDow[:SElect]?
Example: :DISP:WIND 1
Preset: 1
Min: 1
Max: If <number> is greater than the number of windows, limit to <number of windows>
Help Map ID: 0
Instrument S/W Revision: Prior to A.02.00

Selected Window

One and only one window is always selected. The selected window has the focus; as far as you are concerned, all key presses are going to that window.

If a window is not selected, its boundary is gray. The selected window has a green boundary.

If a window in a multi-window display is zoomed it is still outlined in green. If there is only one window, the green outline is not used. This allows you to distinguish between a zoomed window and a display with only one window.

The selected window is local to each Measurement. Each Measurement remembers which window is selected. The selected window for each Measurement is remembered in Mode state.

Navigating Windows

When the Next Window key is pressed, the next window in the order of precedence (see below) becomes selected. If the selected window was zoomed, the next window will also be zoomed.

The window navigation does NOT use the arrow and select keys. Those are reserved for navigation within a window.

Mouse and Keyboard Control

If you do not have access to the instrument front-panel, there are several ways that a mouse and PC Keyboard can give you access to functions normally accessed using the front-panel keys.

Right-Click

If you plug in a mouse and right-click on the analyzer screen, a menu will appear as below:

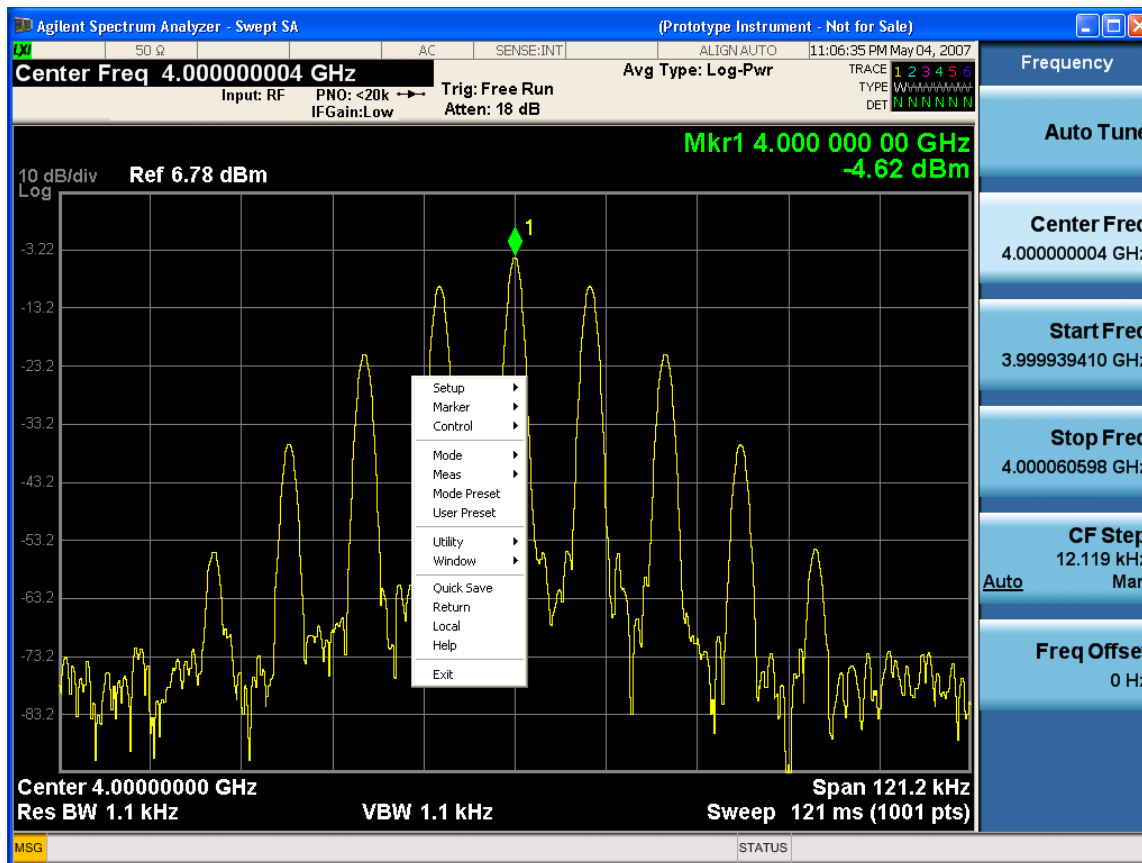

Placing the mouse on one of the rows marked with a right arrow symbol will cause that row to expand, as for example below where the mouse is hovered over the “Utility” row:

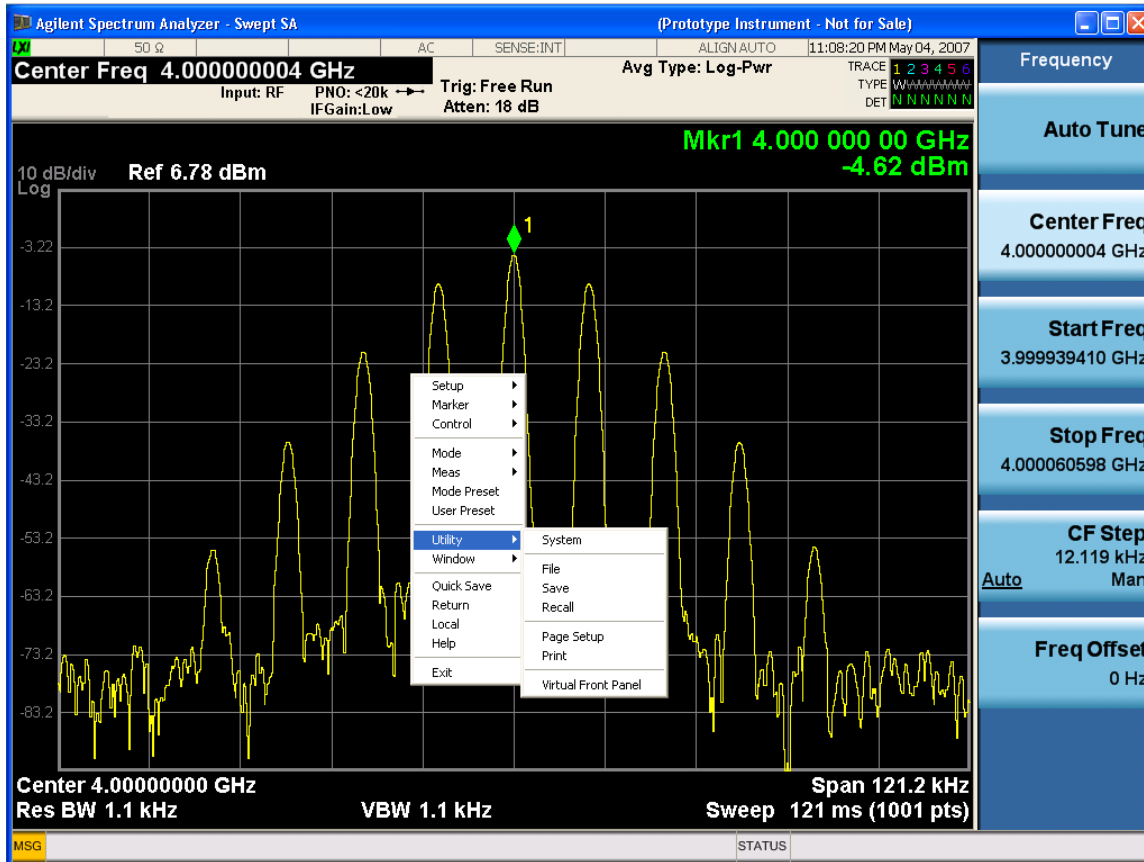

This method can be used to access any of the front-panel keys by using a mouse; as for example if you are accessing the instrument through Remote Desktop.

The array of keys thus available is shown below:

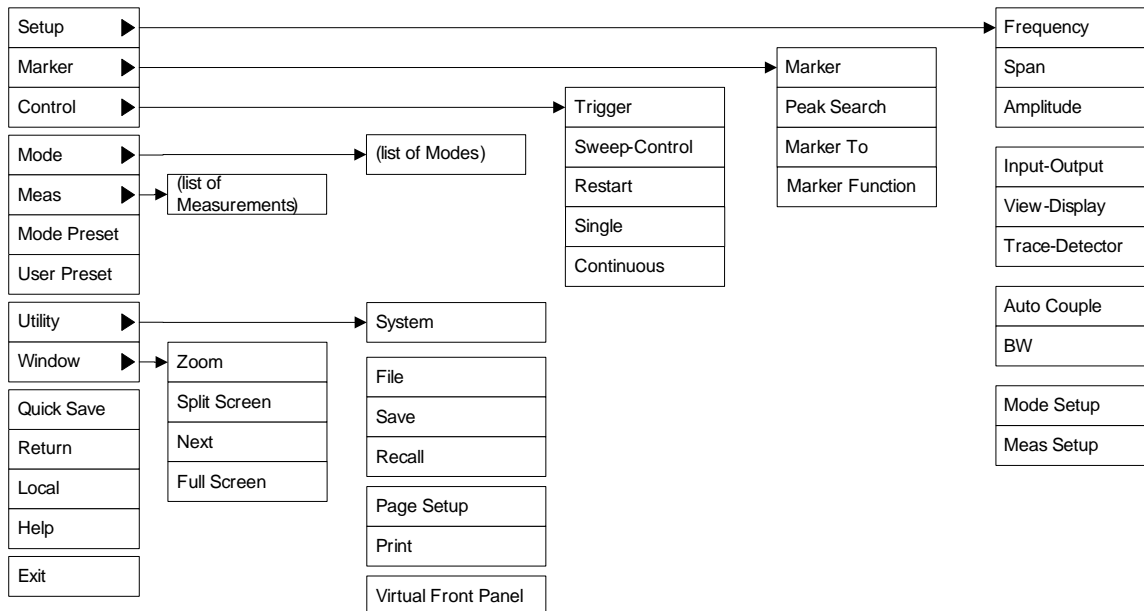

PC Keyboard

If you have a PC keyboard plugged in (or via Remote Desktop), certain key codes on the PC keyboard map to front-panel keys on the GPSA front panel. These key codes are shown below:

Key	Key Code
Frequency	CTRL+SHIFT+F
Span	CTRL+SHIFT+S
Amplitude	CTRL+SHIFT+A
Input/Output	CTRL+SHIFT+O
View/Display	CTRL+SHIFT+V
Trace/Detector	CTRL+ALT+T
Auto Couple	CTRL+SHIFT+C
Bandwidth	CTRL+ALT+B
Source	CTRL+SHIFT+E
Marker	CTRL+SHIFT+K
Peak Search	CTRL+SHIFT+P
Marker To	CTRL+ALT+N
Marker Function	CTRL+ALT+F
System	CTRL+SHIFT+Y
Quick Save	CTRL+SHIFT+Q
Save	CTRL+S
Recall	CTRL+R
Mode Preset	CTRL+M
User Preset	CTRL+U
Print	CTRL+P
File	CTRL+SHIFT+L
Mode	CTRL+SHIFT+M
Measure	CTRL+ALT+M
Mode Setup	CTRL+ALT+E
Meas Setup	CTRL+ALT+U
Trigger	CTRL+SHIFT+T
Sweep/Control	CTRL+SHIFT+W

Key	Key Code
Restart	CTRL+ALT+R
Single	CTRL+ALT+S
Cont	CTRL+ALT+C
Zoom	CTRL+SHIFT+Z
Next Window	CTRL+SHIFT+N
Split Screen	CTRL+L
Full Screen	CTRL+SHIFT+B
Return	CTRL+SHIFT+R
Mute	Mute
Inc Audio	Volume Up
Dec Audio	Volume Down
Help	F1
Control	CTRL
Alt	ALT
Enter	Return
Cancel	Esc
Del	Delete
Backspace	Backspace
Select	Space
Up Arrow	Up
Down Arrow	Down
Left Arrow	Left
Right Arrow	Right
Menu key 1	CTRL+SHIFT+F1
Menu key 2	CTRL+SHIFT+F2
Menu key 3	CTRL+SHIFT+F3
Menu key 4	CTRL+SHIFT+F4
Menu key 5	CTRL+SHIFT+F5
Menu key 6	CTRL+SHIFT+F6
Menu key 7	CTRL+SHIFT+F7

About the Phase Noise Measurement Application

This document provides information on using the Phase Noise Mode in your Agilent Signal Analyzer.

What Does the Phase Noise Application Do?

This analyzer can be used for make single sideband phase noise measurements. The following phase noise measurement can be made with the analyzer:

- Monitor Spectrum
- Log Plot
- Spot Frequency
- IQ Waveform (Time Domain)

The instrument automatically makes these measurements using common measurement methods. The detailed results displayed by the measurements enable you to analyze phase noise performance of a system or device under test (DUT). You may alter the measurement parameters for specialized analysis.

This chapter provides introductory information about the programming documentation included with your product.

What Programming Information is Available?

The X-Series Documentation can be accessed through the Additional Documentation page in the instrument Help system and is included on the Documentation CD shipped with the instrument. It can also be found in the instrument at: C:\ProgramsFiles\Agilent\SignalAnalysis\Infrastructure\Help\otherdocs, or online at: http://www.agilent.com/find/mxa_manuals.

The following resources are available to help you create programs for automating your X-Series measurements:

Resource	Description
X-Series Programmer's Guide	<p>Provides general SCPI programming information on the following topics:</p> <ul style="list-style-type: none">• Programming the X-Series Applications• Programming fundamentals• Programming examples <p>Note that SCPI command descriptions for measurement applications are NOT in this book, but are in the User's and Programmer's Reference.</p>
User's and Programmer's Reference manuals	<p>Describes all front-panel keys and softkeys, including SCPI commands for a measurement application. Note that:</p> <ul style="list-style-type: none">• Each measurement application has its own User's and Programmer's Reference.• The content in this manual is duplicated in the analyzer's Help (the Help that you see for a key is identical to what you see in this manual).
Embedded Help in your instrument	<p>Describes all front-panel keys and softkeys, including SCPI commands, for a measurement application.</p> <p>Note that the content that you see in Help when you press a key is identical to what you see in the User's and Programmer's Reference.</p>
X-Series Getting Started Guide	<p>Provides valuable sections related to programming including:</p> <ul style="list-style-type: none">• Licensing New Measurement Application Software - After Initial Purchase• Configuring instrument LAN Hostname, IP Address, and Gateway Address• Using the Windows XP Remote Desktop to connect to the instrument remotely• Using the Embedded Web Server Telnet connection to communicate SCPI <p>This printed document is shipped with the instrument.</p>
Agilent Application Notes	<p>Printable PDF versions of pertinent application notes.</p>
Agilent VISA User's Guide	<p>Describes the Agilent Virtual Instrument Software Architecture (VISA) library and shows how to use it to develop I/O applications and instrument drivers on Windows PCs.</p>

STATus Subsystem (No equivalent front-panel keys)

The following graphics show the current X-Series Status Register Subsystem implementation.

X-Series Status Byte Register System

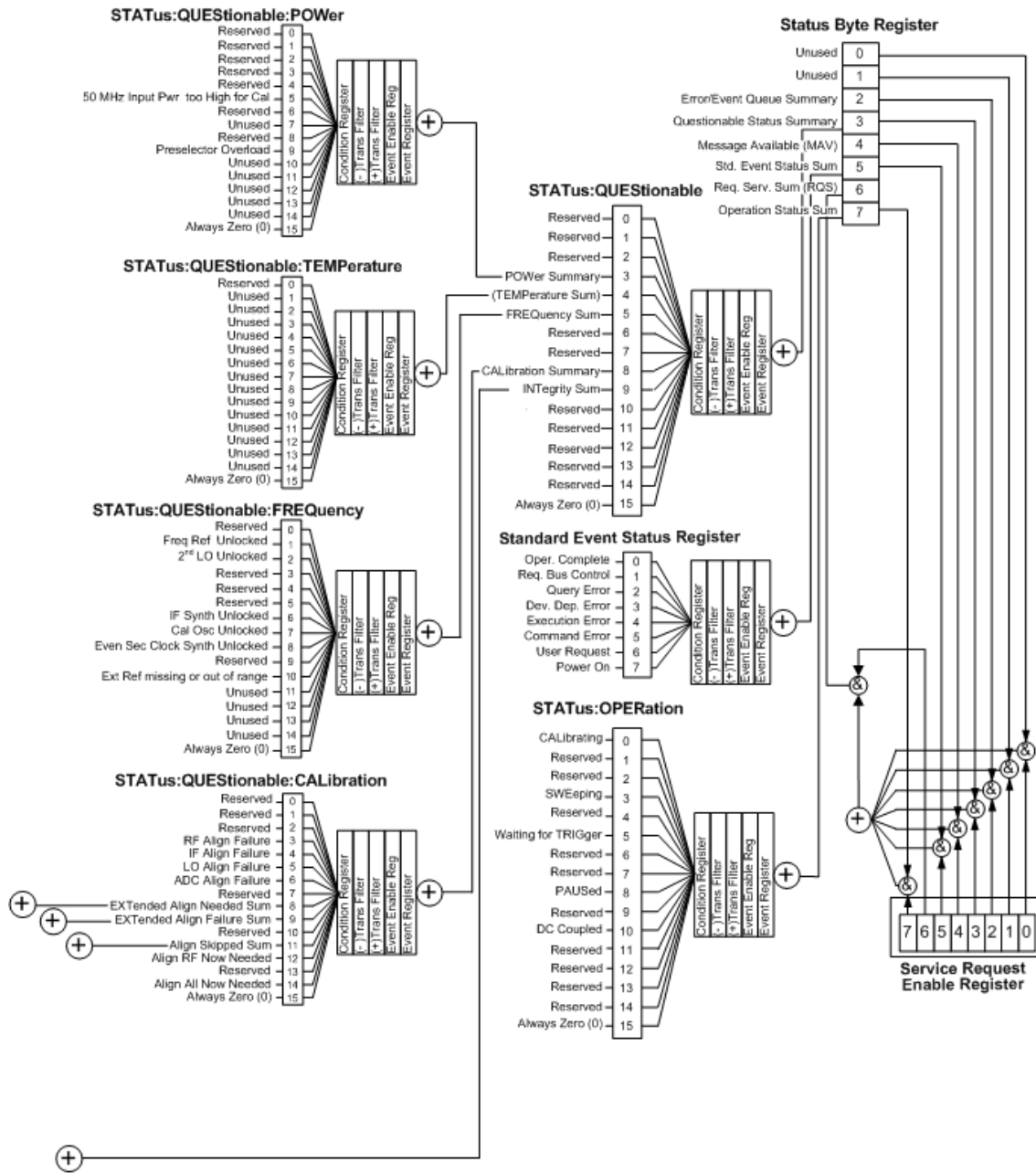

Programming the Analyzer
STATUS Subsystem (No equivalent front-panel keys)

Additional Registers:

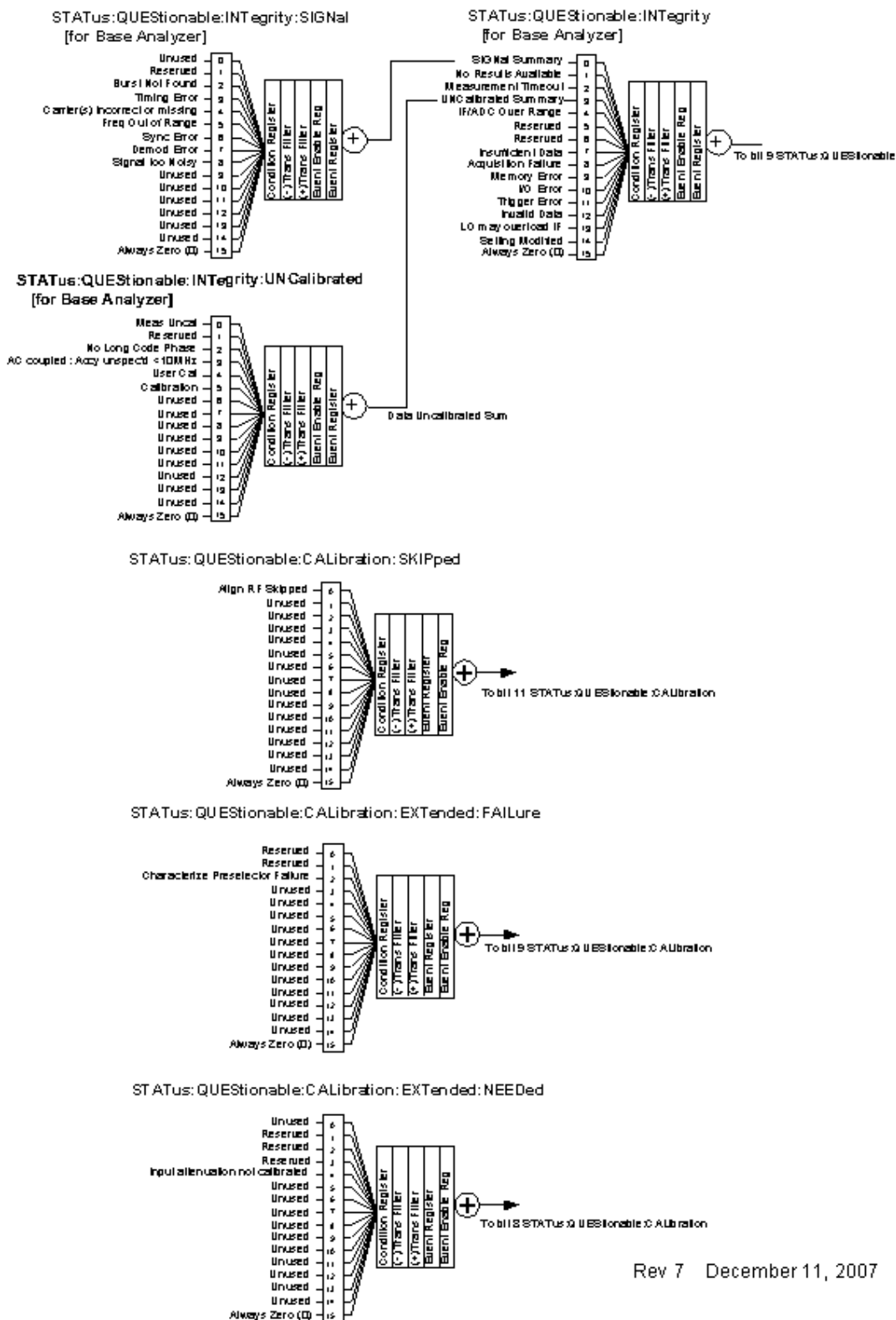

Rev 7 December 11, 2007

Detailed Description

The STATus subsystem remote commands set and query the status hardware registers. This system of registers monitors various events and conditions in the instrument. Software written to control the instrument may need to monitor some of these events and conditions.

All status register commands are sequential. Most commands can be started immediately and will overlap with any existing commands that are already running. This is not true of status commands. All the commands in the spectrum analyzer are assumed to be overlapped unless a command description specifically says that it is sequential.

What Are Status Registers

The status system contains multiple registers that are arranged in a hierarchical order. The lower-level status registers propagate their data to the higher-level registers in the data structures by means of summary bits. The status byte register is at the top of the hierarchy and contains general status information for the instrument's events and conditions. All other individual registers are used to determine the specific events or conditions. For a diagram of the registers and their interconnections, see above.

The operation and questionable status registers are sets of registers that monitor the overall instrument condition. They are accessed with the STATus:OPERation and STATus:QUEStionable commands in the STATus command subsystem. Each register set is made up of five registers:

- Condition Register – It reports the real-time state of the signals monitored by this register set. There is no latching or buffering for a condition register.
- Positive Transition Register – This filter register controls which signals will set a bit in the event register when the signal makes a low to high transition (when the condition bit changes from 0 to 1).
- Negative Transition Register – This filter register controls which signals will set a bit in the event register when the signal makes a high to low transition (when the condition bit changes from 1 to 0).
- Event Register – It latches any signal state changes, in the way specified by the filter registers. Bits in the event register are never cleared by signal state changes. Event registers are cleared when read. They are also cleared by *CLS and by presetting the instrument.
- Event Enable Register – It controls which of the bits, being set in the event register, will be summarized as a single output for the register set. Summary bits are then used by the next higher register.

The STATus:QUEStionable registers report abnormal operating conditions. The status register hierarchy is:

1. The summary outputs from the six STATus:QUEStionable:<keyword> detail registers are inputs to the STATus:QUEStionable register.
2. The summary output from the STATus:QUEStionable register is an input to the Status Byte Register. See the overall system in Figure at the beginning of this section.

The STATus:OPERation register set has no summarized inputs. The inputs to the STATus:OPERation:CONDition register indicate the real time state of the instrument. The STATus:OPERation:EVENt register summary output is an input to the Status Byte Register.

What Are Status Register SCPI Commands

Most monitoring of the instrument conditions is done at the highest level using the IEEE common commands indicated below. Complete command descriptions are available in the IEEE commands section at the beginning of the language reference. Individual status registers can be set and queried using the commands in the STATus subsystem of the language reference.

- *CLS (clear status) clears the status byte by emptying the error queue and clearing all the event registers.
- *ESE, *ESE? (event status enable) sets and queries the bits in the enable register part of the standard event status register.
- *ESR? (event status register) queries and clears the event register part of the standard event status register.
- *OPC, *OPC? (operation complete) sets the standard event status register to monitor the completion of all commands. The query stops any new commands from being processed until the current processing is complete, then returns a '1'.
- *PSC, *PSC? (power-on state clear) sets the power-on state so that it clears the service request enable register and the event status enable register at power on.
- *SRE, *SRE? (service request enable) sets and queries the value of the service request enable register.
- *STB? (status byte) queries the value of the status byte register without erasing its contents.

How to Use the Status Registers

A program often needs to be able to detect and manage error conditions or changes in instrument status. There are two methods you can use to programmatically access the information in status registers:

- The polling method
- The service request (SRQ) method

In the polling method, the instrument has a passive role. It only tells the controller that conditions have changed when the controller asks the right question. In the SRQ method, the instrument takes a more active role. It tells the controller when there has been a condition change without the controller asking. Either method allows you to monitor one or more conditions.

The polling method works well if you do not need to know about changes the moment they occur. The SRQ method should be used if you must know immediately when a condition changes. To detect a change using the polling method, the program must repeatedly read the registers.

Use the SRQ method when:

- you need time-critical notification of changes
- you are monitoring more than one device which supports SRQs
- you need to have the controller do something else while waiting
- you can't afford the performance penalty inherent to polling

Use polling when:

- your programming language/development environment does not support SRQ interrupts
- you want to write a simple, single-purpose program and don't want the added complexity of setting up an SRQ handler
- To monitor a condition:
 1. Determine which register contains the bit that reports the condition.
 2. Send the unique SCPI query that reads that register.
 3. Examine the bit to see if the condition has changed.

You can monitor conditions in different ways.

- Check the current instrument hardware and firmware status.

Do this by querying the condition registers which continuously monitor status. These registers represent the current state of the instrument. Bits in a condition register are updated in real time. When the condition monitored by a particular bit becomes true, the bit is set to 1. When the condition becomes false, the bit is reset to 0.

- Monitor a particular condition (bit).

You can enable a particular bit(s), using the event enable register. The instrument will then monitor that particular condition(s). If the bit becomes true (0 to 1 transition) in the event register, it will stay set until the event register is cleared. Querying the event register allows you to detect that this condition occurred even if the condition no longer exists. The event register can only be cleared by querying it or sending the *CLS command.

- Monitor a particular type of change in a condition (bit).
 - The transition registers are preset to register if the condition goes from 0 to 1 (false to true, or a positive transition).
 - This can be changed so the selected condition is detected if the bit goes from 1 to 0 (true to false, or a negative transition).
 - It can also be set for both types of transitions occurring.
 - Or it can be set for neither transition. If both transition registers are set to 0 for a particular bit position, that bit will not be set in the event register for either type of change.

Using a Status Register

Each bit in a register is represented by a numerical value based on its location. See figure below. This number is sent with the command to enable a particular bit. If you want to enable more than one bit, you would send the sum of all the bits that you want to monitor.

Figure: Status Register Bit Values

Decimal Value																
	32768	16384	8192	4096	2048	1024	512	256	128	64	32	16	8	4	2	1
Bit Number	15	14	13	12	11	10	9	8	7	6	5	4	3	2	1	0

STATus:OPERation:ENABle <num>
 STATus:OPERation:ENABle?

Standard Operation Event Enable Register

ck730a

Bit 15 is not used to report status.

Example 1:

1. To enable bit 0 and bit 6 of standard event status register, send the command *ESE 65 because $1 + 64 = 65$.
2. The results of a query are evaluated in a similar way. If the *STB? command returns a decimal value of 140, ($140 = 128 + 8 + 4$), then bit 7 is true, bit 3 is true and bit 2 is true.

Example 2:

1. Suppose you want to know if an Auto-trigger Timeout occurs, but you only care about that specific condition. For example, you want to know what was happening with bit 10 in the Status Questionable Integrity register, and do not care about any other bits.
2. It's usually a good idea to start by clearing all the status registers with *CLS.
3. Sending the STAT:QUES:INT:ENAB 1024 command enables you to monitor only bit 10 events, instead of the default monitoring all the bits in the register. The register default is for positive transition events (0 to 1 transition) that show when an auto-trigger timeout occurs. If you want to know when the Auto-trigger timeout condition is cleared, set the STAT:QUES:INT:PTR 0 and the STAT:QUES:INT:NTR 32767.
4. So now the only output from the Status Questionable Integrity register will come from a bit 10 positive transition. That output goes to the Integrity Sum bit 9 of the Status Questionable register.
5. You can do a similar thing with this register to look at only bit 9 using, STAT:QUES:ENAB 512.
6. The Status Questionable register output goes to the "Status Questionable Summary" bit 3 of the Status Byte Register. The output from this register can be enabled using the *SRE 8 command.
7. Finally, you can use the serial polling functionality available for the particular bus/software that you are using to monitor the Status Byte Register. (You can also use *STB? to poll the Status Byte Register.)

Using the Service Request (SRQ) Method

Your language, bus, and programming environment must be able to support SRQ interrupts. (For example, BASIC used with VXI-11.3 (GPIB over LAN). When you monitor a condition with the SRQ

method, you must:

1. Determine which bit monitors the condition.
2. Determine how that bit reports to the request service (RQS) bit of the status byte.
3. Send SCPI commands to enable the bit that monitors the condition and to enable the summary bits that report the condition to the RQS bit.
4. Enable the controller to respond to service requests.

When the condition changes, the instrument sets its RQS bit. The controller is informed of the change as soon as it occurs. As a result, the time the controller would otherwise have used to monitor the condition can be used to perform other tasks. Your program determines how the controller responds to the SRQ.

Generating a Service Request

To use the SRQ method, you must understand how service requests are generated. Bit 6 of the status byte register is the request service (RQS) bit. The *SRE command is used to configure the RQS bit to report changes in instrument status. When such a change occurs, the RQS bit is set. It is cleared when the status byte register is queried using *SRE? (with a serial poll.) It can be queried without erasing the contents with *STB?.

When a register set causes a summary bit in the status byte to change from 0 to 1, the instrument can initiate the service request (SRQ) process. However, the process is only initiated if both of the following conditions are true:

- The corresponding bit of the service request enable register is also set to 1.
- The instrument does not have a service request pending. (A service request is considered to be pending between the time the instrument's SRQ process is initiated and the time the controller reads the status byte register.)

The SRQ process sets the SRQ true. It also sets the status byte's request service (RQS) bit to 1. Both actions are necessary to inform the controller that the instrument requires service. Setting the SRQ line only informs the controller that some device on the bus requires service. Setting the RQS bit allows the controller to determine which instrument requires service.

If your program enables the controller to detect and respond to service requests, it should instruct the controller to perform a serial poll when the SRQ is set true. Each device on the bus returns the contents of its status byte register in response to this poll. The device whose RQS bit is set to 1 is the device that requested service.

When you read the instrument's status byte register with a serial poll, the RQS bit is reset to 0. Other bits in the register are not affected.

If the status register is configured to SRQ on end-of-measurement and the measurement is in continuous mode, then restarting a measurement (INIT command) can cause the measuring bit to pulse low. This causes an SRQ when you have not actually reached the "end-of-measurement" condition. To avoid this:

1. Set INITiate:CONTinuous off.
2. Set/enable the status registers.
3. Restart the measurement (send INIT).

Status Register System

The hardware status registers are combined to form the instrument status system. Specific status bits are assigned to monitor various aspects of the instrument operation and status. See the diagram of the status system above for information about the bit assignments and status register interconnections.

The Status Byte Register

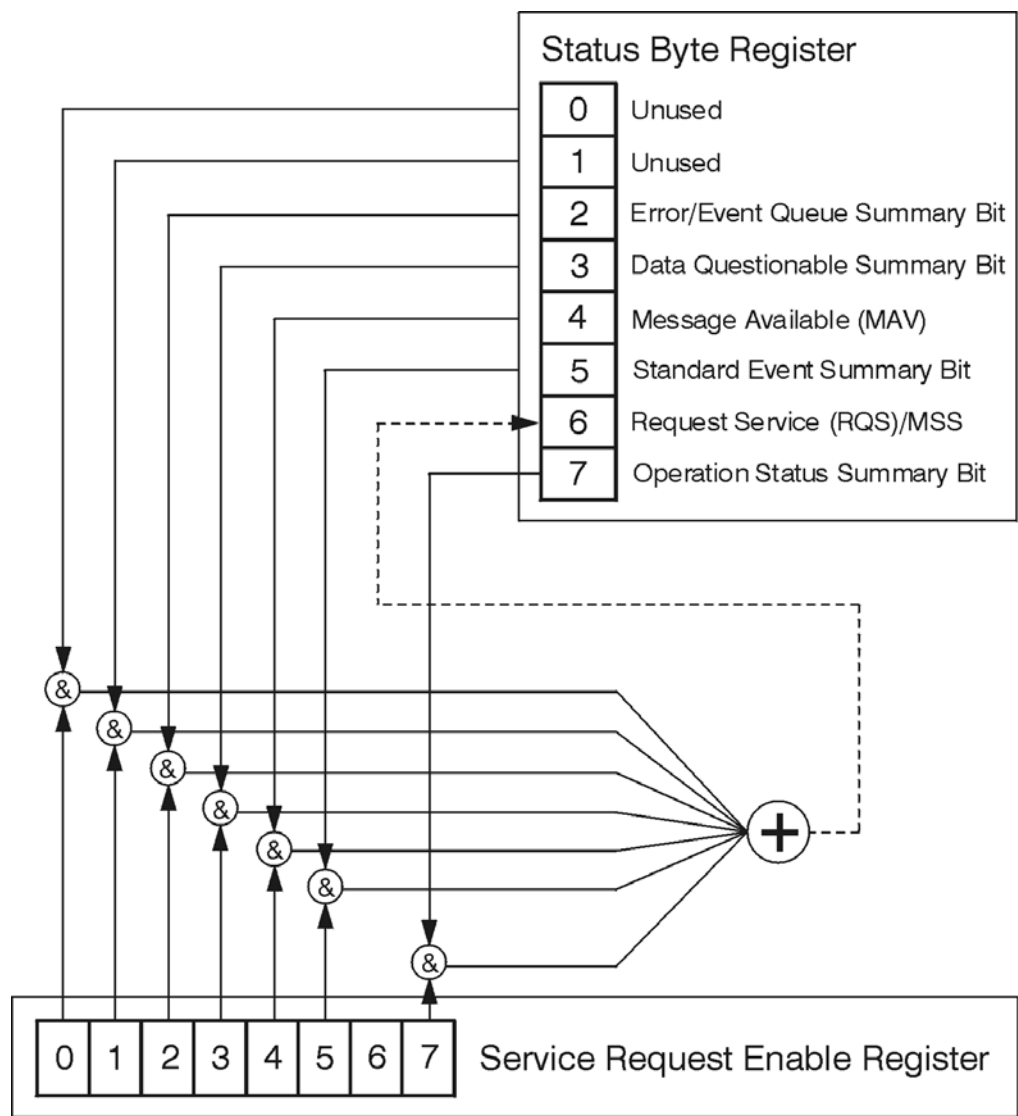

ck776a

The RQS bit is read and reset by a serial poll. The same bit position (MSS) is read, non-destructively by the *STB? command. If you serial poll bit 6 it is read as RQS, but if you send *STB it reads bit 6 as MSS. For more information refer to IEEE 488.2 standards, section 11.

Bit Number	7	6	5	4	3	2	1	0
	Standard Operation Status Summary Bit	Request Service (RQS) Summary Bit	Standard Event Status Summary Bit	Message Available (MAV)	Data Questionable Status Summary Bit	Error/Event Queue Summary Bit	Unused	Unused

*STB?

Status Byte Register

ck725a

Bit	Description
0, 1	These bits are always set to 0.
2	A 1 in this bit position indicates that the SCPI error queue is not empty which means that it contains at least one error message.
3	A 1 in this bit position indicates that the data questionable summary bit has been set. The data questionable event register can then be read to determine the specific condition that caused this bit to be set.
4	A 1 in this bit position indicates that the instrument has data ready in the output queue. There are no lower status groups that provide input to this bit.
5	A 1 in this bit position indicates that the standard event summary bit has been set. The standard event status register can then be read to determine the specific event that caused this bit to be set.
6	A 1 in this bit position indicates that the instrument has at least one reason to report a status change. This bit is also called the master summary status bit (MSS).
7	A 1 in this bit position indicates that the standard operation summary bit has been set. The standard operation event register can then be read to determine the specific condition that caused this bit to be set.

To query the status byte register, send the command *STB?. The response will be the decimal sum of the bits which are set to 1. For example, if bit number 7 and bit number 3 are set to 1, the decimal sum of the 2 bits is 128 plus 8. So the decimal value 136 is returned. The *STB command does not clear the status register.

In addition to the status byte register, the status byte group also contains the service request enable register. This register lets you choose which bits in the status byte register will trigger a service request.

Send the *SRE <integer> command where <integer> is the sum of the decimal values of the bits you want to enable plus the decimal value of bit 6. For example, assume that you want to enable bit 7 so that whenever the standard operation status register summary bit is set to 1 it will trigger a service request. Send the command *SRE 192 (because $192 = 128 + 64$). You must always add 64 (the numeric value of

Programming the Analyzer
STATUS Subsystem (No equivalent front-panel keys)

RQS bit 6) to your numeric sum when you enable any bits for a service request. The command *SRE? returns the decimal value of the sum of the bits previously enabled with the *SRE <integer> command.

The service request enable register presets to zeros (0).

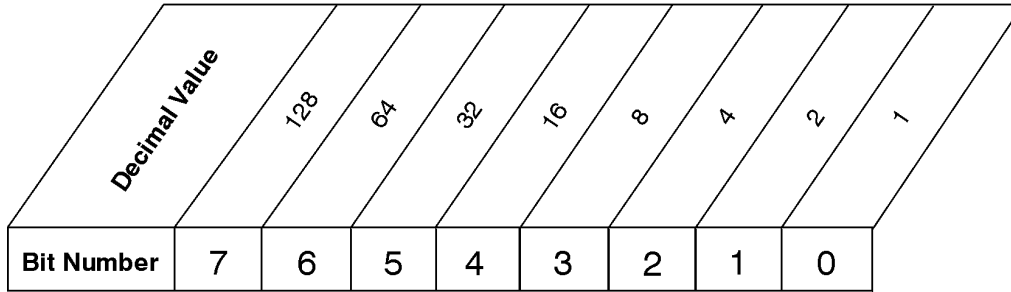

*SRE <num>
 *SRE?

Service Request Enable Register

ck726a

Standard Event Status Register

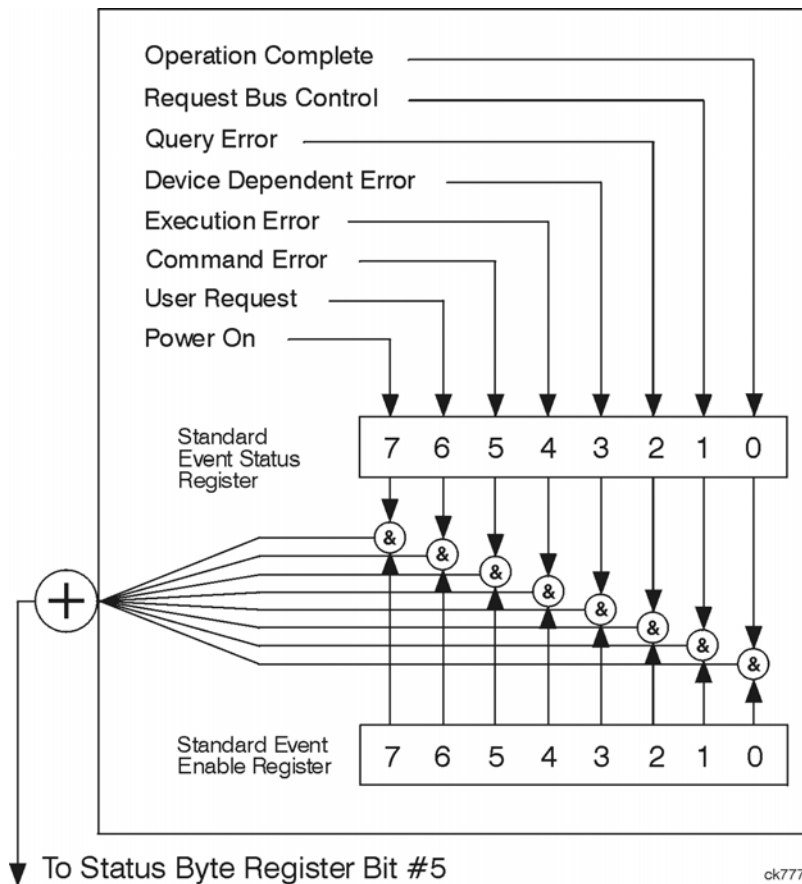

The standard event status register contains the following bits:

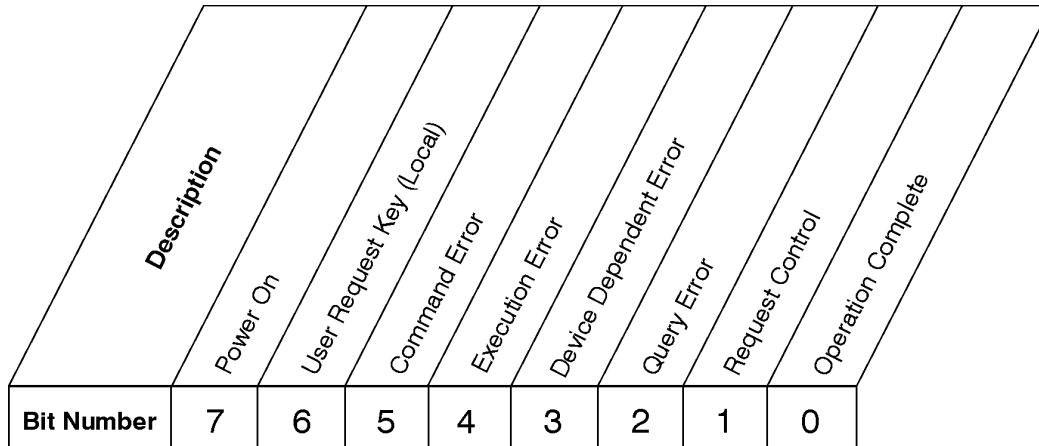

*ESR?

Standard Event Status Register

ck727a

Bit	Description
0	A 1 in this bit position indicates that all pending operations were completed following execution of the *OPC command.
1	This bit is for GPIB handshaking to request control. Currently it is set to 0 because there are no implementations where the spectrum analyzer controls another instrument.
2	A 1 in this bit position indicates that a query error has occurred. Query errors have SCPI error numbers from -499 to -400.
3	A 1 in this bit position indicates that a device dependent error has occurred. Device dependent errors have SCPI error numbers from -399 to -300 and 1 to 32767.
4	A 1 in this bit position indicates that an execution error has occurred. Execution errors have SCPI error numbers from -299 to -200.
5	A 1 in this bit position indicates that a command error has occurred. Command errors have SCPI error numbers from -199 to -100.
6	A 1 in this bit position indicates that the LOCAL key has been pressed. This is true even if the instrument is in local lockout mode.
7	A 1 in this bit position indicates that the instrument has been turned off and then on.

The standard event status register is used to determine the specific event that set bit 5 in the status byte register. To query the standard event status register, send the command *ESR?. The response will be the decimal sum of the bits which are enabled (set to 1). For example, if bit number 7 and bit number 3 are enabled, the decimal sum of the 2 bits is 128 plus 8. So the decimal value 136 is returned.

In addition to the standard event status register, the standard event status group also contains a standard event status enable register. This register lets you choose which bits in the standard event status register will set the summary bit (bit 5 of the status byte register) to 1. Send the *ESE <integer> command where <integer> is the sum of the decimal values of the bits you want to enable. For example, to enable bit 7

Programming the Analyzer
STATus Subsystem (No equivalent front-panel keys)

and bit 6 so that whenever either of those bits is set to 1, the standard event status summary bit of the status byte register will be set to 1, send the command *ESE 192 (128 + 64). The command *ESE? returns the decimal value of the sum of the bits previously enabled with the *ESE <integer> command.

The standard event status enable register presets to zeros (0).

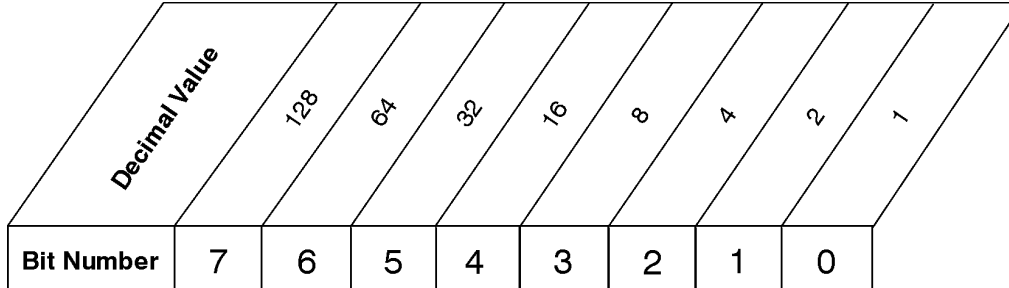

*ESE <num>
 *ESE?

Standard Event Status Enable Register

ck728a

Operation and Questionable Status Registers

The operation and questionable status registers are registers that monitor the overall instrument condition. They are accessed with the STATus:OPERation and STATus:QUESTionable commands in the STATus command subsystem. See the figure at the beginning of this chapter.

Operation Status Register

The operation status register monitors the current instrument measurement state. It checks to see if the instrument is calibrating, sweeping, or waiting for a trigger. For more information see the *OPC? command located in the IEEE Common Commands section.

Bit	Condition	Operation
0	Calibrating	The instrument is busy executing its Align Now process
3	Sweeping	The instrument is busy taking a sweep.
4	Measuring	The instrument is busy making a measurement. Measurements often require multiple sweeps. They are initiated by keys under the MEASURE key or with the MEASure group of commands. The bit is valid for most X-Series Modes.
5	Waiting for trigger	The instrument is waiting for the trigger conditions to be met, then it will trigger a sweep or measurement.
8	Paused	The instrument is paused (waiting) because you have pressed the Pause Meas Control key or send the INITiate:PAUSE command. Bit is currently only valid for Modes: ESA/PSA: Spectrum Analysis, Phase Noise, and ESA: Bluetooth, cdmaOne, GSM

Questionable Status Register

The questionable status register monitors the instrument's condition to see if anything questionable has

happened to it. It is looking for anything that might cause an error or a bad measurement like a hardware problem, an out of calibration situation, or a unusual signal. All the bits are summary bits from lower-level event registers.

Bit	Condition	Operation
3	Power summary	The instrument hardware has detected a power unlevelled condition.
4	Temperature summary	The instrument is still warming up.
5	Frequency summary	The instrument hardware has detected an unlocked condition or a problem with the external frequency reference.
8	Calibration summary	The instrument has detected a hardware problem while doing the automatic internal alignment process.
9	Integrity summary	The instrument has detected a questionable measurement condition such as: bad timing, bad signal/data, timeout problem, signal overload, or “meas uncal”.

STATus Subsystem Command Descriptions

The STATus subsystem controls the SCPI-defined instrument status reporting structures. Each status register has a set of five commands used for querying or masking that particular register.

Numeric values for bit patterns can be entered using decimal or hexadecimal representations. (i.e. 0 to 32767 is equivalent to #H0 to #H7FFF. It is also equal to all ones, 11111111111111) See the SCPI Basics information about using bit patterns for variable parameters.

Operation Register

Operation Condition Query

This query returns the decimal value of the sum of the bits in the Status Operation Condition register.

NOTE The data in this register is continuously updated and reflects the current conditions.

Mode	All
Remote Command	:STATus:OPERation:CONDition?
Example	STAT:OPER:COND?
Preset	0
SCPI Status Bits/OPC Dependencies	Sequential command
Instrument S/W Revision	Prior to A.02.00

Operation Enable

This command determines which bits in the Operation Event register, will set the Operation Status Summary bit (bit 7) in the Status Byte Register. The variable <integer> is the sum of the decimal values of the bits you want to enable.

NOTE The preset condition is to have all bits in this enable register set to 0. To have any Operation Events reported to the Status Byte Register, one or more bits need to be set to 1.

Mode	All
Remote Command	:STATus:OPERation:ENABle <integer> :STATus:OPERation:ENABle?
Example	STAT:OPER:ENAB 1 Sets the register so that Align Now operation will be reported to the Status Byte Register.
Preset	0
SCPI Status Bits/OPC Dependencies	Sequential command
Min	0
Max	32767
Instrument S/W Revision	Prior to A.02.00

Operation Event Query

This query returns the decimal value of the sum of the bits in the Operation Event register.

NOTE The register requires that the associated PTR or NTR filters be set before a condition register bit can set a bit in the event register. The data in this register is latched until it is queried. Once queried, the register is cleared.

Mode	All
Remote Command	:STATus:OPERation[:EVENT]?
Example	STAT:OPER?
Preset	0
SCPI Status Bits/OPC Dependencies	Sequential command
Instrument S/W Revision	Prior to A.02.00

Operation Negative Transition

This command determines which bits in the Operation Condition register will set the corresponding bit in the Operation Event register when the condition register bit has a negative transition (1 to 0). The variable <integer> is the sum of the decimal values of the bits that you want to enable.

Mode	All
Remote Command	:STATus:OPERation:NTRansition <integer> :STATus:OPERation:NTRansition?
Example	STAT:OPER:NTR 1 Align Now operation complete will be reported to the Status Byte Register.
Preset	0
SCPI Status Bits/OPC Dependencies	Sequential command
Min	0
Max	32767
Instrument S/W Revision	Prior to A.02.00

Operation Positive Transition

This command determines which bits in the Operation Condition register will set the corresponding bit in the Operation Event register when the condition register bit has a positive transition (0 to 1). The variable <integer> is the sum of the decimal values of the bits that you want to enable.

Mode	All
Remote Command	:STATus:OPERation:PTRansition <integer> :STATus:OPERation:PTRansition?
Example	STAT:OPER:PTR 1 Align Now operation beginning will be reported to the Status Byte Register.
Preset	32767
SCPI Status Bits/OPC Dependencies	Sequential command
Min	0
Max	32767
Instrument S/W Revision	Prior to A.02.00

Preset the Status Byte

Sets bits in most of the enable and transition registers to their default state. It presets all the Transition Filters, Enable Registers, and the Error/Event Queue Enable. It has no effect on Event Registers, Error/Event QUEue, IEEE 488.2 ESE, and SRE Registers as described in IEEE Standard 488.2–1992, IEEE Standard Codes, Formats, Protocols, and Common Commands for Use with ANSI/IEEE Std 488.1–1987. New York, NY, 1992.

Remote Command: : STATus: PRESet
 Example: STAT: PRES
 Instrument S/W Revision: Prior to A.02.00

Questionable Register

Questionable Condition

This query returns the decimal value of the sum of the bits in the Questionable Condition register.

NOTE The data in this register is continuously updated and reflects the current conditions.

Mode All
 Remote Command : STATus: QUEStionable: CONDition?
 Example STAT: QUES: COND?
 Preset 0
 SCPI Status Bits/OPC
 Dependencies Sequential command
 Instrument S/W Revision Prior to A.02.00

Questionable Enable

This command determines which bits in the Questionable Event register will set the Questionable Status Summary bit (bit3) in the Status Byte Register. The variable <integer> is the sum of the decimal values of the bits you want to enable.

NOTE The preset condition is all bits in this enable register set to 0. To have any Questionable Events reported to the Status Byte Register, one or more bits need to be set to 1. The Status Byte Event Register should be queried after each measurement to check the Questionable Status Summary (bit 3). If it is equal to 1, a condition during the test may have made the test results invalid. If it is equal to 0, this indicates that no hardware problem or measurement problem was detected by the analyzer.

Mode All

Remote Command	:STATus:QUESTionable:ENABle 16 Sets the register so that temperature summary will be reported to the Status Byte Register :STATus:QUESTionable:ENABle?
Example	STAT:OPER:PTR 1 Align Now operation beginning will be reported to the Status Byte Register.
Preset	0
SCPI Status Bits/OPC Dependencies	Sequential command
Min	0
Max	32767
Instrument S/W Revision	Prior to A.02.00

Questionable Event Query

This query returns the decimal value of the sum of the bits in the Questionable Event register.

NOTE The register requires that the associated PTR or NTR filters be set before a condition register bit can set a bit in the event register. The data in this register is latched until it is queried. Once queried, the register is cleared.

Mode	All
Remote Command	:STATus:QUESTionable[:EVENT]?
Example	STAT:QUES?
Preset	0
SCPI Status Bits/OPC Dependencies	Sequential command
Instrument S/W Revision	Prior to A.02.00

Questionable Negative Transition

This command determines which bits in the Questionable Condition register will set the corresponding bit in the Questionable Event register when the condition register bit has a negative transition (1 to 0). The variable <integer> is the sum of the decimal values of the bits that you want to enable.

Mode	All
Remote Command	:STATus:QUESTionable:NTRansition 16 Temperature summary 'questionable cleared' will be reported to the Status Byte Register. :STATus:QUESTionable:NTRansition?

Programming the Analyzer

STATus Subsystem (No equivalent front-panel keys)

Example	STAT:QUES:NTR 16 Temperature summary 'questionable cleared' will be reported to the Status Byte Register.
Preset	0
SCPI Status Bits/OPC Dependencies	Sequential command
Min	0
Max	32767
Instrument S/W Revision	Prior to A.02.00

Questionable Positive Transition

This command determines which bits in the Questionable Condition register will set the corresponding bit in the Questionable Event register when the condition register bit has a positive transition (0 to 1). The variable <integer> is the sum of the decimal values of the bits that you want to enable.

Mode	All
Remote Command	:STATus:QUESTionable:PTRansition <integer> :STATus:QUESTionable:PTRansition?
Example	STAT:QUES:PTR 16 Temperature summary 'questionable asserted' will be reported to the Status Byte Register.
Preset	32767
SCPI Status Bits/OPC Dependencies	Sequential command
Min	0
Max	32767
Instrument S/W Revision	Prior to A.02.00

Questionable Calibration Register

Questionable Calibration Condition

This query returns the decimal value of the sum of the bits in the Questionable Calibration Condition register.

NOTE The data in this register is continuously updated and reflects the current conditions.

Mode	All
Remote Command	:STATus:QUESTionable:CALibration:CONDition?
Example	STAT:QUES:CAL:COND?

Preset	0
SCPI Status Bits/OPC Dependencies	Sequential command
Instrument S/W Revision	Prior to A.02.00

Questionable Calibration Enable

This command determines which bits in the Questionable Calibration Condition Register will set bits in the Questionable Calibration Event register, which also sets the Calibration Summary bit (bit 8) in the Questionable Register. The variable <integer> is the sum of the decimal values of the bits you want to enable.

Mode	All
Remote Command	:STATus:QUESTionable:CALibration:ENABLE <integer> :STATus:QUESTionable:CALibration:ENABLE?
Example	STAT:QUES:CAL:ENAB 16384 Can be used to query if an alignment is needed, if you have turned off the automatic alignment process.
SCPI Status Bits/OPC Dependencies	Sequential command
Min	0
Max	32767
Instrument S/W Revision	Prior to A.02.00

Questionable Calibration Event Query

This query returns the decimal value of the sum of the bits in the Questionable Calibration Event register.

NOTE The register requires that the associated PTR or NTR filters be set before a condition register bit can set a bit in the event register. The data in this register is latched until it is queried. Once queried, the register is cleared.

Mode	All
Remote Command	:STATus:QUESTionable:CALibration[:EVENT]?
Example	STAT:QUES:CAL?
Preset	0
SCPI Status Bits/OPC Dependencies	Sequential command
Instrument S/W Revision	Prior to A.02.00

Questionable Calibration Negative Transition

This command determines which bits in the Questionable Calibration Condition register will set the corresponding bit in the Questionable Calibration Event register when the condition register bit has a negative transition (1 to 0). The variable <integer> is the sum of the decimal values of the bits that you want to enable.

Mode	All
Remote Command	:STATus:QUESTionable:CALibration:NTRansition <integer> :STATus:QUESTionable:CALibration:NTRansition?
Example	STAT:QUES:CAL:NTR 16384 Alignment is not required.
Preset	0
SCPI Status Bits/OPC Dependencies	Sequential command
Min	0
Max	32767
Instrument S/W Revision	Prior to A.02.00

Questionable Calibration Positive Transition

This command determines which bits in the Questionable Calibration Condition register will set the corresponding bit in the Questionable Calibration Event register when the condition register bit has a positive transition (0 to 1). The variable <integer> is the sum of the decimal values of the bits that you want to enable.

Mode	All
Remote Command	:STATus:QUESTionable:CALibration:PTRansition <integer> :STATus:QUESTionable:CALibration:PTRansition?
Example	STAT:QUES:CAL:PTR 16384 Alignment is required.
Preset	32767
SCPI Status Bits/OPC Dependencies	Sequential command
Min	0
Max	32767
Instrument S/W Revision	Prior to A.02.00

Questionable Calibration Skipped Register

Questionable Calibration Skipped Condition

This query returns the decimal value of the sum of the bits in the Questionable Calibration Skipped Condition register.

NOTE The data in this register is continuously updated and reflects the current conditions.

Mode	All
Remote Command	:STATus:QUESTionable:CALibration:SKIpped:CONDition?
Example	STAT:QUES:CAL:SKIP:COND?
Preset	0
SCPI Status Bits/OPC Dependencies	Sequential command
Instrument S/W Revision	Prior to A.02.00

Questionable Calibration Skipped Enable

This command determines which bits in the Questionable Calibration Skipped Condition Register will set bits in the Questionable Calibration Skipped Event register, which also sets bit 11 of the Questionable Calibration Register. The variable <integer> is the sum of the decimal values of the bits you want to enable.

Mode	All
Remote Command	:STATus:QUESTionable:CALibration:SKIpped:ENABle <integer> :STATus:QUESTionable:CALibration:SKIpped:ENABle?
Example	STAT:QUES:CAL:SKIP:ENAB 1 Can be used to query if an EMI alignment skipped condition is detected
Preset	32767
SCPI Status Bits/OPC Dependencies	Sequential command
Min	0
Max	32767
Instrument S/W Revision	Prior to A.02.00

Questionable Calibration Skipped Event Query

This query returns the decimal value of the sum of the bits in the Questionable Calibration Event register.

NOTE The register requires that the associated PTR or NTR filters be set before a condition register bit can set a bit in the event register. The data in this register is latched until it is queried. Once queried, the register is cleared.

Mode	All
------	-----

Programming the Analyzer

STATus Subsystem (No equivalent front-panel keys)

Remote Command	:STATus:QUESTionable:CALibration:SKIpped[:EVENT]?
Example	STAT:QUES:CAL:SKIP?
Preset	0
SCPI Status Bits/OPC	Sequential command
Dependencies	
Instrument S/W Revision	Prior to A.02.00

Questionable Calibration Skipped Negative Transition

This command determines which bits in the Questionable Calibration Skipped Condition register will set the corresponding bit in the Questionable Calibration Skipped Event register when the condition register bit has a negative transition (1 to 0). The variable <integer> is the sum of the decimal values of the bits that you want to enable.

Mode	All
Remote Command	:STATus:QUESTionable:CALibration:SKIpped:NTRansition <integer> :STATus:QUESTionable:CALibration:SKIpped:NTRansition?
Example	STAT:QUES:CAL:SKIP:NTR 1 Align RF skipped is not required.
Preset	0
SCPI Status Bits/OPC	Sequential command
Dependencies	
Min	0
Max	32767
Instrument S/W Revision	Prior to A.02.00

Questionable Calibration Skipped Positive Transition

This command determines which bits in the Questionable Calibration Skipped Condition register will set the corresponding bit in the Questionable Calibration Skipped Event register when the condition register bit has a positive transition (0 to 1). The variable <integer> is the sum of the decimal values of the bits that you want to enable.

Mode	All
Remote Command	:STATus:QUESTionable:CALibration:SKIpped:PTRansition <integer> :STATus:QUESTionable:CALibration:SKIpped:PTRansition?
Example	STAT:QUES:CAL:SKIP:PTR 1 Align RF skipped is required.
Preset	32767

SCPI Status Bits/OPC Dependencies	Sequential command
Min	0
Max	32767
Instrument S/W Revision	Prior to A.02.00

Questionable Calibration Extended Failure Register

Questionable Calibration Extended Failure Condition

This query returns the decimal value of the sum of the bits in the Questionable Calibration Extended Failure Condition register.

NOTE The data in this register is continuously updated and reflects the current conditions.

Mode	All
Remote Command	:STATus:QUESTionable:CALibration:EXTended:FAILure:CONDition?
Example	STAT:QUES:CAL:EXT:FAIL:COND?
Preset	0
SCPI Status Bits/OPC Dependencies	Sequential command
Instrument S/W Revision	Prior to A.02.00

Questionable Calibration Extended Failure Enable

This command determines which bits in the Questionable Calibration Extended Failure Condition Register will set bits in the Questionable Calibration Extended Failure Event register, which also sets bit 9 of the Questionable Calibration Register. The variable <integer> is the sum of the decimal values of the bits you want to enable.

Mode	All
Remote Command	:STATus:QUESTionable:CALibration:EXTended:FAILure:ENABle <integer> :STATus:QUESTionable:CALibration:EXTended:FAILure:ENABle?
Example	STAT:QUES:CAL:EXT:FAIL:ENAB 1 Can be used to query if an EMI conducted alignment is needed.
Preset	32767
SCPI Status Bits/OPC Dependencies	Sequential command

Programming the Analyzer
STATus Subsystem (No equivalent front-panel keys)

Min	0
Max	32767
Instrument S/W Revision	Prior to A.02.00

Questionable Calibration Extended Failure Event Query

This query returns the decimal value of the sum of the bits in the Questionable Calibration Extended Failure Event register.

NOTE The register requires that the associated PTR or NTR filters be set before a condition register bit can set a bit in the event register. The data in this register is latched until it is queried. Once queried, the register is cleared.

Mode	All
Remote Command	:STATus:QUESTionable:CALibration:EXTended:FAILure[:EVENt]?
Example	STAT:QUES:CAL:EXT:FAIL?
Preset	0
SCPI Status Bits/OPC Dependencies	Sequential command
Instrument S/W Revision	Prior to A.02.00

Questionable Calibration Extended Failure Negative Transition

This command determines which bits in the Questionable Calibration Extended Failure Condition register will set the corresponding bit in the Questionable Calibration Extended Failure Event register when the condition register bit has a negative transition (1 to 0). The variable <integer> is the sum of the decimal values of the bits that you want to enable.

Mode	All
Remote Command	:STATus:QUESTionable:CALibration:EXTended:FAILure:NTRan sition <integer> :STATus:QUESTionable:CALibration:EXTended:FAILure:NTRan sition?
Example	STAT:QUES:CAL:EXT:FAIL:NTR 1 EMI conducted align failure is not required.
Preset	0
SCPI Status Bits/OPC Dependencies	Sequential command
Min	0

Max 32767
 Instrument S/W Revision Prior to A.02.00

Questionable Calibration Extended Failure Positive Transition

This command determines which bits in the Questionable Calibration Extended Failure Condition register will set the corresponding bit in the Questionable Calibration Extended Failure Event register when the condition register bit has a positive transition (0 to 1). The variable <integer> is the sum of the decimal values of the bits that you want to enable.

Mode All
 Remote Command :STATus:QUESTionable:CALibration:EXTended:FAILure:PTRan
 sition <integer>
 :STATus:QUESTionable:CALibration:EXTended:FAILure:PTRan
 sition?
 Example STAT:QUES:CAL:EXT:FAIL:PTR 1 EMI conducted align failure is required.
 Preset 32767
 SCPI Status Bits/OPC Sequential command
 Dependencies
 Min 0
 Max 32767
 Instrument S/W Revision Prior to A.02.00

Questionable Calibration Extended Needed Register

Questionable Calibration Extended Needed Condition

This query returns the decimal value of the sum of the bits in the Questionable Calibration Extended Needed Condition register.

NOTE The data in this register is continuously updated and reflects the current conditions.

Mode All
 Remote Command :STATus:QUESTionable:CALibration:EXTended:NEEDed:CONDit
 ion?
 Example STAT:QUES:CAL:EXT:NEED:COND?
 Preset 0
 SCPI Status Bits/OPC Sequential command
 Dependencies
 Instrument S/W Revision Prior to A.02.00

Questionable Calibration Extended Needed Enable

This command determines which bits in the Questionable Calibration Extended Needed Condition Register will set bits in the Questionable Calibration Extended Needed Event register, which also sets bit 14 of the Questionable Calibration Register. The variable <integer> is the sum of the decimal values of the bits you want to enable.

Mode	All
Remote Command	:STATus:QUESTionable:CALibration:EXTended:NEEDED:ENABle <integer> :STATus:QUESTionable:CALibration:EXTended:NEEDED:ENABle ?
Example	STAT:QUES:CAL:EXT:NEED:ENAB 2 Can be used to query if an EMI conducted alignment is needed.
Preset	32767
SCPI Status Bits/OPC Dependencies	Sequential command
Min	0
Max	32767
Instrument S/W Revision	Prior to A.02.00

Questionable Calibration Extended Needed Event Query

This query returns the decimal value of the sum of the bits in the Questionable Calibration Extended Needed Event register.

NOTE The register requires that the associated PTR or NTR filters be set before a condition register bit can set a bit in the event register. The data in this register is latched until it is queried. Once queried, the register is cleared.

Mode	All
Remote Command	:STATus:QUESTionable:CALibration:EXTended:NEEDED[:EVENT]?
Example	STAT:QUES:CAL:EXT:NEED?
Preset	0
SCPI Status Bits/OPC Dependencies	Sequential command
Instrument S/W Revision	Prior to A.02.00

Questionable Calibration Extended Needed Negative Transition

This command determines which bits in the Questionable Calibration Extended Needed Condition register will set the corresponding bit in the Questionable Calibration Extended Needed Event register when the condition register bit has a negative transition (1 to 0). The variable <integer> is the sum of the decimal values of the bits that you want to enable.

Mode	All
Remote Command	:STATus:QUESTionable:CALibration:EXTended:NEEDED:NTRansition <integer> :STATus:QUESTionable:CALibration:EXTended:NEEDED:NTRansition?
Example	STAT:QUES:CAL:EXT:NEED:NTR 2 Align EMI conducted is not required.
Preset	0
SCPI Status Bits/OPC Dependencies	Sequential command
Min	0
Max	32767
Instrument S/W Revision	Prior to A.02.00

Questionable Calibration Extended Needed Positive Transition

This command determines which bits in the Questionable Calibration Extended Needed Condition register will set the corresponding bit in the Questionable Calibration Extended Needed Event register when the condition register bit has a positive transition (0 to 1). The variable <integer> is the sum of the decimal values of the bits that you want to enable.

Mode	All
Remote Command	:STATus:QUESTionable:CALibration:EXTended:NEEDED:PTRansition <integer> :STATus:QUESTionable:CALibration:EXTended:NEEDED:PTRansition?
Example	STAT:QUES:CAL:EXT:NEED:PTR 2 Align EMI conducted is required.
Preset	32767
SCPI Status Bits/OPC Dependencies	Sequential command
Min	0
Max	32767
Instrument S/W Revision	Prior to A.02.00

Questionable Frequency Register

Questionable Frequency Condition

This query returns the decimal value of the sum of the bits in the Questionable Frequency Condition register.

NOTE The data in this register is continuously updated and reflects the current conditions.

Mode	All
Remote Command	:STATus:QUESTionable:FREQuency:CONDition?
Example	STAT:QUES:FREQ:COND?
Preset	0
SCPI Status Bits/OPC Dependencies	Sequential command
Instrument S/W Revision	Prior to A.02.00

Questionable Frequency Enable

This command determines which bits in the Questionable Frequency Condition Register will set bits in the Questionable Frequency Event register, which also sets the Frequency Summary bit (bit 5) in the Questionable Register. The variable <integer> is the sum of the decimal values of the bits you want to enable.

Mode	All
Remote Command	:STATus:QUESTionable:FREQuency:ENABle <integer> :STATus:QUESTionable:FREQuency:ENABle?
Example	STAT:QUES:FREQ:ENAB 2 Frequency Reference Unlocked will be reported to the Frequency Summary of the Status Questionable register.
Preset	32767
SCPI Status Bits/OPC Dependencies	Sequential command
Min	0
Max	32767
Instrument S/W Revision	Prior to A.02.00

Questionable Frequency Event Query

This query returns the decimal value of the sum of the bits in the Questionable Frequency Event register.

NOTE The register requires that the associated PTR or NTR filters be set before a condition register bit can set a bit in the event register. The data in this register is latched until it is queried. Once queried, the register is cleared.

Mode	All
Remote Command	:STATus:QUESTionable:FREQuency[:EVENT]?
Example	STAT:QUES:FREQ?
Preset	0
SCPI Status Bits/OPC Dependencies	Sequential command
Instrument S/W Revision	Prior to A.02.00

Questionable Frequency Negative Transition

This command determines which bits in the Questionable Frequency Condition register will set the corresponding bit in the Questionable Frequency Event register when the condition register bit has a negative transition (1 to 0). The variable <integer> is the sum of the decimal values of the bits that you want to enable.

Mode	All
Remote Command	:STATus:QUESTionable:FREQuency:NTRansition <integer> :STATus:QUESTionable:FREQuency:NTRansition?
Example	STAT:QUES:FREQ:NTR 2 Frequency Reference 'regained lock' will be reported to the Frequency Summary of the Status Questionable register.
Preset	0
SCPI Status Bits/OPC Dependencies	Sequential command
Min	0
Max	32767
Instrument S/W Revision	Prior to A.02.00

Questionable Frequency Positive Transition

This command determines which bits in the Questionable Frequency Condition register will set the corresponding bit in the Questionable Frequency Event register when the condition register bit has a positive transition (0 to 1). The variable <integer> is the sum of the decimal values of the bits that you want to enable.

Mode	All
Remote Command	:STATus:QUESTionable:FREQuency:PTRansition <integer> :STATus:QUESTionable:FREQuency:PTRansition?
Example	STAT:QUES:FREQ:PTR 2 Frequency Reference 'became unlocked' will be reported to the Frequency Summary of the Status Questionable register.
Preset	32767
SCPI Status Bits/OPC Dependencies	Sequential command
Min	0
Max	32767
Instrument S/W Revision	Prior to A.02.00

Questionable Integrity Register

Questionable Integrity Condition

This query returns the decimal value of the sum of the bits in the Questionable Integrity Condition register.

NOTE The data in this register is continuously updated and reflects the current conditions.

Mode	All
Remote Command	:STATus:QUESTionable:INTEgrity:CONDition?
Example	STAT:QUES:INT:COND?
Preset	0
SCPI Status Bits/OPC Dependencies	Sequential command
Instrument S/W Revision	Prior to A.02.00

Questionable Integrity Enable

This command determines which bits in the Questionable Integrity Condition Register will set bits in the Questionable Integrity Event register, which also sets the Integrity Summary bit (bit 9) in the Questionable Register. The variable <integer> is the sum of the decimal values of the bits you want to enable.

Mode	All
Remote Command	:STATus:QUESTionable:INTEgrity:ENABle <integer> :STATus:QUESTionable:INTEgrity:ENABle?
Example	STAT:QUES:INT:ENAB 8 Measurement Uncalibrated Summary will be reported to the Integrity Summary of the Status Questionable register.
Preset	32767
SCPI Status Bits/OPC Dependencies	Sequential command
Min	0
Max	32767
Instrument S/W Revision	Prior to A.02.00

Questionable Integrity Event Query

This query returns the decimal value of the sum of the bits in the Questionable Integrity Event register.

NOTE The register requires that the associated PTR or NTR filters be set before a condition register bit can set a bit in the event register. The data in this register is latched until it is queried. Once queried, the register is cleared.

Mode	All
Remote Command	:STATus:QUESTionable:INTEgrity[:EVENT]?
Example	STAT:QUES:INT?
Preset	0
SCPI Status Bits/OPC Dependencies	Sequential command
Instrument S/W Revision	Prior to A.02.00

Questionable Integrity Negative Transition

This command determines which bits in the Questionable Integrity Condition register will set the corresponding bit in the Questionable Integrity Event register when the condition register bit has a negative transition (1 to 0)

The variable <integer> is the sum of the decimal values of the bits that you want to enable.

Mode	All
Remote Command	:STATus:QUESTionable:INTEgrity:NTRansition <integer> :STATus:QUESTionable:INTEgrity:NTRansition?
Example	STAT:QUES:INT:NTR 8 Measurement 'regained calibration' Summary will be reported to the Integrity Summary of the Status Questionable register.
Preset	0
SCPI Status Bits/OPC Dependencies	Sequential command
Min	0
Max	32767
Instrument S/W Revision	Prior to A.02.00

Questionable Integrity Positive Transition

This command determines which bits in the Questionable Integrity Condition register will set the corresponding bit in the Questionable Integrity Event register when the condition register bit has a positive transition (0 to 1). The variable <integer> is the sum of the decimal values of the bits that you want to enable.

Mode	All
Remote Command	:STATus:QUESTionable:INTEgrity:PTRansition <integer> :STATus:QUESTionable:INTEgrity:PTRansition?
Example	STAT:QUES:INT:PTR 8 Measurement 'became uncalibrated' Summary will be reported to the Integrity Summary of the Status Questionable register.
Preset	32767
SCPI Status Bits/OPC Dependencies	Sequential command
Min	0
Max	32767
Instrument S/W Revision	Prior to A.02.00

Questionable Integrity Signal Register

Questionable Integrity Signal Condition

This query returns the decimal value of the sum of the bits in the Questionable Integrity Signal Condition register.

NOTE The data in this register is continuously updated and reflects the current conditions.

Mode	All
Remote Command	:STATus:QUESTionable:INTEgrity:SIGNal:CONDition?
Example	STAT:QUES:INT:SIGN:COND?
Preset	0
SCPI Status Bits/OPC Dependencies	Sequential command
Instrument S/W Revision	Prior to A.02.00

Questionable Integrity Signal Enable

This command determines which bits in the Questionable Integrity Signal Condition Register will set bits in the Questionable Integrity Signal Event register, which also sets the Integrity Summary bit (bit 9) in the Questionable Register. The variable <integer> is the sum of the decimal values of the bits you want to enable.

Mode	All
Remote Command	:STATus:QUESTionable:INTEgrity:SIGNal:ENABle <integer> :STATus:QUESTionable:INTEgrity:SIGNal:ENABle?
Example	STAT:QUES:INT:SIGN:ENAB 4 Burst Not Found will be reported to the Integrity Summary of the Status Questionable register.
Preset	32767
SCPI Status Bits/OPC Dependencies	Sequential command
Min	0
Max	32767
Instrument S/W Revision	Prior to A.02.00

Questionable Integrity Signal Event Query

This query returns the decimal value of the sum of the bits in the Questionable Integrity Signal Event register.

NOTE The register requires that the associated PTR or NTR filters be set before a condition register bit can set a bit in the event register. The data in this register is latched until it is queried. Once queried, the register is cleared.

Mode	All
Remote Command	:STATus:QUESTionable:INTEgrity:SIGNal[:EVENT]?
Example	STAT:QUES:INT:SIGN?
Preset	0
SCPI Status Bits/OPC Dependencies	Sequential command
Instrument S/W Revision	Prior to A.02.00

Questionable Integrity Signal Negative Transition

This command determines which bits in the Questionable Integrity Signal Condition register will set the corresponding bit in the Questionable Integrity Signal Event register when the condition register bit has a negative transition (1 to 0). The variable <integer> is the sum of the decimal values of the bits that you want to enable.

Mode	All
Remote Command	:STATus:QUESTionable:INTEgrity:SIGNal:NTRansition <integer> :STATus:QUESTionable:INTEgrity:SIGNal:NTRansition?
Example	STAT:QUES:INT:SIGN:NTR 4 Burst found will be reported to the Integrity Summary of the Status Questionable register.
Preset	0
SCPI Status Bits/OPC Dependencies	Sequential command
Min	0
Max	32767
Instrument S/W Revision	Prior to A.02.00

Questionable Integrity Signal Positive Transition

This command determines which bits in the Questionable Integrity Signal Condition register will set the corresponding bit in the Questionable Integrity Signal Event register when the condition register bit has a positive transition (0 to 1). The variable <integer> is the sum of the decimal values of the bits that you want to enable.

Mode	All
Remote Command	:STATus:QUESTionable:INTEgrity:SIGNal:PTRansition <integer> :STATus:QUESTionable:INTEgrity:SIGNal:PTRansition?
Example	STAT:QUES:INT:SIGN:PTR 4 Burst not found will be reported to the Integrity Summary of the Status Questionable register.
Preset	32767
SCPI Status Bits/OPC Dependencies	Sequential command
Min	0
Max	32767
Instrument S/W Revision	Prior to A.02.00

Questionable Integrity Uncalibrated Register

Questionable Integrity Uncalibrated Condition

This query returns the decimal value of the sum of the bits in the Questionable Integrity Uncalibrated Condition register.

NOTE The data in this register is continuously updated and reflects the current conditions.

Mode	All
Remote Command	:STATus:QUESTionable:INTEgrity:UNCalibrated:CONDition?
Example	STAT:QUES:INT:UNC:COND?
Preset	0
SCPI Status Bits/OPC Dependencies	Sequential command
Instrument S/W Revision	Prior to A.02.00

Questionable Integrity Uncalibrated Enable

This command determines which bits in the Questionable Integrity Uncalibrated Condition Register will set bits in the Questionable Integrity Uncalibrated Event register, which also sets the Data Uncalibrated Summary bit (bit 3) in the Questionable Integrity Register. The variable <integer> is the sum of the decimal values of the bits you want to enable.

Mode	All
Remote Command	:STATus:QUESTionable:INTEgrity:UNCalibrated:ENABle :STATus:QUESTionable:INTEgrity:UNCalibrated:ENABle?
Example	STAT:QUES:INT:UNC:ENAB 1 Oversweep (Meas Uncal) will be reported to the Integrity Summary of the Status Questionable register.
Preset	32767
SCPI Status Bits/OPC Dependencies	Sequential command
Min	0
Max	32767
Instrument S/W Revision	Prior to A.02.00

Questionable Integrity Uncalibrated Event Query

This query returns the decimal value of the sum of the bits in the Questionable Integrity Uncalibrated Event register.

NOTE The register requires that the associated PTR or NTR filters be set before a condition register bit can set a bit in the event register. The data in this register is latched until it is queried. Once queried, the register is cleared.

Mode	All
Remote Command	:STATus:QUESTionable:INTEgrity:UNCalibrated[:EVENT]?
Example	STAT:QUES:INT:UNC?
Preset	0
SCPI Status Bits/OPC Dependencies	Sequential command
Instrument S/W Revision	Prior to A.02.00

Questionable Integrity Uncalibrated Negative Transition

This command determines which bits in the Questionable Integrity Uncalibrated Condition register will set the corresponding bit in the Questionable Integrity Uncalibrated Event register when the condition register bit has a negative transition (1 to 0). The variable <integer> is the sum of the decimal values of the bits that you want to enable.

Mode	All
Remote Command	:STATus:QUESTionable:INTEgrity:UNCalibrated:NTRansition <integer> :STATus:QUESTionable:INTEgrity:UNCalibrated:NTRansition ?
Example	STAT:QUES:INT:UNC:NTR 1 Oversweep cleared will be reported to the Integrity Summary of the Status Questionable register.
Preset	0
SCPI Status Bits/OPC Dependencies	Sequential command
Min	0
Max	32767
Instrument S/W Revision	Prior to A.02.00

Questionable Integrity Uncalibrated Positive Transition

This command determines which bits in the Questionable Integrity Uncalibrated Condition register will set the corresponding bit in the Questionable Integrity Uncalibrated Event register when the condition register bit has a positive transition (0 to 1). The variable <integer> is the sum of the decimal values of the bits that you want to enable.

Mode	All
Remote Command	:STATus:QUESTionable:INTEgrity:UNCalibrated:PTRansition <integer> :STATus:QUESTionable:INTEgrity:UNCalibrated:PTRansition ?
Example	STAT:QUES:INT:UNC:PTR 1 Oversweep (Meas Uncal) occurred will be reported to the Integrity Summary of the Status Questionable register.
Preset	32767
SCPI Status Bits/OPC Dependencies	Sequential command
Min	0
Max	32767
Instrument S/W Revision	Prior to A.02.00

Questionable Power Register

Questionable Power Condition

This query returns the decimal value of the sum of the bits in the Questionable Power Condition register.

NOTE The data in this register is continuously updated and reflects the current conditions.

Mode	All
Remote Command	:STATus:QUESTionable:POWer:CONDition?
Example	STAT:QUES:POW:COND?
Preset	0
SCPI Status Bits/OPC Dependencies	Sequential command
Instrument S/W Revision	Prior to A.02.00

Questionable Power Enable

This command determines which bits in the Questionable Power Condition Register will set bits in the Questionable Power Event register, which also sets the Power Summary bit (bit 3) in the Questionable Register. The variable <integer> is the sum of the decimal values of the bits you want to enable.

Mode	All
Remote Command	:STATus:QUESTionable:POWer:ENABle <integer> :STATus:QUESTionable:POWer:ENABle?
Example	STAT:QUES:POW:ENAB 32 50 MHz Input Pwr too High for Cal will be reported to the Power Summary of the Status Questionable register.
Preset	32767
SCPI Status Bits/OPC Dependencies	Sequential command
Min	0
Max	32767
Instrument S/W Revision	Prior to A.02.00

Questionable Power Event Query

This query returns the decimal value of the sum of the bits in the Questionable Power Event register.

NOTE The register requires that the associated PTR or NTR filters be set before a condition register bit can set a bit in the event register. The data in this register is latched until it is queried. Once queried, the register is cleared.

Mode	All
Remote Command	:STATus:QUESTionable:POWer[:EVENT]?
Example	STAT:QUES:POW?
Preset	0
SCPI Status Bits/OPC Dependencies	Sequential command
Instrument S/W Revision	Prior to A.02.00

Questionable Power Negative Transition

This command determines which bits in the Questionable Power Condition register will set the corresponding bit in the Questionable Power Event register when the condition register bit has a negative transition (1 to 0). The variable <integer> is the sum of the decimal values of the bits that you want to enable.

Mode	All
Remote Command	:STATus:QUESTionable:POWer:NTRansition <integer> :STATus:QUESTionable:POWer:NTRansition?
Example	STAT:QUES:POW:NTR 32 50 MHz Input Power became OK for Cal will be reported to the Power Summary of the Status Questionable register.
Preset	0
SCPI Status Bits/OPC Dependencies	Sequential command
Min	0
Max	32767
Instrument S/W Revision	Prior to A.02.00

Questionable Power Positive Transition

This command determines which bits in the Questionable Power Condition register will set the corresponding bit in the Questionable Power Event register when the condition register bit has a positive transition (0 to 1). The variable <integer> is the sum of the decimal values of the bits that you want to enable.

Mode	All
Remote Command	:STATus:QUESTionable:POWer:PTRansition <integer> :STATus:QUESTionable:POWer:PTRansition?>
Example	STAT:QUES:POW:PTR 32 50 MHz Input Power became too high for Cal will be reported to the Power Summary of the Status Questionable register.
Preset	32767
SCPI Status Bits/OPC Dependencies	Sequential command
Min	0
Max	32767
Instrument S/W Revision	Prior to A.02.00

Questionable Temperature Register

Questionable Temperature Condition

This query returns the decimal value of the sum of the bits in the Questionable Temperature Condition register.

NOTE The data in this register is continuously updated and reflects the current conditions.

Mode	All
Remote Command	:STATus:QUESTionable:TEMPerature:CONDition?
Example	STAT:QUES:TEMP:COND?
Preset	0
SCPI Status Bits/OPC Dependencies	Sequential command
Instrument S/W Revision	Prior to A.02.00

Questionable Temperature Enable

This command determines which bits in the Questionable Temperature Condition Register will set bits in the Questionable Temperature Event register, which also sets the Temperature Summary bit (bit 4) in the Questionable Register. The variable <integer> is the sum of the decimal values of the bits you want to enable.

Mode	All
Remote Command	:STATus:QUESTionable:TEMPerature:ENABle <integer> :STATus:QUESTionable:TEMPerature:ENABle?
Example	STAT:QUES:TEMP:ENAB 1 Reference Oscillator Oven Cold will be reported to the Temperature Summary of the Status Questionable register.
Preset	32767
SCPI Status Bits/OPC Dependencies	Sequential command
Min	0
Max	32767
Instrument S/W Revision	Prior to A.02.00

Questionable Temperature Event Query

This query returns the decimal value of the sum of the bits in the Questionable Temperature Event register.

NOTE The register requires that the associated PTR or NTR filters be set before a condition register bit can set a bit in the event register. The data in this register is latched until it is queried. Once queried, the register is cleared

Mode	All
Remote Command	:STATus:QUESTionable:TEMPerature[:EVENT]?
Example	STAT:QUES:TEMP?
Preset	0
SCPI Status Bits/OPC Dependencies	Sequential command
Instrument S/W Revision	Prior to A.02.00

Questionable Temperature Negative Transition

This command determines which bits in the Questionable Temperature Condition register will set the corresponding bit in the Questionable Temperature Event register when the condition register bit has a negative transition (1 to 0). The variable <integer> is the sum of the decimal values of the bits that you want to enable.

Mode	All
Remote Command	:STATus:QUESTionable:TEMPerature:NTRansition <integer> :STATus:QUESTionable:TEMPerature:NTRansition?
Example	STAT:QUES:TEMP:NTR 1 Reference Oscillator Oven not cold will be reported to the Temperature Summary of the Status Questionable register.
Preset	0
SCPI Status Bits/OPC Dependencies	Sequential command
Min	0
Max	32767
Instrument S/W Revision	Prior to A.02.00

Questionable Temperature Positive Transition

This command determines which bits in the Questionable Temperature Condition register will set the corresponding bit in the Questionable Temperature Event register when the condition register bit has a positive transition (0 to 1). The variable <integer> is the sum of the decimal values of the bits that you want to enable.

Mode	All
Remote Command	:STATus:QUESTionable:TEMPerature:PTRansition <integer> :STATus:QUESTionable:TEMPerature:PTRansition?
Example	STAT:QUES:TEMP:PTR 1 Reference Oscillator Oven became cold will be reported to the Temperature Summary of the Status Questionable register.
Preset	32767
SCPI Status Bits/OPC Dependencies	Sequential command
Min	0
Max	32767
Instrument S/W Revision	Prior to A.02.00

IEEE Common GPIB Commands

Numeric values for bit patterns can be entered using decimal or hexi-decimal representations. (i.e. 0 to 32767 is equivalent to #H0 to #H7FFF).

Calibration Query

*CAL? Performs a full alignment and returns a number indicating the success of the alignment. A zero is returned if the alignment is successful. A one is returned if any part of the alignment fails. The equivalent SCPI command is CALibrate[:ALL]?

Clear Status

Clears the status byte register. It does this by emptying the error queue and clearing all bits in all of the event registers. The status byte register summarizes the states of the other registers. It is also responsible for generating service requests.

Key Path	No equivalent key. Related key System, Show Errors, Clear Error Queue
Remote Command	*CLS
Example	*CLS Clears the error queue and the Status Byte Register.
Remote Command Notes	For related commands, see the SYSTem:ERRor[:NEXT]? command. See also the STATus:PRESet command and all commands in the STATus subsystem.
SCPI Status Bits/OPC Dependencies	Resets all bits in all event registers to 0, which resets all the status byte register bits to 0 also.
Instrument S/W Revision	Prior to A.02.00

Standard Event Status Enable

Selects the desired bits from the standard event status enable register. This register monitors I/O errors and synchronization conditions such as operation complete, request control, query error, device dependent error, status execution error, command error, and power on. The selected bits are OR'd to become a summary bit (bit 5) in the byte register which can be queried.

The query returns the state of the standard event status enable register.

Key Path	No equivalent key. Related key System, Show Errors, Clear Error Queue
Remote Command	*ESE <integer> *ESE?
Example	*ESE 36 Enables the Standard Event Status Register to monitor query and command errors (bits 2 and 5). *ESE? Returns a 36 indicating that the query and command status bits are enabled.

Programming the Analyzer

IEEE Common GPIB Commands

Remote Command Notes	For related commands, see the <i>STATus</i> subsystem and <i>SYSTem:ERRor[:NEXT]?</i> commands.
Preset	255
SCPI Status Bits/OPC Dependencies	Event Enable Register of the Standard Event Status Register.
State Saved	Not saved in state.
Min	0
Max	255
Instrument S/W Revision	Prior to A.02.00

Standard Event Status Register Query

Queries and clears the standard event status event register. (This is a destructive read.) The value returned is a hexadecimal number that reflects the current state (0/1) of all the bits in the register.

Remote Command:	*ESR?
Example:	*ESR? Returns a 1 if there is either a query or command error, otherwise it returns a zero.
Remote Command Notes:	For related commands, see the <i>STATus</i> subsystem commands.
Preset:	0
SCPI Status Bits/OPC Dependencies:	Standard Event Status Register (bits 0 – 7).
Min:	0
Max:	255
Instrument S/W Revision:	Prior to A.02.00

Identification Query

Returns a string of instrument identification information. The string will contain the model number, serial number, and firmware revision.

The response is organized into four fields separated by commas. The field definitions are as follows:

- Manufacturer
- Model
- Serial number
- Firmware version

Key Path **No equivalent key. See related key *System, Show System*.**

Remote Command	*IDN?
Example	*IDN? Returns instrument identification information, such as: Agilent Technologies,N9020A,US01020004,A.01.02
Instrument S/W Revision	Prior to A.02.00

Operation Complete

The *OPC command sets bit 0 in the standard event status register (SER) to “1” when pending operations have finished, that is when all overlapped commands are complete. It does not hold off subsequent operations. You can determine when the overlapped commands have completed either by polling the OPC bit in SER, or by setting up the status system such that a service request (SRQ) is asserted when the OPC bit is set.

The *OPC? query returns a “1” after all the current overlapped commands are complete. So it holds off subsequent commands until the "1" is returned, then the program continues. This query can be used to synchronize events of other instruments on the external bus.

Remote Command:	*OPC *OPC?
Example:	INIT:CONT 0 Selects single sweeping. INIT:IMM Initiates a sweep. *OPC? Holds off any further commands until the sweep is complete.
SCPI Status Bits/OPC Dependencies:	Not global to all remote ports or front panel. *OPC only considers operation that was initiated on the same port as the *OPC command was issued from. *OPC is an overlapped command, but *OPC? is sequential.
Instrument S/W Revision:	Prior to A.02.00

Query Instrument Options

Returns a string of all the installed instrument options. It is a comma separated list with quotes, such as: “503,P03,PFR”.

To be IEEE compliant, this command should return an arbitrary ascii variable that would not begin and end with quotes. But the quotes are needed to be backward compatible with previous Spectrum Analyzer products and software. So, the actual implementation will use arbitrary ascii. But quotes will be sent as the first and last ascii characters that are sent with the comma-separated option list.

Remote Command:	*OPT?
Instrument S/W Revision:	Prior to A.02.00

Recall Instrument State

This command recalls the instrument state from the specified instrument memory register.

- If the state being loaded has a newer firmware revision than the revision of the instrument, no state is recalled and an error is reported.
- If the state being loaded has an equal firmware revision than the revision of the instrument, the state will be loaded.
- If the state being loaded has an older firmware revision than the revision of the instrument, the instrument will only load the parts of the state that apply to the older revision.

Remote Command:	*RCL <register #>
Example:	*RCL 7 Recalls the instrument state that is currently stored in register 7.
Restriction and Notes:	Registers 0 through 6 are accessible from the front panel in menu keys for Recall Registers.
SCPI Status Bits/OPC Dependencies:	The command is sequential.
Min:	0
Max:	127
Instrument S/W Revision:	Prior to A.02.00

Save Instrument State

This command saves the current instrument state and mode to the specified instrument memory register.

Remote Command:	*SAV <register #>
Example:	*SAV 9 Saves the instrument state in register 9.
Restriction and Notes:	Registers 0 through 6 are accessible from the front panel in menu keys for Save Registers.
SCPI Status Bits/OPC Dependencies:	The command is sequential.
Min:	0
Max:	127
Instrument S/W Revision:	Prior to A.02.00

Service Request Enable

This command enables the desired bits of the service request enable register.

The query returns the value of the register, indicating which bits are currently enabled.

Remote Command:	*SRE <integer> *SRE?
Example:	*SRE 22 Enables bits 1, 2, and 4 in the service request enable register.
Remote Command Notes:	For related commands, see the STATus subsystem and SYSTem:ERRor[:NEXT]? commands.
Preset:	0
SCPI Status Bits/OPC Dependencies:	Service Request Enable Register (all bits, 0 – 7).
Min:	0
Max:	255
Instrument S/W Revision:	Prior to A.02.00

Status Byte Query

Returns the value of the status byte register without erasing its contents.

Remote Command:	*STB?
Example:	*STB? Returns a decimal value for the bits in the status byte register. For example, if a 16 is returned, it indicates that bit 5 is set and one of the conditions monitored in the standard event status register is set.
Remote Command Notes:	See related command *CLS.
SCPI Status Bits/OPC Dependencies:	Status Byte Register (all bits, 0 – 7).
Instrument S/W Revision:	Prior to A.02.00

Trigger

This command triggers the instrument. Use the `:TRIGger[:SEQuence]:SOURce` command to select the trigger source.

Key Path	No equivalent key. See related keys Single and Restart.
Remote Command	*TRG
Example	*TRG Triggers the instrument to take a sweep or start a measurement, depending on the current instrument settings.
Remote Command Notes	See related command <code>:INITiate:IMMediate</code> .
Instrument S/W Revision	Prior to A.02.00

Self Test Query

This query performs the internal self-test routines and returns a number indicating the success of the testing. A zero is returned if the test is successful, 1 if it fails.

Remote Command:	*TST?
Example:	*TST? Runs the self-test routines and returns 0=passed, 1=some part failed.
Instrument S/W Revision:	Prior to A.02.00

Wait-to-Continue

This command causes the instrument to wait until all overlapped commands are completed before executing any additional commands. There is no query form for the command.

Remote Command:	*WAI
Example:	INIT:CONT OFF; INIT;*WAI Sets the instrument to single sweep. Starts a sweep and waits for its completion.
SCPI Status Bits/OPC Dependencies:	Not global to all remote ports or front panel. *OPC only considers operation that was initiated on the same port as the *OPC command was issued from.
Instrument S/W Revision:	Prior to A.02.00

File

Opens a menu of keys which access various standard and custom Windows dialogs. Pressing any other front-panel key exits any of these dialogs.

Instrument S/W Revision Prior to A.02.00

File Explorer

Opens the standard Windows File Explorer. Pressing any front-panel key closes the Explorer application. File Explorer opens up in My Documents.

Instrument S/W Revision Prior to A.02.00

Page Setup

Refer to your Microsoft Windows Operating System manual.

Instrument S/W Revision Prior to A.02.00

Print Theme – Remote Command

The graphical user interface contains a selection for choosing the Theme to use when printing. An equivalent remote command is provided. Refer to the View/Display section for more detail on Themes.

Mode	All
Remote Command	:SYSTem:PRINT:THEME TDCoLor TDMonochrome FCoLoR FMONochrome :SYSTem:PRINT:THEME?
Example	:SYST:PRIN:THEM FCOL
Preset	FCOL; not part of Preset, but is reset by Restore Misc Defaults or Restore System Defaults All and survives subsequent running of the modes
State Saved	No
Instrument S/W Revision	Prior to A.02.00

Print

Refer to your Microsoft Windows Operating System manual.

Exit

This key, when pressed, will exit the Instrument Application. A dialog box will be used to confirm that you intended to exit the application:

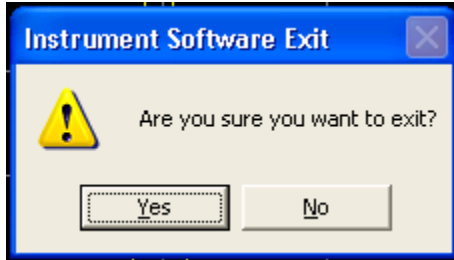

Key Path	File, Exit
Mode	All
Remote Command Notes	The Instrument Application will be closed. No further SCPI commands can be sent after this command. Use with caution!
Instrument S/W Revision	Prior to A.02.00

Preset

Mode Preset

The Mode preset is the most common way to get the active mode back to a known state. It will keep you in the currently active mode and reset the mode settings to their mode preset state. It will never cause a mode switch. It does a partial preset. It does not affect any mode persistent settings or any system settings.

The **Mode Preset** does the following for the currently active mode:

- Aborts the currently running measurement.
- Brings up the default menu for the mode, with no active function.
- Sets Measurement settings to their preset values for the active mode only.
- Activates the default measurement.
- Brings up the default menu for the mode.
- Clears the input and output buffers.
- Sets Status Byte to 0.

Key Path	Front-panel key
Remote Command	:SYSTem:PRESet
Example	:SYST:PRES
Remote Command Notes	*RST is preferred over :SYST:PRES for remote operation. *RST does a Mode Preset as done by the :SYST:PRES command and it sets the measurement mode to Single measurement rather than Continuous for optimal remote control throughput.
Restriction and Notes	Clears all pending OPC bits. The Status Byte is set to 0.
Dependencies/Couplings	A Mode Preset will cause the currently running measurement to be aborted and cause the default measurement to be active. Mode Preset gets the mode to a consistent state with all of the default couplings set.
Instrument S/W Revision	Prior to A.02.00

How-To Preset

The table below shows all possible presets, their corresponding SCPI commands and front panel access (Key Path). Instrument settings depend on the current measurement context. Some settings are local to the current measurement, some are global (common) across all the measurement in the current mode, and some are global to all the available modes. In a similar way, restoring the settings to their preset state can be done within the different contexts.

The Auto Couple front-panel key is a Meas local key. It sets all Auto/Man parameter couplings in the measurement to Auto. Any Auto/Man selection that is local to the other measurements in the mode will not be affected by Auto Couple.

The Meas Preset key is a Meas local key. Meas Preset resets all the variables local to the current measurement except the persistent ones.

The Mode Preset (front-panel key on front panel) resets all the current mode's Meas local and Meas global variables except the persistent ones.

The Restore Mode Defaults key resets ALL the Mode variables (and all the Meas global and Meas local variables), including the persistent ones.

Type Of Preset	SCPI Command	Front Panel Access
Auto Couple	:COUPle ALL	Auto Couple front-panel key
Meas Preset	:CONFigure:<Measurement>	Meas Setup Menu
Mode Preset	:SYSTem:PRESet	Mode Preset (green key)
Restore Mode Defaults	:INSTrument:DEFault	Mode Setup Menu
Restore All Mode Defaults	:SYSTem:DEFault MODEs	System Menu; Restore System Default Menu
*RST	*RST	not possible (Mode Preset with Single)
Restore Input/Output Defaults	:SYSTem:DEFault INPut	System Menu; Restore System Default Menu
Restore Power On Defaults	:SYSTem:DEFault PON	System Menu; Restore System Default Menu
Restore Alignment Defaults	:SYSTem:DEFault ALIGN	System Menu; Restore System Default Menu
Restore Miscellaneous Defaults	:SYSTem:DEFault MISC	System Menu; Restore System Default Menu
Restore All System Defaults	:SYSTem:DEFault [ALL] :SYSTem:PRESet:PERSistent	System Menu; Restore System Default Menu
User Preset	:SYSTem:PRESet:USER	User Preset Menu
User Preset All Modes	:SYSTem:PRESet:USER:ALL	User Preset Menu
Power On Mode Preset	:SYSTem:PON:TYPE MODE	System Menu
Power On User Preset	:SYSTem:PON:TYPE USER	System Menu
Power On Last State	:SYSTem:PON:TYPE LAST	System Menu

Restore Mode Defaults

Restore Mode Defaults resets the state for the currently active mode by resetting the mode persistent settings to their factory default values, clearing mode data and by performing a Mode Preset. This function will never cause a mode switch. This function performs a full preset for the currently active mode; whereas, Mode Preset performs a partial preset. Restore Mode Defaults does not affect any system settings. System settings are reset by Restore System Defaults. This function does reset mode data; as well as settings.

Key Path	Mode Setup
Remote Command	:INSTRument:DEFault
Example	:INST:DEF
Remote Command Notes	Clears all pending OPC bits. The Status Byte is set to 0.
Restriction and Notes	A pop-up message comes up saying: "If you are sure, press key again".
Dependencies/Couplings	A Restore Mode Defaults will cause the currently running measurement to be aborted and causes the default measurement to be active. It gets the mode to a consistent state with all of the default couplings set.
Instrument S/W Revision	Prior to A.02.00

***RST (Remote Command Only)**

*RST is equivalent to :SYST:PRES:INIT:CONT OFF which is a Mode Preset in Single measurement state. This remote command is preferred over Mode Preset remote command - :SYST:PRES, as optimal remote programming occurs with the instrument in single measurement state.

Remote Command:	*RST
Example:	*RST
Remote Command Notes:	Sequential
Restriction and Notes:	Clears all pending OPC bits and the Status Byte is set to 0.
Dependencies/Couplings:	A *RST will cause the currently running measurement to be aborted and cause the default measurement to be active. *RST gets the mode to a consistent state with all of the default couplings set.
Instrument S/W Revision:	Prior to A.02.00

Print

The Print front-panel key is equivalent to performing a File, Print, OK. It immediately performs the currently configured Print to the current printer.

Key Path	Front-panel key
Instrument S/W Revision	Prior to A.02.00

Quick Save

The Quick Save front-panel key repeats the most recent save which was performed from the Save menu, with some qualification:

Quick Save pays no attention to register saves. Register saves are not remembered as Saves for the purpose of Quick Save

If the current measurement does not support the last non-register save that was performed, an informational message is generated, “File type not supported for this measurement”

Quick Save repeats the last type of qualified save (that is, a save qualified by the above criteria) in the last save directory by creating a unique filename using the Auto File Naming algorithm described below.

If Quick Save is pressed after startup and before any qualified Save has been performed, the Quick Save performs a Screen Image save using the current settings for Screen Image saves (current theme, current directory), which then becomes the “last save” for the purpose of subsequent Quick Saves.

The Auto File Naming feature automatically generates a file name for use when saving a file. The filename consists of a prefix and suffix separated by a dot, as is standard for the Windows® file system. For details on the suffix for each file type, see the documentation for the Save front-panel key. A default prefix exists for each of the available file types:

Type	Default Prefix	Menu
State	State_	(Save/Recall)
Trace + State	State_	(Save/Recall)
Screen	Screen_	(Save/Recall)
Amplitude Corrections	Ampcor_	(Import/Export)
Traces	Trace_	(Import/Export)
Limit Lines	LLine_	(Import/Export)
Measurement Result	MeasR_	(Import/Export)
Capture Buffer	CapBuf_	(Import/Export)

A four digit number is appended to the prefix to create a unique file name. The numbering sequence starts at 0000 within each Mode for each file type and works its way up to 9999, then wraps to 0000 again. It remembers where it was through a Mode Preset and when leaving and returning to the Mode. It is reset by Restore Misc Defaults and Restore System Defaults and subsequent running of the instrument application. So, for example, the first auto file name generated for State files is State_0000.state. The next is State_0001, and so forth.

One of the key features of Auto File Name is that we guarantee that the Auto File Name will never conflict with an existing file. This is because the whole point of Auto File Name is to relieve you from having to pick a file name. The algorithm looks for the next available number. If it gets to 9999, then it looks for holes. If it find no holes; i.e. no more numbers are available, it gives an error.

For example, if when we get to State_0010.state there is already a State_0010.state file in the current directory, we advance the counter to State_0011.state to ensure that no conflict will exist (and then we verify that State_0011.state also doesn't exist in the current directory and advance again if it does, et cetera).

If you enter a file name for a given file type, then the prefix becomes the filename you entered instead of the default prefix, followed by an underscore. The last four letters (the suffix) are the 4-digit number.

For example, if you save a Meas Results file as "fred.csv", then the next auto file name chosen for a Meas Results save will be fred_0000.csv.

NOTE Although 0000 is used in the example above, the number that is used is actually the current number in the Meas Results sequence, that is, the number that would have been used if you had not entered their own file name.

NOTE If the filename you entered ends with _dddd, where d=any number, making it look just like an auto file name, then the next auto file name picks up where you left off with the suffix being dddd + 1.

Key Path	Quick Save
Remote Command Notes	No remote command for this key specifically.
Instrument S/W Revision	Prior to A.02.00

Recall

Operation of this key is identical across several measurements. For details about this key, see [“Recall” on page 569](#).

Save

Operation of this key is identical across several measurements. For details about this key, see [“Save” on page 593](#).

System

Opens a menu of keys that access various configuration menus and dialogs.

Key Path	Front-panel key
Remote Command Notes	No remote command for this key specifically.
Instrument S/W Revision	Prior to A.02.00

Show

Opens a menu of choices that enable you to select the information window you want to view.

Key Path	System
Mode	All
Remote Command	:SYSTem:SHOW OFF ERRor SYSTem HARDware LXI HWSTatistics ALIGNment SOFTware :SYSTem:SHOW?
Example	:SYST:SHOW SYST
Remote Command Notes	This command displays (or exits) the various System information screens.
Preset	OFF
State Saved	No
Range	OFF ERRor SYSTem HARDware LXI HWSTatistics ALIGNment SOFTware
Instrument S/W Revision	Prior to A.02.00

Errors

There are two modes for the Errors selection, History and Status.

The list of errors displayed in the Errors screen does not automatically refresh; you must press the Refresh button or leave the screen and return to it to refresh it.

History brings up a screen displaying the event log in chronological order, with the newest event at the top. The history queue can hold up to 100 messages (if a message has a repeat count greater than 1 it only counts once against this number of 100). Note that this count bears no relation to the size of the SCPI queue. If the queue extends onto a second page, a scroll bar appears to allow scrolling with a mouse. Time is displayed to the second.

Status brings up a screen summarizing the status conditions currently in effect. Note that the time is displayed to the second.

The fields on the Errors display are:

Type (unlabeled) - Displays the icon identifying the event or condition as an error or warning.

ID - Displays the error number.

Message - Displays the message text.

Repeat (RPT) - This field shows the number of consecutive instances of the event, uninterrupted by other events. In other words, if an event occurs 5 times with no other intervening event, the value of repeat will be 5.

If the value of Repeat is 1 the field does not display. If the value of Repeat is >1, the time and date shown are those of the most recent occurrence. If the value of repeat reaches 999,999 it stops there.

Time - Shows the most recent time (including the date) at which the event occurred.

Key Path	System, Show
Mode	All
Remote Command	:SYSTem:ERRor [:NEXT] ?
Example	:SYST:ERR?
Restriction and Notes	The return string has the format: “<Error Number>,<Error>” Where <Error Number> and <Error> are defined in the Master Error Messages document.
State Saved	No
Instrument S/W Revision	Prior to A.02.00

Next Page

Next Page and Previous Page menu keys move you between pages of the log, if it fills more than one page. These keys are grayed out in some cases:

If on the last page of the log, the Next Page key is grayed out

If on the first page of the log, the Previous Page key is grayed out.

If there is only one page, both keys are grayed out.

Key Path	System, Show, Errors
Instrument S/W Revision	Prior to A.02.00

Previous Page

See “[Next Page](#)” on page 159.

Key Path	System, Show, Errors
Instrument S/W Revision	Prior to A.02.00

History

The History and Status keys select the Errors view. The Status key has a second line which shows a number in [square brackets]. This is the number of currently open status items.

Key Path	System, Show, Errors
Instrument S/W Revision	Prior to A.02.00

Status

See “[History](#)” on page 160.

Verbose SCPI On/Off

This is a capability that will allow the SCPI data stream to be displayed when a SCPI error is detected, showing the characters which stimulated the error and several of the characters preceding the error.

Key Path	System, Show, Errors
Mode	All
Remote Command	:SYSTem:ERRor:VERBoSe OFF ON 0 1 :SYSTem:ERRor:VERBoSe?
Example	:SYST:ERR:VERB ON
Preset	This is unaffected by Preset but is set to OFF on a “Restore System Defaults->Misc”
State Saved	No
Range	On Off
Instrument S/W Revision	Prior to A.02.00

Refresh

When pressed, refreshes the Show Errors display.

Key Path	System, Show, Errors
Instrument S/W Revision	Prior to A.02.00

Clear Error Queue

This clears all errors in all error queues.

Clear Error Queue does not affect the current status conditions.

Mode Preset does not clear the error queue.

Restore System Defaults will clear all error queues.

*CLS only clears the queue if it is sent remotely and *RST does not affect any error queue.

Switching modes does not affect any error queues.

Key Path	System, Show, Errors
Instrument S/W Revision	Prior to A.02.00

System

The System screen is formatted into three groupings: product descriptive information, options tied to the hardware, and software products:

```

<Product Name> <Product Description>
Product Number: N9020A
Serial Number: US46220924
Firmware Revision: A.01.01
Computer Name: <hostname>
Host ID: N9020A,US44220924

N9020A-503      Frequency Range to 3.6 GHz
N9020A-PFR     Precision Frequency Reference
N9020A-P03     Preamp 3.6 GHz

N9060A-2FP     Spectrum Analysis Measurement Suite  1.0.0.0
N9073A-1FP     WCDMA                               1.0.0.0
N9073A-2FP     WCDMA with HSDPA                     1.0.0.0
  
```

The Previous Page is unavailable if the first page of information is presently displayed. The Next Page menu key is unavailable if the last page is information is presently displayed.

Key Path	System, Show
Mode	All
Example	SYST:SHOW SYST
Instrument S/W Revision	Prior to A.02.00

LXI

This key shows you the product number, serial number, firmware revision, computer name, IP address, Host ID, LXI Class, LXI Version, MAC Address, and the Auto-MDIX Capability.

Tip: For information about setting up measurements using LXI, refer to the "Programmer's Guide" located in your analyzer at: C:/Program Files/Agilent/Signal Analysis/Help/Bookfiles/x_series_prog.pdf. It is also available by selecting the "Additional Documentation" page of the Help.

Key Path	System, Show
Instrument S/W Revision	Prior to A.02.00

LXI Event Log

The event log records all of the LXI LAN event activity. As LXI LAN events are sent or received, the activity is noted in the Event Log with an IEEE 1588 timestamp. When the event log is selected, the current contents of the event log are displayed in the system information screen.

The fields recorded in the Event Log are:

- The date the event occurred (GMT)
- The time the event occurred (GMT)
- The type of event: LAN Input, LAN Output, Status, Alarm, Trigger Alarm, Trigger LAN
- The name of the event
- The edge associated with the event
- The event's identifier: This is the string that appears on the LAN.
- The source event: This is only valid for LAN Output, Trigger LAN, and Trigger Alarm event types.
- The source address: This is only valid for LAN Input event types. It is the address from which the message originated.
- The destination address: This is only valid for LAN Output event types. It is the address (or addresses) that the message will be sent to. For UDP messages, this field reads "ALL."

Key Path	System, Show, LXI
Instrument S/W Revision	Prior to A.02.00

Next Page

See ["Next Page" on page 159](#)

Key Path	System, Show, Errors
Instrument S/W Revision	Prior to A.02.00

Previous Page

See “Next Page” on page 159.

Key Path	System, Show, Errors
Instrument S/W Revision	Prior to A.02.00

Circular

Sets the behavior for entries that occur while the LXI Event Log is full.

- If Circular is set to 1, incoming events overwrite the oldest events in the log.
- If Circular is set to 0, incoming events are discarded.

Key Path	System, Show, LXI, LXI Event Log
Remote Command	:LXI:EVENT:LOG:CIRCular[:ENABLE] ON OFF 1 0 :LXI:EVENT:LOG:CIRCular[:ENABLE]?
Example	:LXI:EVEN:LOG:CIRC 1
Preset	Not affected by a Preset. The default value of "ON" can be restored by pressing System, Restore Defaults, Misc.
State Saved	Saved in instrument state.
Range	OFF ON 0 1
Instrument S/W Revision	Prior to A.02.00

Clear

Clears the event log of all entries.

Key Path	System, Show, LXI, LXI Event Log
Remote Command	:LXI:EVENT:LOG:CLEAR
Example	:LXI:EVEN:LOG:CLEAR
Instrument S/W Revision	Prior to A.02.00

Size

Sets the maximum number of entries the LXI Event Log can hold.

Key Path	System, Show, LXI, LXI Event Log
Remote Command	:LXI:EVENT:LOG:SIZE <size> :LXI:EVENT:LOG:SIZE?
Example	:LXI:EVEN:LOG:SIZE 256

Preset	Not affected by a Preset. The default value of "64" can be restored by pressing System, Restore Defaults, Misc.
State Saved	Saved in instrument state.
Range	>= 0
Instrument S/W Revision	Prior to A.02.00

Enabled

Enables and disables the logging of LXI Events.

Key Path	System, Show, LXI, LXI Event Log
Remote Command	:LXI:EVENT:LOG:ENABle ON OFF 1 0 :LXI:EVENT:LOG:ENABle?
Example	:LXI:EVENT:LOG:ENAB ON
Preset	Not affected by a Preset. The default value of "ON" can be restored by pressing System, Restore Defaults, Misc.
State Saved	Saved in instrument state.
Range	ON OFF 0 1
Instrument S/W Revision	Prior to A.02.00

Count (Remote Command Only)

Returns the number of entries currently in the LXI Event Log.

Remote Command:	:LXI:EVENT:LOG:COUNT?
Example:	:LXI:EVENT:LOG:COUN?
Range:	0 – Size
Instrument S/W Revision:	Prior to A.02.00

Next Entry (Remote Command Only)

Returns the oldest entry from the LXI Event Log and removes it from the log. If the log is empty, an empty string is returned.

Remote Command:	:LXI:EVENT:LOG[:NEXT]?
Example:	:LXI:EVENT:LOG?
Instrument S/W Revision:	Prior to A.02.00

System Functions System

All (Remote Command Only)

Non-destructively retrieves the entire contents of the event log. Entries are returned as separate strings, surrounded by double quote marks, and separated by a comma. Fields within each entry are also comma delimited.

Remote Command: : LXI : EVEnt : LOG : ALL?

Example: : LXI:EVEN:LOG:ALL? Returns the entire event log contents.

An example may look like the following:

```
"11/12/2007,18:14:10.770385,Error,LogOverwrite,Rise,,,", "11/12/2007,18:14:10.592105,Status,Measuring,Rise,,,", "11/12/2007,18:14:10.597758,Status,Measuring,Fall,,,", "11/12/2007,18:14:10.597786,Status,Sweeping,Fall,,,", "11/12/2007,18:14:10.599030,Status,WaitingForTrigger,Rise,,,"
```

The contents of the Event Log vary, based on the operation of the instrument.

Instrument S/W Revision: Prior to A.02.00

Specific Entry (Remote Command Only)

Non-destructively retrieves a specifically indexed entry from the event log. Fields within an entry are comma delimited.

Remote Command: : LXI : EVEnt : LOG : ENTRy? <intIndex>

Example: : LXI:EVEN:LOG:ENTR? 0 Returns the first entry in the event log.

An example may look like the following:

```
"11/12/2007,18:14:10.770385,Error,LogOverwrite,Rise,,,"
```

The contents of the Event Log vary, based on the operation of the instrument.

Instrument S/W Revision: Prior to A.02.00

Beginning Entry (Remote Command Only)

Sets or freezes the beginning entry of the log when in circular mode to the most recently added entry at the time of the command. This is so that the :LXI:EVEnt:LOG:ENTry? command has a reference entry for indexing individual entries in the log.

Remote Command: : LXI : EVEnt : LOG : CIRCular : FBENry

Example: : LXI:EVEN:LOG:CIRC:FBEN

Instrument S/W Revision: Prior to A.02.00

Power On

The Power On menu key enables you to select how the instrument should power on. The options are: Mode and Input/Output Defaults, User Preset and Last State.

Key Path	System
Mode	All

Remote Command	:SYSTem: PON: TYPE MODE USER LAST PRESet :SYSTem: PON: TYPE?
Example	:SYST: PON: TYPE MODE
Preset	This is unaffected by Preset but is set to Mode on a “Restore System Defaults->All”
State Saved	No
Instrument S/W Revision	Prior to A.02.00

Mode and Input/Output Defaults

When the analyzer is powered on in Mode and Input/Output Defaults, it will perform a Restore Mode Defaults to all modes in the instrument and a Restore Input/Output Defaults as well.

Key Path	System, Power On
Mode	All
Example	SYST:PON:TYPE MODE
Instrument S/W Revision	Prior to A.02.00

User Preset

Sets **Power On** to **User Preset**. When the analyzer is powered on in User Preset, it will User Preset each mode and switch to the power-on mode. Power On User Preset will not affect any settings beyond what a normal User Preset affects.

NOTE An instrument could never power up for the first time in User Preset.

Key Path	System, Power On
Mode	All
Example	SYST:PON:TYPE USER
Instrument S/W Revision	Prior to A.02.00

Last State

Sets **Power On to Last**. When the analyzer is powered on, it will put all modes in the last state they were in prior to when the analyzer was put into Power Standby and it will wake up in the mode it was last in prior to powering off the instrument. The saving of the active mode prior to shutdown happens behind the scenes when a controlled shutdown is requested by using the front panel power **Standby** key or by using the remote command `SYSTem:PDOWn`. The non-active modes are saved as they are deactivated and recalled by Power On Last State.

NOTE

An instrument could never power up for the first time in Last.

If line power to the analyzer is interrupted, for example by pulling the line cord plug or by switching off power to a test rack, Power On Last State will not work properly.

Key Path	System, Power On
Mode	All
Example	SYST:PON:TYPE LAST
Restriction and Notes	Power on Last State only works if you have done a controlled shutdown prior to powering on in Last. If a controlled shutdown is not done when in Power On Last State, the instrument will power up in the last active mode, but it may not power up in the active mode's last state. If an invalid mode state is detected, a Mode Preset will occur. To control the shutdown under remote control use the <code>:SYSTem:PDOWn</code> command.
Instrument S/W Revision	Prior to A.02.00

Power On Application

This menu key brings up a Mode Menu that lists the available modes and lets you select which Mode is to be the power-on mode.

This application is used for Power On Type "Mode and Input/Output Defaults" and Restore System Defaults All.

Key Path	System, Power On
Mode	All
Remote Command	:SYSTem: PON:MODE SA BASIC ADEMOD NFIGURE PNOISE CDMA2K TDSCDMA VSA VSA89 601 WCDMA WIMAXOFDMA :SYSTem: PON:MODE?
Example	SYST:PON:MODE SA
Restriction and Notes	The list of possible modes (and remote parameters) to choose from is dependent on which modes are installed in the instrument.

Preset	This is unaffected by Preset but is set on a “Restore System Defaults->All” to SA unless Spectrum Analysis mode is not installed in the instrument in which case the factory will load the default power-on mode.
State Saved	No
Instrument S/W Revision	Prior to A.02.00

Configure Applications

The Configure Application utility allows you configure the bootup for fastest first mode switch time or faster boot time. In addition, there are more applications available for the X-Series than can fit into Windows® Virtual Memory. The Configure Application utility allows you to choose which licensed applications to load in-memory. There will be multiple opportunities for you to perform the configuration.

The Configure Applications utility will provide a graphical representation of the amount of Virtual Memory consumed. The indicator will be green when <90% of the memory limit is consumed, yellow for memory consumption is 90% to 100%, and red when consumption is >100% of the limit.

Key Path	System, Power On
Instrument S/W Revision	A.02.00

Configure Applications - Next application startup

Select All

Select All marks all applications in the selection list. This allows you to enable all applications licensed on the instrument for pre-loading, or is a convenience for selecting all applications in one operation and then letting you deselect individual applications.

Key Path	System, Power On, Configure Applications
Instrument S/W Revision	A.02.00

Deselect All

Deselect All removes marks from all applications in the selection list, with the exception of the Power On application (the Power On application cannot be eliminated from the pre-load list). This allows you to disable all applications licensed on the instrument for pre-loading (with the exception of the Power On application), or is a convenience for deselecting all applications in one operation and then select individual applications.

Key Path	System, Power On, Configure Applications
Instrument S/W Revision	A.02.00

Move Up

The application list is the order in which applications appear in the Mode Menu. Move Up shifts the selected application up in the list, thus moving the selected application earlier in the Mode Menu.

Key Path	System, Power On, Configure Applications
Instrument S/W Revision	A.02.00

Move Down

The application list is the order in which applications appear in the Mode Menu. Move Down shifts the selected application down in the list, thus moving the selected application later in the Mode Menu.

Key Path	System, Power On, Configure Applications
Instrument S/W Revision	A.02.00

Select/Deselect

Toggles the currently highlighted application in the list.

Key Path	System, Power On, Configure Applications
Instrument S/W Revision	A.02.00

Save Changes

Applies the configuration of applications list: marked application will be pre-loaded in memory the next time the instrument application is started, and the order of applications in the list will be the order of applications in the Mode Menu.

Key Path	System, Power On, Configure Applications
Notes	The menu key will be unavailable when the virtual memory of the selected applications exceeds 100% of the limit.
Instrument S/W Revision	A.02.00

System Restart

System Restart provides a means to restart the instrument application. Upon restart the applications in the pre-load list will be loaded in memory.

Key Path	System, Power On, Configure Applications
Remote Command	:SYSTem:PUP:PROcess
Example	:SYST:PUP:PROC Must Wait after this command for the instrument application to restart

Notes You cannot use *WAI or *OPC? to synchronize operation; this command stops and restarts the instrument application, thus the SCPI operation is terminated and restarted. A remote program must use fixed wait time to resume sending commands to the instrument. The wait time will be dependent upon which applications are pre-loaded.

Instrument S/W Revision A.02.00

Configure Applications - Remote commands

Configuration list (Remote Command Only)

This remote command is used to set or query the list of applications to be loaded in-memory.

Remote Command: :SYSTem:PON:APPLication:LLIST <string of INSTRument:SElect names>
:SYSTem:PON:APPLication:LLIST?

Example: :SYST:PON:APPL:LLIS "SA,BASIC,WCDMA"

Notes: <string of INSTRument:SElect names> are from the enums of the :INSTRument:SElect command in Meas Common section 13.3
The order of the <INSTRument:SElect names> is the order in which the applications are loaded into memory, and the order in which they appear in the Mode Menu.
Error -225 "Out of Memory" is reported when more applications are listed than can reside in Virtual Memory. In such circumstance the existing applications load list is unchanged.

Preset: Not affected by Preset

State Saved: Not saved in state

Instrument S/W Revision: A.02.00

Configuration Memory Available (Remote Command Only)

This remote command is used to query the amount of Virtual Memory remaining.

Remote Command: :SYSTem:PON:APPLication:VMEMory[:AVAIlable]?

Example: :SYST:PON:APPL:VMEM?

Preset: Not affected by Preset

Instrument S/W Revision: A.02.00

Configuration Memory Total (Remote Command Only)

This remote command is used to query the limit of Virtual Memory allowed for applications.

Remote Command: :SYSTem:PON:APPLication:VMEMory:TOTal?
Example: :SYST:PON:APPL:VMEM:TOT?
Preset: Not affected by Preset
Instrument S/W Revision: A.02.00

Configuration Memory Used (Remote Command Only)

This remote command is a query of the amount of Virtual Memory used by all measurement applications.

Remote Command: :SYSTem:PON:APPLication:VMEMory:USED?
Example: :SYST:PON:APPL:VMEM:USED?
Preset: Not affected by Preset
Instrument S/W Revision: A.02.00

Configuration Application Memory (Remote Command Only)

This remote command is used to query the amount of Virtual Memory a particular application consumes.

Remote Command: :SYSTem:PON:APPLication:VMEMory:USED:NAME?
 <INSTRument:SELEct name>
Example: :SYST:PON:APPL:VMEM:USED:NAME? CDMA2K
Notes: <INSTRument:SELEct name> is from the enums of the :INSTRument:SELEct
 command in Meas Common section 13.3
 Value returned will be 0 (zero) if the name provided is invalid.
Preset: Not affected by Preset
Instrument S/W Revision: A.01.70 or later

Restore Power On Defaults

This selection causes the Power On Type and Power On Application settings to be a reset to their default value. This level of Restore System Defaults does not affect any other system settings, mode settings and does not cause a mode switch. The Power On menu key under the Restore System Defaults menu causes the same action.

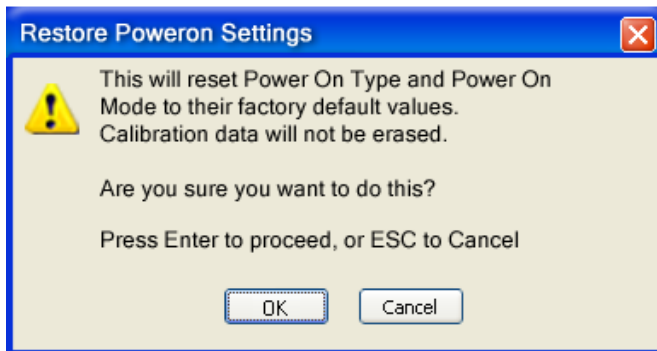

If you press any key other than OK or Enter, it is construed as a Cancel, because the only path that will actually cause the reset to be executed is through OK or Enter.

Key Path	System, Power On
Example	:SYST:DEF PON
Instrument S/W Revision	Prior to A.02.00

Alignments

The Alignments Menu controls and displays the automatic alignment of the instrument, and provides the ability to restore the default alignment values.

The current setting of the alignment system is displayed in the system Settings Panel along the top of the display, including a warning icon for conditions that may cause specs to be impacted, for example:



Key Path	System
Instrument S/W Revision	Prior to A.02.00

Auto Align

Configures the method for which the automatic background alignment is run.

Automatic background alignments are run periodically between measurement acquisitions. The instrument's software determines when alignments are to be performed to maintain warranted operation. The recommended setting for **Auto Align** is **Normal**.

An Auto Align execution cannot be aborted with the Cancel (ESC) key. To interrupt an Auto Align execution, select **Auto Align Off**.

Key Path	System, Alignments
Mode	All
Remote Command	:CALibration:AUTO ON PARTial OFF ALERT :CALibration:AUTO?

System Functions System

Example	:CAL:AUTO ON
Restriction and Notes	While Auto Align is executing, bit 0 of Status Operation register is set.
Preset	This is unaffected by Preset but is set to ON upon a “Restore System Defaults->Align”.
SCPI Status Bits/OPC Dependencies	When Auto Align is executing, bit 0 in the Status Operational register is set.
Dependencies/Couplings	Auto Align is set to Off if Restore Align Data is invoked.
State Saved	No
Instrument S/W Revision	Prior to A.02.00

Normal

Auto Align, Normal turns on the automatic alignment of all measurement systems. **Auto Align, Normal** maintains the instrument in warranted operation across varying temperature and over time.

If the condition “Align Now, All required” is set, transition to **Auto Align, Normal** will perform the required alignments and clear the “Align Now, All required” condition and then continue with further alignments as required to maintain the instrument adequately aligned for warranted operation.

When **Auto Align, Normal** is selected the Auto Align Off time is set to zero.

When **Auto Align, Normal** is selected the Settings Panel indicates ALIGN AUTO.

Key Path	System, Alignments, Auto Align
Mode	All
Example	:CAL:AUTO ON
Restriction and Notes	<p>Alignment processing as a result of the transition to Normal will be executed sequentially. Thus, *OPC? or *WAI following CAL:AUTO ON will return when the alignment processing is complete.</p> <p>The presence of an external signal may interfere with the RF portion of the alignment. If so, the Error Condition “Align skipped: 50 MHz interference” or “Align skipped: 4.8 GHz interference” is reported, and bit 11 is set in the Status Questionable Calibration register. After the interfering signal is removed, subsequent alignment of the RF will clear the condition, and clear bit 11 in the Status Questionable Calibration register.</p>
SCPI Status Bits/OPC Dependencies	<p>An interfering user signal may prevent automatic alignment of the RF subsystem. If this occurs, the Error Condition “Align skipped: 50 MHz interference” or “Align skipped: 4.8 GHz interference” is reported, the Status Questionable Calibration bit 11 is set, and the alignment proceeds. When a subsequent alignment of the RF subsystem succeeds, either by the next cycle of automatic alignment or from an Align Now, RF, the Error Condition and Status Questionable Calibration bit 11 are cleared.</p>
Instrument S/W Revision	Prior to A.02.00

Partial

Auto Align, Partial disables the full automatic alignment and the maintenance of warranted operation for the benefit of improved measurement throughput. Accuracy is retained for the Resolution Bandwidth filters and the IF Passband which is critical to FFT accuracy, demodulation, and many measurement applications. With Auto Align set to **Partial**, you are now responsible for maintaining warranted operation by updating the alignments when they expire. The **Auto Align, Alert** mechanism will notify you when alignments have expired. One solution to expired alignments is to perform the **Align All, Now** operation. Another is to return the **Auto Align** selection to **Normal**.

Auto Align, Partial is recommended for measurements where the throughput is so important that a few percent of improvement is more valued than an increase in the accuracy errors of a few tenths of a decibel. One good application of **Auto Align, Partial** would be an automated environment where the alignments can be called during overhead time when the device-under-test is exchanged.

When **Auto Align, Partial** is selected the elapsed time counter begins for Auto Align Off time.

When **Auto Align, Partial** is selected the Settings Panel indicates ALIGN PARTIAL with a warning icon. The warning icon is to inform the operator that they are responsible for maintaining the warranted operation of the instrument

Key Path	System, Alignments, Auto Align
Mode	All
Example	:CAL:AUTO PART
Restriction and Notes	Auto Align Partial begins the elapsed time counter for Auto Align Off time.
Instrument S/W Revision	Prior to A.02.00

Off

Auto Align, Off disables automatic alignment and the maintenance of warranted operation, for the benefit of maximum measurement throughput. With Auto Align set to **Off**, you are now responsible for maintaining warranted operation by updating the alignments when they expire. The **Auto Align, Alert** mechanism will notify you when alignments have expired. One solution to expired alignments is to perform the **Align All, Now** operation. Another is to return the **Auto Align** selection to **Normal**.

The **Auto Align, Off** setting is rarely the best choice, because **Partial** gives almost the same improvement in throughput while maintaining the warranted performance for a much longer time. The **Off** choice is intended for unusual circumstances such as the measurement of radar pulses where you might like the revisit time to be as consistent as possible.

When **Auto Align, Off** is selected the Auto Align Off time is initialized and the elapsed time counter begins.

When **Auto Align, Off** is selected the Settings Panel indicates ALIGN OFF with a warning icon. The warning icon is to inform the operator that they are responsible for maintaining the warranted operation of the instrument:

Key Path	System, Alignments, Auto Align
Mode	All

System Functions System

Example	:CAL:AUTO OFF
Restriction and Notes	Auto Align Off begins the elapsed time counter for Auto Align Off time.
Dependencies/Couplings	Auto Align is set to Off if Restore Align Data is invoked.
Instrument S/W Revision	Prior to A.02.00

All but RF

Auto Align, All but RF, configures automatic alignment to include or exclude the RF subsystem. (Eliminating the automatic alignment of the RF subsystem prevents the input impedance from changing. The normal input impedance of 50 ohms can change to an open circuit when alignments are being used. Some devices under test do not behave acceptably under such circumstances, for example by showing instability.) When **Auto Align, All but RF ON** is selected, the operator is responsible for performing an **Align Now, RF** when RF-related alignments expire. The **Auto Align, Alert** mechanism will notify the operator to perform an **Align Now, All** when the combination of time and temperature variation is exceeded.

When **Auto Align, All but RF ON** is selected the Settings Panel indicates ALIGN AUTO/NO RF with a warning icon (warning icon is intended to inform the operator they are responsible for the maintaining the RF alignment of the instrument):

Key Path	System, Alignments, Auto Align
Mode	All
Remote Command	:CALibration:AUTO:MODE ALL NRF :CALibration:AUTO:MODE?
Example	:CAL:AUTO:MODE NRF
Preset	This is unaffected by Preset but is set to ALL on a "Restore System Defaults->Align".
State Saved	No
Instrument S/W Revision	Prior to A.02.00

Alert

The instrument will signal an Alert when conditions exist such that you will need to perform a full alignment (for example, **Align Now, All**). The Alert can be configured in one of four settings; **Time & Temperature, 24 hours, 7 days**, or **None**. A confirmation is required when a selection other than **Time & Temperature** is chosen. This prevents accidental deactivation of alerts.

With **Auto Align** set to **Normal**, the configuration of **Alert** is not relevant because the instrument's software maintains the instrument in warranted operation.

Key Path	System, Alignments, Auto Align
Mode	All

Remote Command	:CALibration:AUTO:ALERT TTEMperature DAY WEEK NONE :CALibration:AUTO:ALERT?
Example	:CAL:AUTO:ALER TTEM
Remote Command Notes	The alert that alignment is needed is the setting of bit 14 in the Status Questionable Calibration register.
Preset	This is unaffected by Preset but is set to TTEMperature on a “Restore System Defaults->Align”.
SCPI Status Bits/OPC Dependencies	The alert is the Error Condition “Align Now, All required” and bit 14 is set in the Status Questionable Calibration register.
State Saved	No
Instrument S/W Revision	Prior to A.02.00

Time & Temperature

With Auto Align Alert set to **Time & Temperature** the instrument will signal an alert when alignments expire due to the combination of the passage of time and changes in temperature. The alert is the Error Condition “Align Now, All required”. If this choice for Alert is selected, the absence of an alert means that the analyzer alignment is sufficiently up-to-date to maintain warranted accuracy.

Key Path	System, Alignments, Auto Align, Alert
Mode	All
Example	:CAL:AUTO:ALER TTEM
SCPI Status Bits/OPC Dependencies	Bit 14 is set in the Status Questionable Calibration register.
Instrument S/W Revision	Prior to A.02.00

24 hours

With Auto Align Alert set to **24 Hours** the instrument will signal an alert after a time span of 24 hours since the last successful full alignment (for example, **Align Now, All** or completion of a full Auto Align). You may choose this selection in an environment where the temperature is stable on a daily basis at a small risk of accuracy errors in excess of the warranted specifications. The alert is the Error Condition “Align Now, All required”.

For front panel operation, confirmation is required to transition into this setting of Alert. The confirmation dialog is:

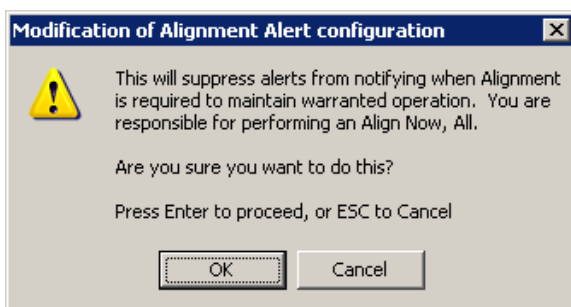

System Functions System

No confirmation is required when Alert is configured through a remote command.

Key Path	System, Alignments, Auto Align, Alert
Mode	All
Example	:CAL:AUTO:ALER DAY
SCPI Status Bits/OPC Dependencies	Bit 14 is set in the Status Questionable Calibration register.
Instrument S/W Revision	Prior to A.02.00

7 days

With Auto Align Alert is set to **7 days** the instrument will signal an alert after a time span of 168 hours since the last successful full alignment (for example, **Align Now, All** or completion of a full Auto Align). You may choose this selection in an environment where the temperature is stable on a weekly basis, at a modest risk of accuracy degradations in excess of warranted performance. The alert is the Error Condition “Align Now, All required”.

For front panel operation, confirmation is required for the customer to transition into this setting of Alert. The confirmation dialog is:

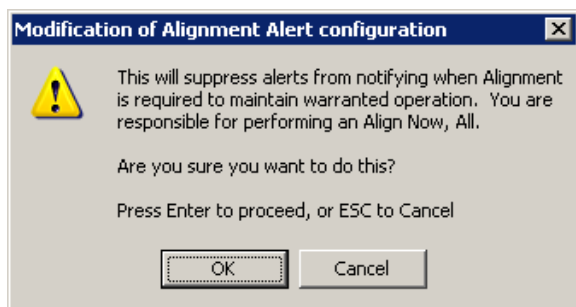

No confirmation is required when Alert is configured through a remote command.

Key Path	System, Alignments, Auto Align, Alert
Mode	All
Example	:CAL:AUTO:ALER WEEK
SCPI Status Bits/OPC Dependencies	Bit 14 is set in the Status Questionable Calibration register.
Instrument S/W Revision	Prior to A.02.00

None

With Auto Align Alert set to **None** the instrument will not signal an alert. This is provided for rare occasions where you are making a long measurement which cannot tolerate Auto Align interruptions, and must have the ability to capture a screen image at the end of the measurement without an alert posted to the display. Agilent does not recommend using this selection in any other circumstances, because of the risk of accuracy performance drifting well beyond expected levels without the operator being informed.

For front panel operation, confirmation is required to transition into this setting of Alert. The confirmation dialog is:

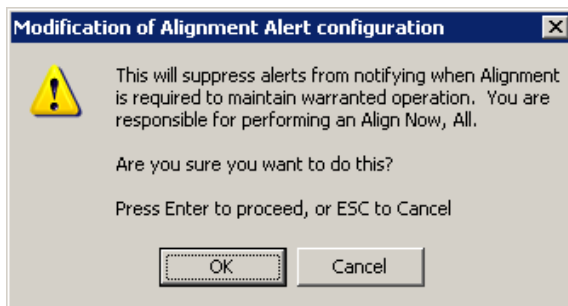

No confirmation is required when Alert is configured through a remote command.

Key Path	System, Alignments, Auto Align, Alert
Mode	All
Example	:CAL:AUTO:ALER NONE
Instrument S/W Revision	Prior to A.02.00

Align Now

Accesses alignment processes that are immediate action operations. They perform complete operations and run until they are complete.

Key Path	System, Alignments
Instrument S/W Revision	Prior to A.02.00

All

Immediately executes an alignment of all subsystems. The instrument stops any measurement currently underway, performs the alignment, then restarts the measurement from the beginning (similar to pressing the **Restart** key).

If an interfering user signal is present at the RF Input, the alignment is performed on all subsystems except the RF. After completion, the Error Condition “Align skipped: 50 MHz interference” or “Align skipped: 4.8 GHz interference” is set. In addition the Error Condition “Align Now, RF required” is set, and bits 11 and 12 are set in the Status Questionable Calibration register.

The query form of the remote commands (:CALibration[:ALL]? or *CAL?) invokes the alignment of all subsystems and returns a success or failure value. An interfering user signal is not grounds for failure; if the alignment was able to succeed on all portions but unable to align the RF because of an interfering signal, the resultant will be the success value.

Successful completion of **Align Now, All** will clear the “Align Now, All required” Error Condition, and clear bit 14 in the Status Questionable Calibration register. It will also begin the elapsed time counter for Last Align Now, All Time, and capture the Last Align Now, All Temperature.

If the Align RF subsystem succeeded in aligning (no interfering signal present), the elapsed time counter

System Functions

System

begins for Last Align Now, RF Time, and the temperature is captured for the Last Align Now, RF Temperature. In addition the Error Conditions “Align skipped: 50 MHz interference” and “Align skipped: 4.8 GHz interference” are cleared, the Error Condition “Align Now, RF required” is cleared, and bits 11 and 12 are cleared in the Status Questionable Calibration register

Align Now, All can be interrupted by pressing the Cancel (ESC) front-panel key or remotely with Device Clear followed by the :ABORt SCPI command. When this occurs the Error Condition “Align Now, All required” is set, and bit 14 is set in the Status Questionable Condition register. This is because new alignment data may be employed for an individual subsystem, but not a cohesive set of data for all subsystems.

In many cases, you might find it more convenient to change alignments to **Normal**, instead of executing **Align Now, All**. When the Auto Align process transitions to **Normal**, the analyzer will immediately start to update only the alignments that have expired, thus efficiently restoring the alignment process.

Key Path	System, Alignments, Align Now
Mode	All
Remote Command	:CALibration[:ALL] :CALibration[:ALL]?
Example	:CAL
Remote Command Notes	:CALibration[:ALL]? returns 0 if successful :CALibration[:ALL]? returns 1 if failed :CALibration[:ALL]? is the same as *CAL? While Align Now, All is performing the alignment, bit 0 in the Status Operation register is set. Completion, or termination, will clear bit 0 in the Status Operation register. This command is sequential; it must complete before further SCPI commands are processed. Interrupting the alignment from remote is accomplished by invoking Device Clear followed by the :ABORt command. Successful completion will clear bit 14 in the Status Questionable Calibration register. An interfering user signal is not grounds for failure of Align Now, All. However, bits 11 and 12 are set in the Status Questionable Calibration register to indicate Align Now, RF is required.
Restriction and Notes	An interfering user supplied signal will result in the instrument requiring an Align Now, RF with the interfering signal removed.
SCPI Status Bits/OPC Dependencies	Bits 11, 12, or 14 may be set in the Status Questionable Calibration register.

Dependencies/Couplings	<p>Initializes the time for the Last Align Now, All Time.</p> <p>Records the temperature for the Last Align Now, All Temperature.</p> <p>If Align RF component succeeded, initializes the time for the Last Align Now, RF Time.</p> <p>If Align RF component succeeded, records the temperature for the Last Align Now, RF Temperature.</p>
Instrument S/W Revision	Prior to A.02.00
Mode	All
Remote Command	*CAL?
Example	*CAL?
Remote Command Notes	<p>*CAL? returns 0 if successful</p> <p>*CAL? returns 1 if failed</p> <p>:CALibration[:ALL]? is the same as *CAL?</p> <p>See additional remarks described with :CALibration[:ALL]?</p>
Restriction and Notes	Everything about :CALibration[:ALL]? is synonymous with *CAL? including all conditions, status register bits, and couplings
Instrument S/W Revision	Prior to A.02.00

All but RF

Immediately executes an alignment of all subsystems except the RF subsystem. The instrument will stop any measurement currently underway, perform the alignment, and then restart the measurement from the beginning (similar to pressing the **Restart** key). This can be used to align portions of the instrument that are not impacted by an interfering user input signal.

This operation might be chosen instead of **All** if you do not want the device under test to experience a large change in input impedance, such as a temporary open circuit at the analyzer input.

The query form of the remote commands (:CALibration:NRF?) will invoke the alignment and return a success or failure value.

Successful completion of **Align Now**, **All but RF** will clear the “Align Now, All required” Error Condition, and clear bit 14 in the Status Questionable Calibration register. If “Align Now, All required” was in effect prior to executing the All but RF, the Error Condition “Align Now, RF required” is asserted and bit 12 in the Status Questionable Calibration register is set. It will also begin the elapsed time counter for Last Align Now, All Time, and capture the Last Align Now, All Temperature.

Align Now, **All but RF** can be interrupted by pressing the Cancel (ESC) front-panel key or remotely with Device Clear followed by the :ABORt SCPI command. When this occurs the Error Condition “Align Now, All required” is set, and bit 14 is set in the Status Questionable Condition register. This is because new alignment data may be used for an individual subsystem, but not a full new set of data for all subsystems.

Key Path	System, Alignments, Align Now
----------	--------------------------------------

System Functions

System

Mode	All
Remote Command	:CALibration:NRF :CALibration:NRF?
Example	:CAL:NRF
Remote Command Notes	:CALibration:NRF? returns 0 if successful :CALibration:NRF? returns 1 if failed While Align Now, All but RF is performing the alignment, bit 0 in the Status Operation register is set. Completion, or termination, will clear bit 0 in the Status Operation register. This command is sequential; it must complete before further SCPI commands are processed. Interrupting the alignment from remote is accomplished by invoking Device Clear followed by the :ABORt command. Successful completion will clear bit 14 in the Status Questionable Calibration register and set bit 12 if invoked with “Align Now, All required”.
SCPI Status Bits/OPC Dependencies	Bits 12 or 14 may be set in the Status Questionable Calibration register.
Dependencies/Couplings	Initializes the time for the Last Align Now, All Time. Records the temperature for the Last Align Now, All Temperature.
Instrument S/W Revision	Prior to A.02.00

RF

Immediately executes an alignment of the RF subsystem. The instrument stops any measurement currently underway, performs the alignment, then restarts the measurement from the beginning (similar to pressing the **Restart** key).

This operation might be desirable if the alignments had been set to not include RF alignments, or if previous RF alignments could not complete because of interference which has since been removed.

If an interfering user signal is present at the RF Input, the alignment will terminate and raise the Error Condition “Align skipped: 50 MHz interference” or “Align skipped: 4.8 GHz interference”, and Error Condition “Align Now, RF required”. In addition, bits 11 and 12 will be set in the Status Questionable Calibration register.

The query form of the remote commands (:CALibration:RF?) will invoke the alignment of the RF subsystem and return a success or failure value. An interfering user signal is grounds for failure.

A failure encountered during alignment will set the Error Condition “Align RF failed” and set bit 3 in the Status Questionable Calibration register.

Successful completion of **Align Now, RF** clears the Error Conditions “Align skipped: 50 MHz interference” and “Align skipped: 4800 MHz interference” and the Error Conditions “Align RF failed” and “Align Now, RF required”, and clears bits 3, 11, and 12 in the Status Questionable Calibration register. It will also begin the elapsed time counter for Last Align Now, RF Time, and capture the Last Align Now, RF Temperature.

Align Now, RF can be interrupted by pressing the Cancel (ESC) front-panel key or remotely with Device Clear followed by the :ABORt SCPI command. When this occurs, the Error Condition “Align Now, RF required” is set, and bit 12 is set in the Status Questionable Condition register. None of the new alignment data is used.

Key Path	System, Alignments, Align Now
Mode	All
Remote Command	:CALibration:RF :CALibration:RF?
Example	:CAL:RF
Remote Command Notes	:CALibration:RF? returns 0 if successful :CALibration:RF? returns 1 if failed (including interfering user signal) While Align Now, RF is performing the alignment, bit 0 in the Status Operation register is set. Completion, or termination, will clear bit 0 in the Status Operation register. This command is sequential; it must complete before further SCPI commands are processed. Interrupting the alignment from remote is accomplished by invoking Device Clear followed by the :ABORt command. Successful completion will clear bits 3, 11, and 12 in the Status Questionable Calibration register. A failure encountered during alignment will set the Error Condition “Align RF failed” and set bit 3 in the Status Questionable Calibration register. An interfering user signal will result in bits 11 and 12 to be set in the Status Questionable Calibration register to indicate Align Now, RF is required.
Restriction and Notes	An interfering user supplied signal will result in the instrument requiring an Align Now, RF with the interfering signal removed.
SCPI Status Bits/OPC Dependencies	Bits 11, 12, or 14 may be set in the Status Questionable Calibration register.
Dependencies/Couplings	Initializes the time for the Last Align Now, RF Time. Records the temperature for the Last Align Now, RF Temperature.
Instrument S/W Revision	Prior to A.02.00

Advanced

Advanced accesses alignment processes that are immediate action operations that perform operations that run until complete. Advanced alignments are performed on an irregular basis, or require additional operator interaction

Key Path	System, Alignments
Instrument S/W Revision	Prior to A.02.00

Characterize Preselector (Only with Option 507, 508, 513, or 526)

The Preselector tuning curve drifts over temperature and time. Recognize that the **Amplitude, Presel Center** function adjusts the preselector for accurate amplitude measurements at an individual frequency. **Characterize Preselector** improves the amplitude accuracy by ensuring the Preselector is approximately centered at all frequencies without the use of the **Amplitude, Presel Center** function. **Characterize Preselector** can be useful in situations where absolute amplitude accuracy is not of utmost importance, and the throughput savings or convenience of not performing a **Presel Center** is desired. **Presel Center** is required prior to any measurement for best (and warranted) amplitude accuracy.

Agilent recommends that the **Characterize Preselector** operation be performed yearly as part of any calibration, but performing this operation every three months can be worthwhile.

Characterize Preselector immediately executes a characterization of the Preselector, which is a YIG-tuned filter (YTF). The instrument stops any measurement currently underway, performs the characterization, then restarts the measurement from the beginning (similar to pressing the **Restart** key).

The query form of the remote commands (:CALibration:YTF?) will invoke the alignment of the YTF subsystem and return a success or failure value.

A failure encountered during alignment will set the Error Condition “Characterize YTF failed” and set bit 9 in the Status Questionable Calibration register.

Successful completion of **Advanced, Characterize Preselector** will clear the Error Condition “Characterize YTF failed”, and clear bit 9 in the Status Questionable Calibration register. It will also begin the elapsed time counter for Last Characterize Preselector Time, and capture the Last Characterize Preselector Temperature.

The last Characterize Preselector Time and Temperature must survive across the power cycle as this operation is performed infrequently.

Advanced, Characterize Preselector can be interrupted by pressing the Cancel (ESC) front-panel key or remotely with Device Clear followed by the :ABORt SCPI command. None of the new characterization data is then used.

Key Path	System, Alignments, Align Now
Mode	All
Remote Command	:CALibration:YTF :CALibration:YTF?
Example	:CAL:YTF

- Remote Command Notes :CALibration:YTF? returns 0 if successful
:CALibration:YTF? returns 1 if failed (including interfering user signal)
- While Advanced, Characterize Preselector is performing the alignment, bit 0 in the Status Operation register is set. Completion, or termination, will clear bit 0 in the Status Operation register.
- This command is sequential; it must complete before further SCPI commands are processed. Interrupting the alignment from remote is accomplished by invoking Device Clear followed by the :ABORT command.
- Successful completion will clear bit 9 in the Status Questionable Calibration register.
- A failure encountered during alignment will set the Error Condition “Characterize Preselector failed” and set bit 9 in the Status Questionable Calibration register.
- For Option 507, 508, 513, and 526 only.
- Dependencies/Couplings Initializes the time for the Last Characterize Preselector Time.
Records the temperature for the Last Characterize Preselector Temperature.
- Instrument S/W Revision Prior to A.02.00

Show Alignment Statistics

Shows alignment information you can use to ensure that the instrument is operating in a specific manner. The Show Alignment Statistics screen is where you can view time and temperature information.

Values which are displayed are only updated when the Show Alignment Statistics screen is invoked, they are not updated while the Show Alignment Statistics screen is being displayed. The remote commands which access this information obtain current values.

An example of the Show Alignment Statistics screen would be similar to:

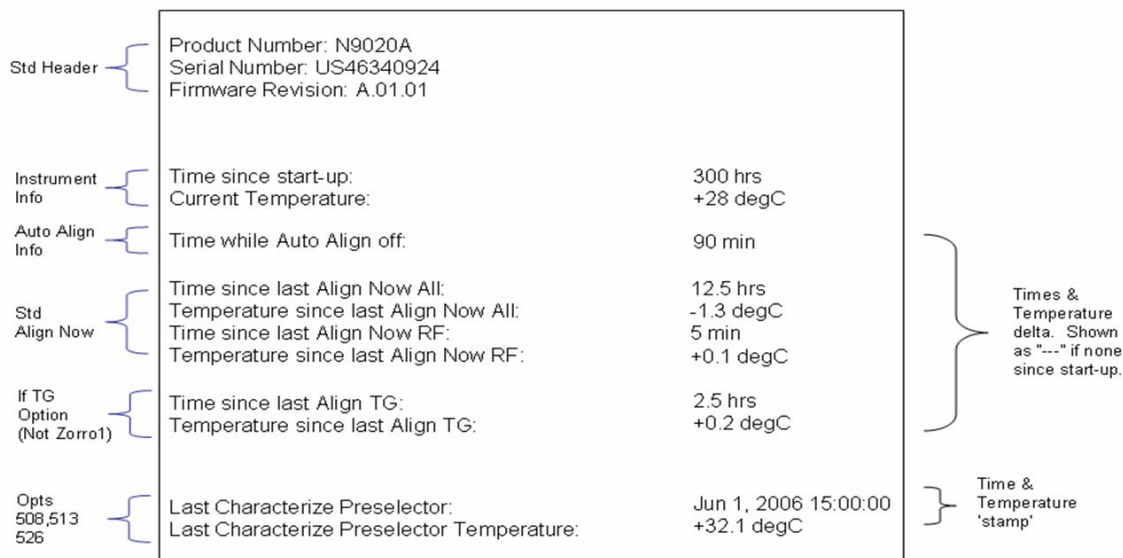

System Functions System

A successful Align Now, RF will set the Last Align RF temperature to the current temperature, and reset the Last Align RF time. A successful Align Now, All or Align Now, All but RF will set the Last Align Now All temperature to the current temperature, and reset the Last Align Now All time. A successful Align Now, All will also reset the Last Align RF items if the RF portion of the Align Now succeeded.

Key Path	System, Alignments
Mode	All
Restriction and Notes	The values displayed on the screen are only updated upon entry to the screen and not updated while the screen is being displayed.
Instrument S/W Revision	Prior to A.02.00
Key Path	Visual annotation in the Show Alignment Statistics screen
Mode	All
Remote Command	:SYSTem: PON: TIME?
Example	:SYST:PON:TIME?
Restriction and Notes	Value is the time since the most recent start-up in seconds.
State Saved	No
Instrument S/W Revision	Prior to A.02.00
Key Path	Visual annotation in the Show Alignment Statistics screen
Mode	All
Remote Command	:CALibration: TEMPerature: CURRent?
Example	:CAL:TEMP:CURR?
Restriction and Notes	Value is in degrees Centigrade. Value is invalid if using default alignment data (Align Now, All required)
State Saved	No
Instrument S/W Revision	Prior to A.02.00
Key Path	Visual annotation in the Show Alignment Statistics screen
Mode	All
Remote Command	:CALibration: TIME: LALL?
Example	:CAL:TIME:LALL?
Restriction and Notes	Value is the elapsed time, in seconds, since the last successful Align Now, All or Align Now, All but RF was executed.
State Saved	No
Instrument S/W Revision	Prior to A.02.00

Key Path	Visual annotation in the Show Alignment Statistics screen
Mode	All
Remote Command	:CALibration:TEMPerature:LALL?
Example	:CAL:TEMP:LALL?
Restriction and Notes	Value is in degrees Centigrade at which the last successful Align Now, All or Align Now, All but RF was executed.
State Saved	No
Instrument S/W Revision	Prior to A.02.00

Key Path	Visual annotation in the Show Alignment Statistics screen
Mode	All
Remote Command	:CALibration:TIME:LRF?
Example	:CAL:TIME:LRF?
Restriction and Notes	Value is the elapsed time, in seconds, since the last successful Align Now, RF was executed, either individually or as a component of Align Now, All.
State Saved	No
Instrument S/W Revision	Prior to A.02.00

Key Path	Visual annotation in the Show Alignment Statistics screen
Mode	All
Remote Command	:CALibration:TEMPerature:LRF?
Example	:CAL:TEMP:LRF?
Restriction and Notes	Value is in degrees Centigrade at which the last successful Align Now, RF was executed, either individually or as a component of Align Now, All.
State Saved	No
Instrument S/W Revision	Prior to A.02.00

Key Path	Visual annotation in the Show Alignment Statistics screen
Mode	All
Remote Command	:CALibration:TIME:LPreselector?
Example	:CAL:TIME:LPR?
Restriction and Notes	Value is date and time the last successful Characterize Preselector was executed. The date is separated from the time by a space character. Returns "" if no Characterize Preselector has ever been performed on the instrument.
State Saved	No

System Functions System

Instrument S/W Revision	Prior to A.02.00
Key Path	Visual annotation in the Show Alignment Statistics screen
Mode	All
Remote Command	:CALibration:TEMPerature:LPreselector?
Example	:CAL:TEMP:LPR?
Restriction and Notes	Value is in degrees Centigrade at which the last successful Characterize Preselector was executed.
State Saved	No
Instrument S/W Revision	Prior to A.02.00

Key Path	Visual annotation in the Show Alignment Statistics screen
Mode	All
Remote Command	:CALibration:AUTO:TIME:OFF?
Example	:CAL:AUTO:TIME:OFF?
Restriction and Notes	Value is the elapsed time, in seconds, since Auto Align has been set to Off or Off with Alert. The value is 0 if Auto Align is ALL or NORF.
State Saved	No
Instrument S/W Revision	Prior to A.02.00

Timebase DAC

Allows control of the internal 10 MHz reference oscillator timebase. This may be used to adjust for minor frequency alignment between the signal and the internal frequency reference. This adjustment has no effect if the instrument is operating with an External Frequency Reference.

If the value of the Timebase DAC changes (by switching to Calibrated from User with User set to a different value, or in User with a new value entered) an alignment may be necessary. The alignment system will take appropriate action; which will either invoke an alignment or cause an Alert.

Key Path	System, Alignments
Mode	All
Remote Command	:CALibration:FREquency:REFerence:MODE CALibrated USER :CALibration:FREquency:REFerence:MODE?
Example	:CAL:FREQ:REF:MODE CAL
Remote Command Notes	If the value of the timebase is changed the alignment system automatically performs an alignment or alerts that an alignment is due.
Restriction and Notes	If the value of the timebase is changed the alignment system automatically performs an alignment or alerts that an alignment is due.

Preset	This is unaffected by Preset but is set to CALibrated on a “Restore System Defaults->Align”.
State Saved	No
Instrument S/W Revision	Prior to A.02.00

Calibrated

Sets the Timebase DAC to the value established during factory or field calibration. The value displayed on the menu key is the calibrated value.

Key Path	System, Alignments, Timebase DAC
Mode	All
Example	:CAL:FREQ:REF:MODE CAL
Instrument S/W Revision	Prior to A.02.00

User

Allows setting the Timebase DAC to a value other than the value established during the factory or field calibration. The value displayed on the menu key is the calibrated value.

Key Path	System, Alignments, Timebase DAC
Mode	All
Example	:CAL:FREQ:REF:MODE USER
Instrument S/W Revision	Prior to A.02.00

Key Path	System, Alignments, Timebase DAC
Mode	All
Remote Command	:CALibration:FREQuency:REFerence:FINE <integer> :CALibration:FREQuency:REFerence:FINE?
Example	:CAL:FREQ:REF:FINE 8191
Restriction and Notes	If the value of the timebase is changed the alignment system automatically performs an alignment or alerts that an alignment is due.
Preset	This is unaffected by Preset but is set to the factory setting on a “Restore System Defaults->Align”.
Dependencies/Couplings	Setting :CAL:FREQ:REF:FINE sets :CAL:FREQ:REF:MODE USER
State Saved	No
Min	0
Max	16383

System Functions System

Instrument S/W Revision	Prior to A.02.00
Remote Command:	:CALibration:FREQuency:REFerence:COARse <integer> :CALibration:FREQuency:REFerence:COARse?
Example:	:CAL:FREQ:REF:COAR 8191
Remote Command Notes:	This is an alias for CAL:FREQ:REF:FINE any change to COARse is reflected in FINE and vice-versa. See CAL:FREQ:REF:FINE for description of functionality.
Dependencies/Couplings:	Setting :CAL:FREQ:REF:COAR sets :CAL:FREQ:REF:MODE USER
Instrument S/W Revision:	Prior to A.02.00

Restore Align Defaults

Initializes the alignment user interface settings, not alignment data, to the factory default values. Align Now, All must be executed if the value of the Timebase DAC results in a change.

For front panel operation, you are prompted to confirm action before setting the alignment parameters to factory defaults:

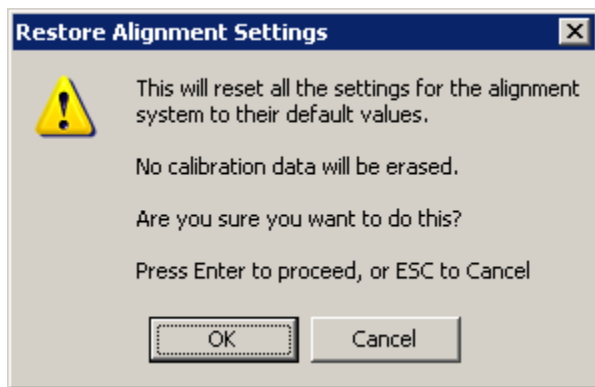

The parameters affected are:

Parameter	Setting
Timebase DAC	Calibrated
Timebase DAC setting	Calibrated value
Auto Align State	Normal (if the instrument is not operating with default alignment data, Off otherwise)
Auto Align All but RF	Off
Auto Align Alert	Time & Temperature
Key Path	System, Alignments
Mode	All

Example	:SYST:DEF ALIG
Restriction and Notes	Alignment processing that results as the transition to Auto Alignment Normal will be executed sequentially; thus *OPC? or *WAI will wait until the alignment processing is complete.
Instrument S/W Revision	Prior to A.02.00

Backup and Restore Alignment Data

Alignment data for the instrument resides on the hard drive in a database. Agilent uses high quality hard drives; however it is highly recommended the alignment data be backed-up to storage outside of the instrument. Additionally, for customers who use multiple CPU Assemblies or multiple disk drives, the alignment that pertains to the instrument must be transferred to the resident hard drive after a CPU or hard drive is replaced. This utility facilitates backing-up and restoring the alignment data.

NOTE	This utility allows the operator to navigate to any location of the Windows file system. It is intended that the operator use an USB memory device or Mapped Network Drive to backup the alignment data to storage outside of the instrument.
-------------	---

Backup or Restore Align Data...

Opens the utility for backing-up or restoring the alignment data.

Key Path	System, Alignments
Instrument S/W Revision	A.02.00
Key Path	System, Alignments
Mode	All
Remote Command	:CALibration:DATA:DEFault
Example	:CAL:DATA:DEF
Dependencies/Couplings	Sets Auto Align to Off. Sets bit 14 in the Status Questionable Calibration register. The Error Condition "Align Now, All required" is set.
Instrument S/W Revision	Prior to A.02.00

Alignment Data Wizard

The Backup or Restore Alignment Data wizard will guide the you through the operation of backing-up or restoring the alignment data.

The following dialogue boxes operate without a mouse or external keyboard when you use the default file names.

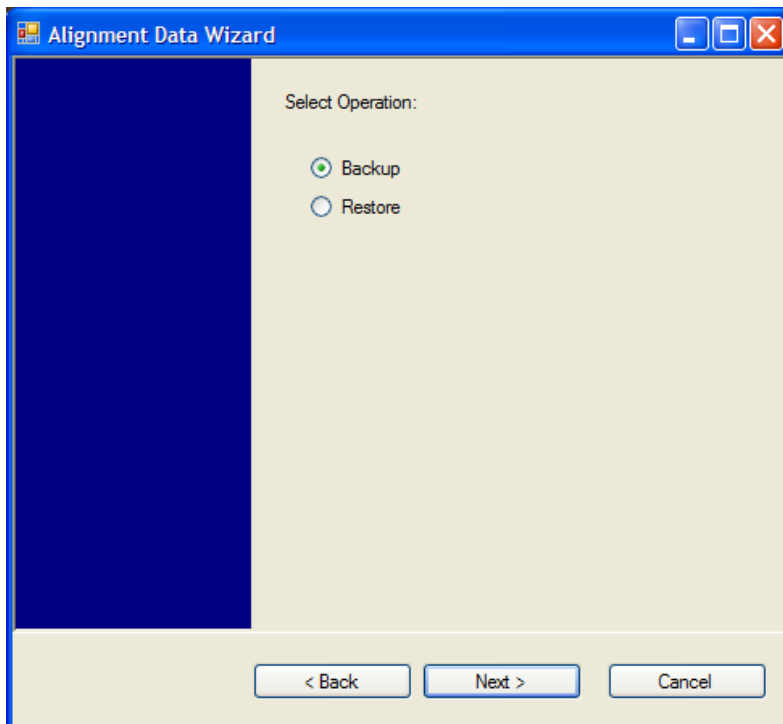
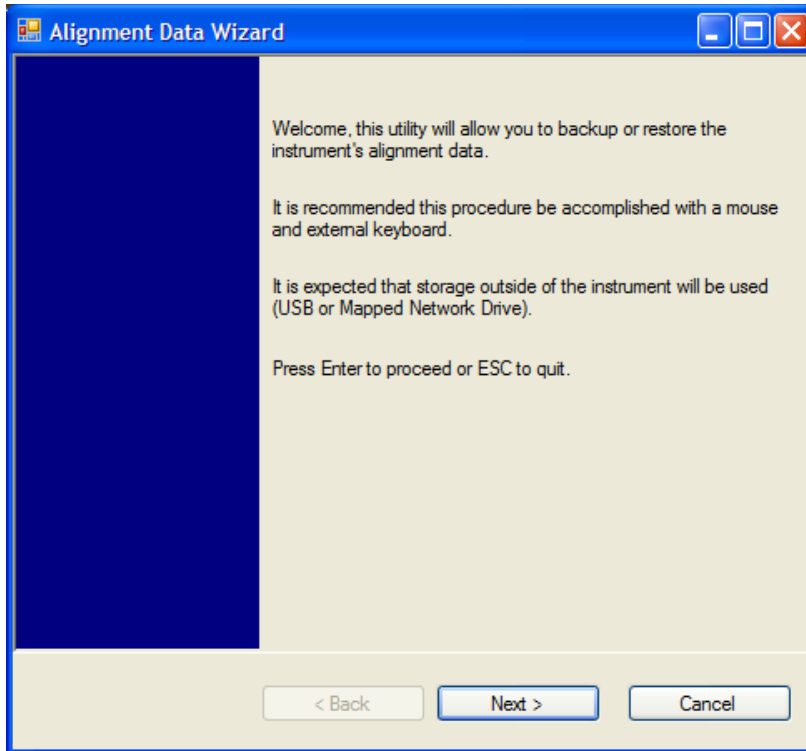

The backup screen will indicate the approximate amount of space required to contain the backup file.

The default file name will be AlignDataBackup_<model number>_<serial number>_<date in YYYYMMDDHHMMSS>.bak.

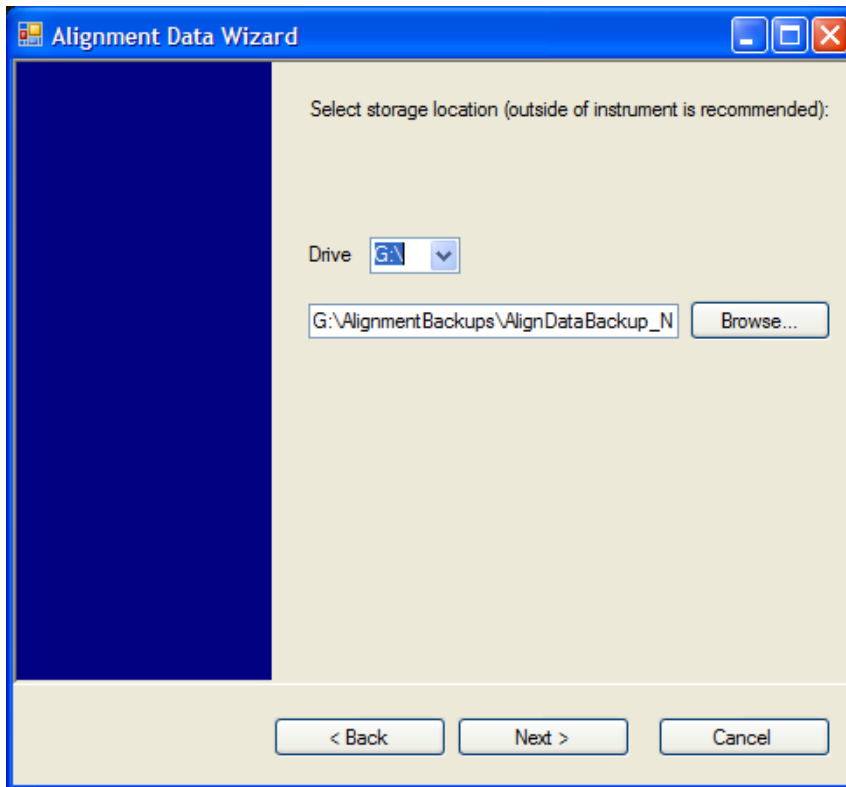

Changing the drive letter will also modify the path displayed in the box below. When this step is first loaded, the drive drop-down is populated with connected drives which provide s you with write access. If there are many unreachable network drives connected to the instrument, this step can take a few seconds. If a USB drive is present, it will be selected by default. The path defaults to the AlignmentBackups folder, and a filename will be automatically created in the form of AlignDataBackup_<model>_<serial number>_<date><time>. When the "Next >" button is pressed, you will be prompted to create a new folder if the chosen path does not yet exist.

System Functions
System

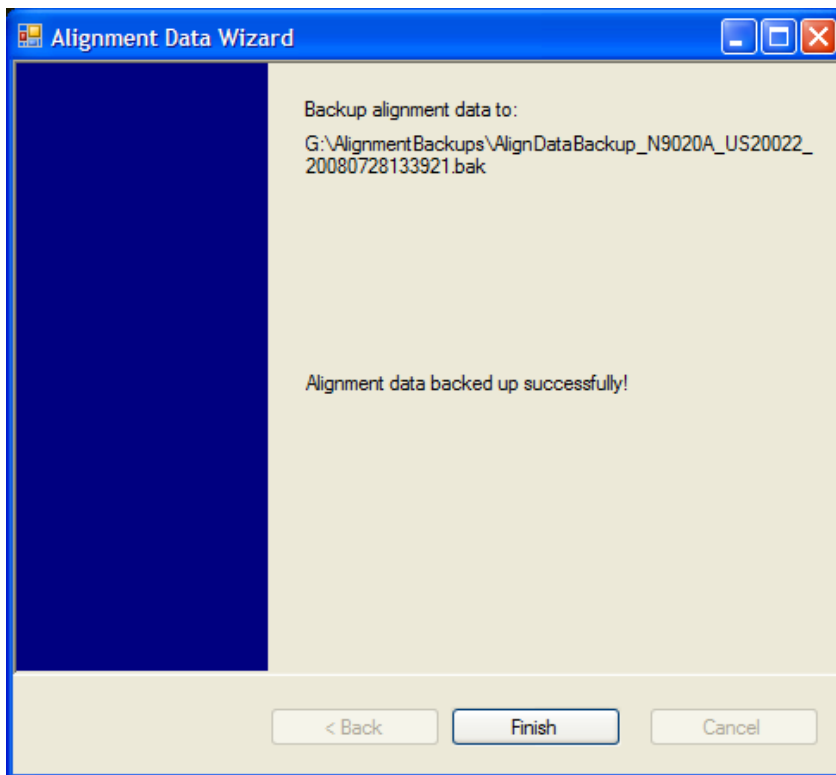
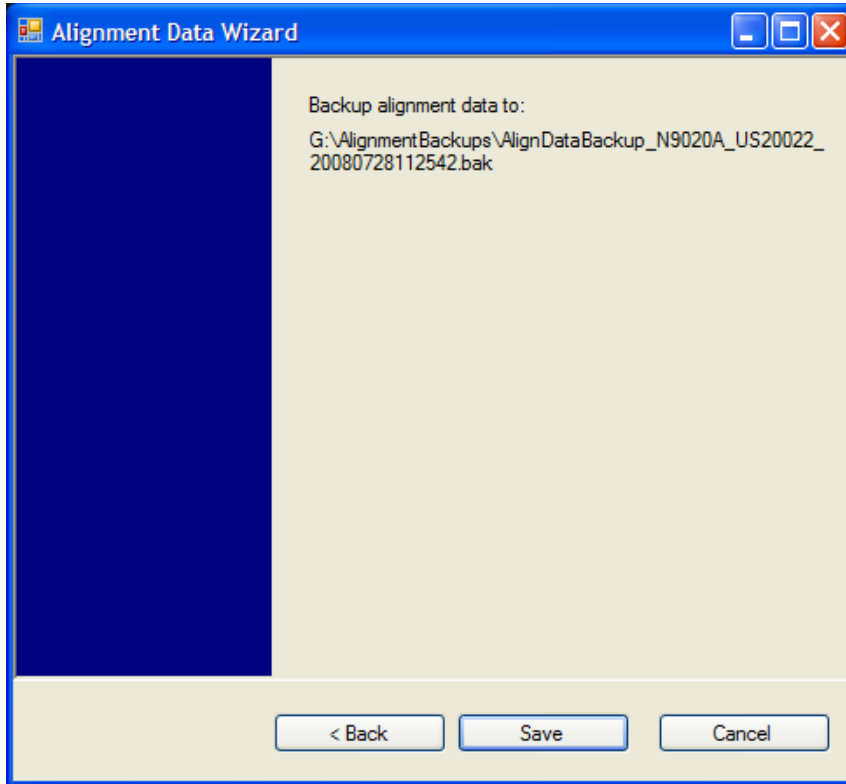

The restore operation will check the validity of the restore file using the database's built-in file validation. If the restore file is corrupt, the existing alignment data will remain in use.

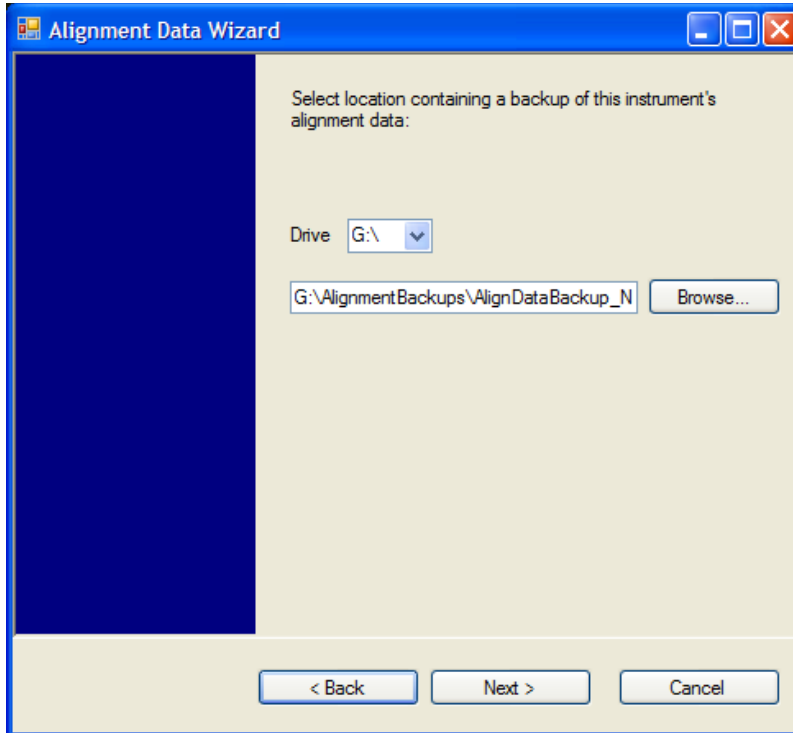

Changing the drive letter will also modify the path displayed in the box below. When this step is first loaded, the drive drop-down is populated with connected drives which provide you with read access. The path defaults to the AlignBackups folder. The most recent *.bak file in the folder will also be selected by default.

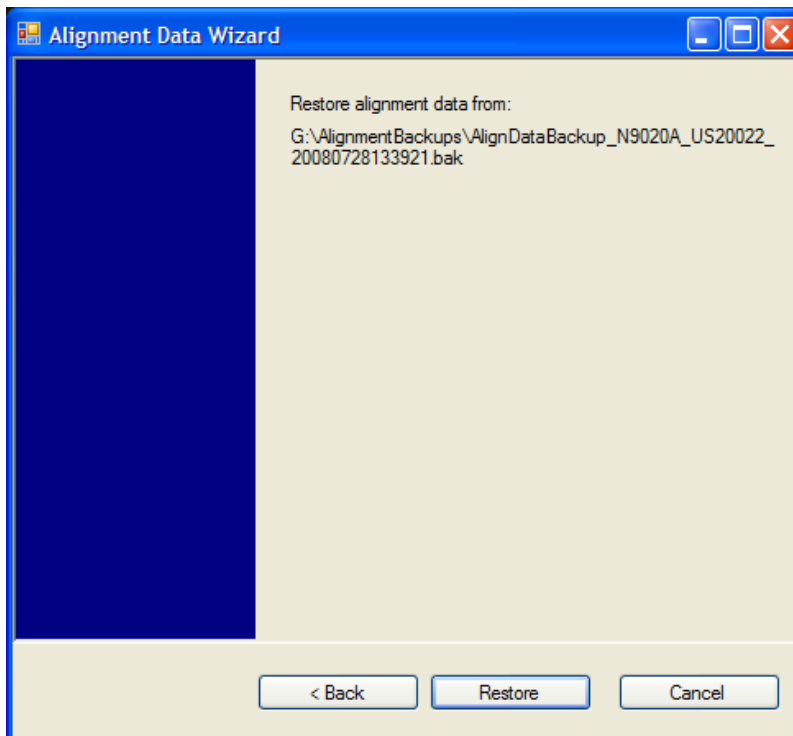

System Functions System

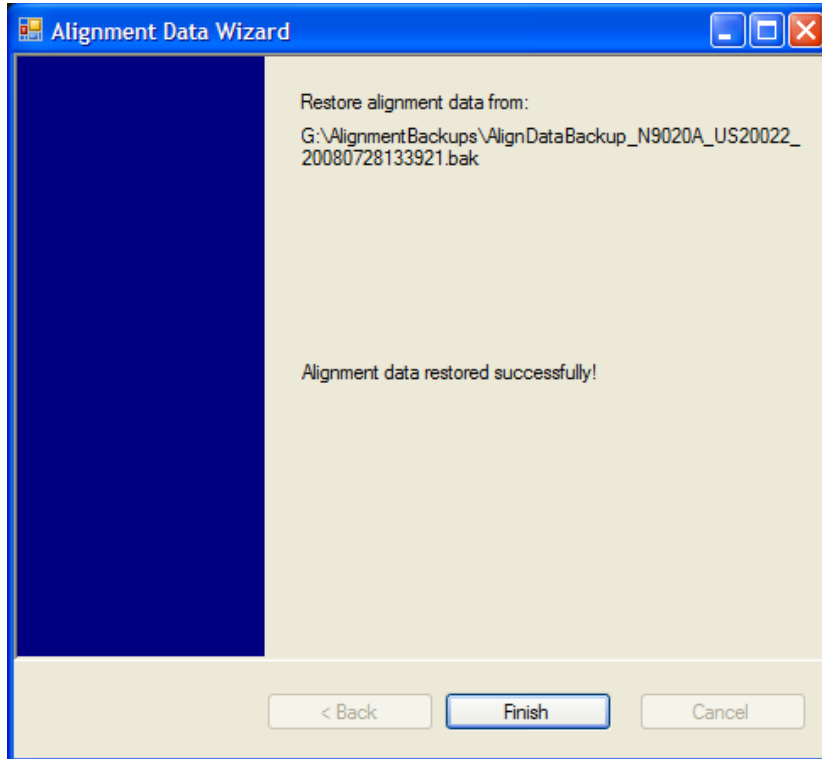

Perform Backup (Remote Command Only)

Invokes an alignment data backup operation to the provided Folder.

NOTE It is recommended that the Folder provided is outside of the instrument (USB or Mapped Network Drive).

Remote Command: :CALibration:DATA:BACKup <filename>

Example: :CAL:DATA:BACK
"F:\AlignDataBackup_N9020A_US00000001_2008140100.bak"

Instrument S/W Revision: A.02.00

Perform Restore (Remote Command Only)

Invokes an alignment data restore operation from the provided filename.

Remote Command: :CALibration:DATA:RESTore <filename>

Example: :CAL:DATA:REST "F:\
AlignDataBackup_N9020A_US00000001_2008140100.bak "

Instrument S/W Revision: A.02.00

I/O Config

Activates a menu for identifying and changing the I/O configuration for remote control.

Key Path	System
Instrument S/W Revision	Prior to A.02.00

GPIB

Activates a menu for configuring the GPIB I/O port.

Key Path	System, I/O Config
Instrument S/W Revision	A.02.00

GPIB Address

Selects the GPIB remote address.

Key Path	System, I/O Config, GPIB
Mode	All
Remote Command	:SYSTem:COMMunicate:GPIB[1] [:SELF] :ADDRESS <integer> :SYSTem:COMMunicate:GPIB[1] [:SELF] :ADDRESS?
Example	:SYST:COMM:GPIB:ADDR 17
Remote Command Notes	NOTE: Changing the Address on the GPIB port requires all further communication to use the new address.
Preset	This is unaffected by Preset but is set to 18 on a "Restore System Defaults->Misc"
State Saved	No
Range	0 to 30
Instrument S/W Revision	Prior to A.02.00

GPIB Controller

Sets the GPIB port into controller or device mode. In the normal state, GPIB controller is disabled, which allows the analyzer to be controlled by a remote computer. When GPIB Controller is enabled, the instrument can run software applications that use the instrument's computer as a GPIB controller; controlling devices connected to the instrument's GPIB port.

NOTE When GPIB Controller is enabled, the analyzer application itself cannot be controlled over GPIB; however, in this case it can easily be controlled via LAN or USB. The GPIB port cannot be a controller and device at the same time. Additionally, only one controller can be active on the GPIB bus at any given time; if the analyzer is the controller an external PC cannot be a controller.

To control the instrument from the software that is performing GPIB controller operation, you can use an internal TCP/IP connection to the analyzer application. Use the address TCPIP0::localhost::inst0::INSTR to send SCPI commands to the analyzer application.

Remote Command	:SYSTem:COMMunicate:GPIB [1] [:SELF] :CONTroller[:ENABle] ON OFF 0 1 :SYSTem:COMMunicate:GPIB [1] [:SELF] :CONTroller[:ENABle]?
Example	:SYST:COMM:GPIB:CONT ON Will set GPIB port to Controller
Key Path	System, I/O Config, GPIB
Mode	All
Scope	Mode Global
Notes	When the instrument becomes the Controller bit 0 in the Standard Event Status Register is set (and when the instrument relinquishes Controller capability bit 0 is cleared in the Standard Event Status Register).
Preset	This is unaffected by Preset but is set to OFF on a "Restore System Defaults->Misc"
State Saved	No
Range	Disabled Enabled
Instrument S/W Revision	A.02.00

Disabled

Selection for disabling the GPIB Controller capability, this is the default (or normal) setting.

Key Path	System, I/O Config, GPIB, GPIB Controller
Example	:SYST:COMM:GPIB:CONT OFF Will set GPIB port to Device
Instrument S/W Revision	A.02.00

Enabled

Selection for enabling the GPIB Controller capability.

Key Path	System, I/O Config, GPIB, GPIB Controller
Example	:SYST:COMM:GPIB:CONT ON Will set GPIB port to Controller
Instrument S/W Revision	A.02.00

SCPI LAN

Activates a menu for identifying and changing the SCPI over LAN configuration. There are a number of different ways to send SCPI remote commands to the instrument over LAN. It can be a problem to have multiple users simultaneously accessing the instrument over the LAN. These keys limit that somewhat by disabling the telnet, socket, and/or SICL capability.

Key Path	System, I/O Config
Instrument S/W Revision	Prior to A.02.00

SCPI Telnet

Turns the SCPI LAN telnet capability On or Off allowing you to limit SCPI access over LAN through telnet.

Key Path	System, I/O Config, SCPI LAN
Mode	All
Remote Command	:SYSTem:COMMunicate:LAN:SCPI:TELNet:ENABle OFF ON 0 1 :SYSTem:COMMunicate:LAN:SCPI:TELNet:ENABle?
Example	:SYST:COMM:LAN:SCPI:TELN:ENAB OFF
Preset	This is unaffected by Preset but is set to ON with a “Restore System Defaults->Misc”
State Saved	No
Range	On Off
Instrument S/W Revision	Prior to A.02.00

SCPI Socket

Turns the capability of establishing Socket LAN sessions On or Off. This allows you to limit SCPI access over LAN through socket sessions.

Key Path	System, I/O Config, SCPI LAN
Mode	All

System Functions System

Remote Command	:SYSTem:COMMunicate:LAN:SCPI:SOCKet:ENABle OFF ON 0 1 :SYSTem:COMMunicate:LAN:SCPI:SOCKet:ENABle?
Example	:SYST:COMM:LAN:SCPI:SOCK:ENAB OFF
Preset	This is unaffected by Preset but is set to ON with a “Restore System Defaults->Misc”
State Saved	No
Range	On Off
Instrument S/W Revision	Prior to A.02.00

SCPI Socket Control Port (Remote Command Only)

Returns the TCP/IP port number of the control socket associated with the SCPI socket session. This query enables you to obtain the unique port number to open when a device clear is to be sent to the instrument. Every time a connection is made to the SCPI socket, the instrument creates a peer control socket. The port number for this socket is random. You must use this command to obtain the port number of the control socket. To force a device clear on this socket, open the port and send the string “DCL” to the instrument.

If this SCPI command is sent to a non SCPI Socket interface, then 0 is returned.

Mode	All
Remote Command	:SYSTem:COMMunicate:LAN:SCPI:SOCKet:CONTRol?
Example	:SYST:COMM:LAN:SCPI:SOCK:CONT?
Preset	This is unaffected by Preset or “Restore System Defaults->Misc”.
State Saved	No
Range	0 to 65534
Instrument S/W Revision	Prior to A.02.00

SICL Server

Turns the SICL server capability On or Off, enabling you to limit SCPI access over LAN through the SICL server. (SICL IEEE 488.2 protocol.)

Parameter	Description	Setting
Maximum Connections	The maximum number of connections that can be accessed simultaneously	5
Instrument Name	The name (same as the remote SICL address) of your analyzer	inst0
Instrument Logical Unit	The unique integer assigned to your analyzer when using SICL LAN	8

Emulated GPIB Name	The name (same as the remote SICL address) of the device used when communicating with your analyzer	gpib7
Emulated GPIB Logical Unit	The unique integer assigned to your device when it is being controlled using SICL LAN	8
Emulated GPIB Address	The emulated GPIB address assigned to your transmitter tester when it is a SICL server (the same as your GPIB address)	18
Key Path	System, I/O Config, SCPI LAN	
Mode	All	
Remote Command	:SYSTem:COMMunicate:LAN:SCPI:SICL:ENABle OFF ON 0 1 :SYSTem:COMMunicate:LAN:SCPI:SICL:ENABle?	
Example	:SYST:COMM:LAN:SCPI:SICL:ENAB OFF	
Preset	This is unaffected by Preset, but is set to ON with a “Restore System Defaults->Misc”	
State Saved	No	
Range	On Off	
Instrument S/W Revision	Prior to A.02.00	

Reset Web Password

The embedded webserver contains certain capability which are password protected; modifying the LAN configuration of the instrument, and access to web pages that can change the settings of the instrument. The default password from the factory is `agilent` (without the quotes).

Selecting Reset web password brings up a control for resetting the password, or to the factory default. An external keyboard is required to change the password from the factory default of `agilent` or to set a new password that contains alphabetic characters. The control is:

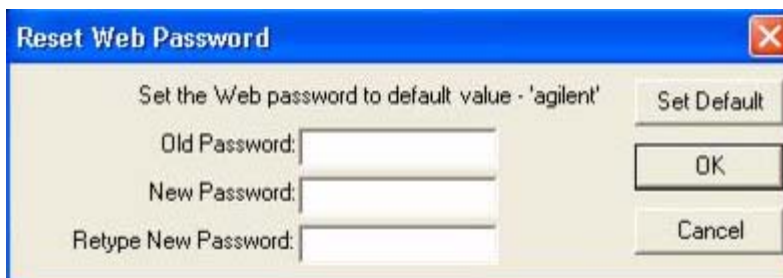

If this control is entered without an external keyboard or mouse connected, you can cancel the control by pressing the Cancel (ESC) front-panel key.

Mode	All
Key Path	System, I/O Config

System Functions System

Instrument S/W Revision Prior to A.02.00

Query USB Connection (Remote Command Only)

Enables you to determine the speed of USB connection.

Mode	All
Remote Command	:SYSTem:COMMunicate:USB:CONNecion?
Example	:SYST:COMM:USB:CONN?
Remote Command Notes	NONE – Indicates no USB connection has been made. LSPeed – Indicates a USB low speed connection (1.5 Mbps). Note: this is reserved for future use, the T+M488 protocol is not supported on low speed connections. HSPeed – Indicates that a USB high speed connection (480 Mbps) has been negotiated. FSPeed – Indicates that a USB full speed connection (12 Mbps) has been negotiated.
State Saved	No
Range	NONE LSPeed HSPeed FSPeed
Instrument S/W Revision	Prior to A.02.00

USB Connection Status (Remote Command Only)

Enables you to determine the current status of the USB connection.

Mode	All
Remote Command	:SYSTem:COMMunicate:USB:STATus?
Example	:SYST:COMM:USB:STAT?
Remote Command Notes	SUSPended – Indicates that the USB bus is currently in its suspended state. The bus is in the suspended state when: The bus is not connected to any controller The controller is currently powered off The controller has explicitly placed the USB device into the suspended state. When in the suspended state, no USB activity, including start of frame packets are received. ACTive – Indicates that the USB device is in the active state. When the device is in the active state, it is receiving periodic start of frames but it isn't necessarily receiving or transmitting data.
State Saved	No
Range	SUSPended ACTive

Instrument S/W Revision Prior to A.02.00

USB Packet Count (Remote Command Only)

Enables you to determine the number of packets received and transmitted on the USB bus.

Mode	All
Remote Command	:SYSTem:COMMunicate:USB:PACKets?
Example	:SYST:COMM:USB:PACK?
Remote Command Notes	Two integers are returned. The first is the number of packets received since application invocation, the second is the number of packets transmitted since application invocation. If no packets have been received or transmitted the response is 0,0. The packet count is initialized to 0,0 when the instrument application is started.
State Saved	No
Instrument S/W Revision	Prior to A.02.00

LXI

Pressing this key opens a menu that allows you to access the various LXI configuration properties.

Tip: For information about setting up measurements using LXI, refer to the "Programmer's Guide" located in your analyzer at: C:/Program Files/Agilent/Signal Analysis/Help/Bookfiles/x_series_prog.pdf. It is also available by selecting the "Additional Documentation" page of the Help.

Key Path	System, I/O Config
Instrument S/W Revision	Prior to A.02.00

LAN Reset

This key resets the LAN connection.

Key Path	System, I/O Config, LXI
Instrument S/W Revision	Prior to A.02.00

LXI Domain

The instrument only receives LXI LAN Events sent by members of the same LXI Domain. Conversely, LXI Output LAN Events sent by the instrument can only be received by members of the same LXI Domain. This is not the same as the IEEE 1588 domain (see ["Domain \(Remote Command Only\)"](#) on page 219 ["Domain \(Remote Command Only\)"](#) on page 219).

Key Path	System, I/O Config, LXI
----------	--------------------------------

System Functions

System

Remote Command	:LXI:EVENT:DOMain <intDomain> :LXI:EVENT:DOMain?
Example	:LXI:EVEN:DOM 128 :LXI:EVEN:DOM?
Preset	Not affected by a Preset. The default value of "0" can be restored by pressing Restore Defs, Input/Output Settings
State Saved	Saved in instrument state.
Range	0–255
Instrument S/W Revision	Prior to A.02.00

LXI Output LAN Events

The device can be configured to send LXI LAN Events as the instrument's state changes. Specifically, it can notify other devices as the status signals WaitingForTrigger, Sweeping, Measuring, OperationComplete, and Recalling transition. Additionally, Output LAN Events can be sent in response to the receipt of any of the Input LAN Events.

This is the entry point for the LXI Output LAN Event system. This key branches to a list of events that can be sent out on the LAN in response to instrument events.

Key Path	System, I/O Config, LXI
Instrument S/W Revision	Prior to A.02.00

Disable All

This command causes the Enable property of all members of the LXI Output LAN Event List to be set to OFF.

Key Path	System, I/O Config, LXI, LXI Output LAN Events
Remote Command	:LXI:EVENT[:OUTPut]:LAN:DISable:ALL
Example	:LXI:EVEN:LAN:DIS:ALL
Instrument S/W Revision	Prior to A.02.00

Output LAN Event List

This is the list of LXI Output LAN events that can be sent in response to an instrument event such as sweeping or waiting for a trigger. Each member of this list has a key in the LXI Output LAN Events panel. The list can grow and shrink in response to Add and Remove commands respectively. New pages must be added and removed automatically as the list size changes. Only the first 14 characters of an LXI Output LAN Event name are displayed on the key.

Key Path	System, I/O Config, LXI, LXI Output LAN Events
Remote Command	:LXI:EVENT[:OUTPut]:LAN:LIST?

Example	:LXI:EVEN:LAN:LIST? Returns the complete list of Output LAN Events which is, at minimum: “LAN0”, “LAN1”, “LAN2”, “LAN3”, “LAN4”, “LAN5”, “LAN6”, “LAN7”, “WaitingForTrigger”, “Measuring”, “Sweeping”, “OperationComplete”, “Recalling”
Preset	Not affected by a Preset. The default values can be restored by pressing Restore Defs, Input/Output Settings. Preset/Default values: “LAN0”, “LAN1”, “LAN2”, “LAN3”, “LAN4”, “LAN5”, “LAN6”, “LAN7”, “WaitingForTrigger”, “Measuring”, “Sweeping”, “OperationComplete”, “Recalling”
State Saved	Saved in instrument state.
Instrument S/W Revision	Prior to A.02.00

Add (Remote Command Only)

Adds the provided string to the list of possible LAN events to output as a response to instrument events. As new LAN events are added, keys are generated in the LXI Output LAN Events menu. New key panels are generated as the number of possible LAN events increases past a multiple of six, and the “More” keys are updated to reflect the new number of key panels in the LXI Output LAN Events menu.

Remote Command:	:LXI:EVENT[:OUTPut]:LAN:ADD “LANEVENT”
Example:	:LXI:EVEN:LAN:ADD “LANEVENT”
Restriction and Notes:	The maximum length of the string is 16 characters. Longer strings are concatenated and added to the LXI Output LAN Event list. No event is added if the LAN Event already exists.
State Saved:	No
Range:	Uppercase, Lowercase, Numeric, Symbol except for comma or semicolon
Instrument S/W Revision:	Prior to A.02.00

Remove (Remote Command Only)

Removes the provided string from the list of possible LAN events to output as a response to instrument events. As new LAN events are removed, keys are removed from the LXI Output LAN Events menu. Key panels are removed as the number of possible LAN events decreases past a multiple of six, and the “More” keys are updated to reflect the new number of key panels in the LXI Output LAN Events menu. Events from the default list cannot be removed.

Remote Command:	:LXI:EVENT[:OUTPut]:LAN:REMOve[:EVENT] “LANEVENT”
Example:	:LXI:EVEN:LAN:REM “LANEVENT”

System Functions

System

Restriction and Notes:	The maximum length of the string is 16 characters. Longer strings are concatenated and the resulting LAN Event is removed from the LXI Output LAN Event list. Nothing happens if the LAN event was not introduced using the Add command.
State Saved:	No
Range:	Uppercase, Lowercase, Numeric, Symbol
Instrument S/W Revision:	Prior to A.02.00

Remove All (Remote Command Only)

Clears the list of custom LAN events (those introduced using the Add command) that are available to output as a response to instrument events. As new LAN events are removed, keys are removed from the LXI Output LAN Events menu. Key panels are removed as the number of possible LAN events decreases past a multiple of six, and the “More” keys are updated to reflect the new number of key panels in the LXI Output LAN Events menu.

Remote Command:	:LXI:EVENT [:OUTPut] :LAN:REMOve:ALL
Example:	:LXI:EVEN:LAN:REM:ALL
Restriction and Notes:	Only LAN Events added with the Add command are removed. Default events cannot be removed.
Instrument S/W Revision:	Prior to A.02.00

Source

Sets the instrument event that this LXI Output LAN event is tied to.

The possible instrument events are “WaitingForTrigger”, “Sweeping”, “Measuring”, “OperationComplete”, and “Recalling”.

The key is labeled with the value of the selected source.

For the instrument event specific LXI Output LAN Events “WaitingForTrigger,” “Sweeping,” “Measuring,” “OperationComplete,” and “Recalling,” this parameter is set to the corresponding source value and cannot be changed. For these events, the Source key does not appear.

WaitingForTrigger, Measuring, and Sweeping correspond to the standard trigger state machine activities for which they are named.

OperationComplete is low when a measurement operation is underway. For example, OperationComplete is low throughout a list sweep measurement, even though Sweeping, Measuring, and WaitingForTrigger will undergo a number of transitions. In this case, OperationComplete goes high when the entire list sweep is finished.

Recalling is high while the instrument is actively recalling a state.

Additionally, the Source parameter can be set to the name of any Input LAN Event. This causes the Output LAN Event to be sent upon receipt of the named Input LAN Event. There is no front panel support for these events.

The default list of available Input LAN Events is:

- “LAN0”
- “LAN1”
- “LAN2”
- “LAN3”
- “LAN4”
- “LAN5”
- “LAN6”
- “LAN7”

Key Path	System, I/O Config, LXI, LXI Output LAN Events, LAN[n]
Remote Command	:LXI:EVENT[:OUTPut]:LAN[:SET]:SOURCE "LANEVENT", "SourceEvent" :LXI:EVENT[:OUTPut]:LAN[:SET]:SOURCE? "LANEVENT"
Example	:LXI:EVENT:LAN:SOUR "LANEVENT","WaitingForTrigger"
Restriction and Notes	The maximum length of the string is 45 characters.
Preset	Not affected by a Preset. The default values can be restored by pressing Restore Defs, Input/Output Settings. Preset/Default values: “Sweeping” (The Output LAN Events “WaitingForTrigger”, “Sweeping”, “Measuring”, “OperationComplete”, and “Recalling” all have default source parameters that match their names)
State Saved	Saved in instrument state.
Range	“WaitingForTrigger” “Sweeping” “Measuring” “OperationComplete” “Recalling” “LAN0” “LAN1” “LAN2” “LAN3” “LAN4” “LAN5” “LAN6” “LAN7” any user-added Input LAN Event
Instrument S/W Revision	Prior to A.02.00

Destination (Remote Command Only)

Outgoing LAN events are sent to the hosts enumerated in the destination expression. This expression takes the form of “host1:port1, host2:port2,...” where port numbers are optional, and default to the IANA assigned TCP port (5044). To designate a UDP broadcast at the default port, set the destination string to “” or “ALL”. To designate a UDP broadcast at a specific port, set the destination string to “:port” or “ALL:port”.

Examples:

- “192.168.0.1:23”
- “agilent.com, soco.agilent.com”

System Functions

System

- “agilent.com:80, 192.168.0.1”

Remote Command:	:LXI:EVENT[:OUTPut]:LAN[:SET]:DESTination “LANEVENT”, “destinationExpression” :LXI:EVENT[:OUTPut]:LAN[:SET]:DESTination? “LANEVENT”
Example:	:LXI:EVEN:LAN:DEST “LANEVENT”, “host1, 192.168.0.1:80”
Restriction and Notes:	The maximum length of the string is 45 characters.
Preset:	Not affected by a Preset. The default value of "ALL" can be restored by using the command: :SYSTem:DEFault INPut
State Saved:	Saved in instrument state.
Range:	Uppercase, Lowercase, Numeric, Symbol
Instrument S/W Revision:	Prior to A.02.00

Drive

Determines the behavior of an output event.

- Normal designates typical operation, where both edges of the instrument event are transmitted,
- Off disables the LAN event.
- Wired-OR causes only one edge to be transmitted.

Key Path	System, I/O Config, LXI, LXI Output LAN Events, LAN[n]
Remote Command	:LXI:EVENT[:OUTPut]:LAN[:SET]:DRIVE “LANEVENT”, OFF NORMal WOR :LXI:EVENT[:OUTPut]:LAN[:SET]:DRIVE? “LANEVENT”
Example	:LXI:EVEN:LAN:DRIV “LANEVENT”, WOR
Preset	Not affected by a Preset. The default value of "NORMal" can be restored by using the command: :SYSTem:DEFault INPut
State Saved	Saved in instrument state.
Range	OFF NORMal WOR
Instrument S/W Revision	Prior to A.02.00

Slope

Slope determines which instrument event transition results in a LAN packet being sent and whether or not that edge is inverted.

When the Drive parameter is set to Normal, a Slope of Negative causes both edges to be inverted before they are transmitted. A Positive Slope transmits the edges unaltered.

When the Drive parameter is set to WOR, only Positive edges are transmitted. When the Slope is Negative, a

falling edge is inverted and sent as a rising edge. When the Slope is Positive, a rising edge is sent normally. The following table illustrates the effects of the Slope and Drive parameters.

Instrument Event Edge	Slope Parameter	Drive Parameter	Action
0	Negative	Off	Not sent
0	Positive	Off	Not sent
1	Negative	Off	Not sent
1	Positive	Off	Not sent
0	Negative	Normal	1
0	Positive	Normal	0
1	Negative	Normal	0
1	Positive	Normal	1
0	Negative	Wired OR	1
0	Positive	Wired OR	Not sent
1	Negative	Wired OR	Not sent
1	Positive	Wired OR	0

Key Path	System, I/O Config, LXI, LXI Output LAN Events, LAN[n]
Remote Command	:LXI:EVENT[:OUTPut]:LAN[:SET]:SLOPe "LANEVENT", POSitive NEGative :LXI:EVENT[:OUTPut]:LAN[:SET]:SLOPe? "LANEVENT"
Example	:LXI:EVEN:LAN:SLOP "LANEVENT",POS
Preset	Not affected by a Preset. The default value of "Positive" can be restored by using the command: :SYSTem:DEFault INPut
State Saved	Saved in instrument state.
Range	POSitive NEGative
Instrument S/W Revision	Prior to A.02.00

Timestamp Delta

This parameter represents a time in seconds to add to the timestamp of the Output LAN Event. This timestamp delta allows the receiving instrument to delay its response until the time specified in the timestamp.

Key Path	System, I/O Config, LXI, LXI Output LAN Events, LAN[n]
----------	---

System Functions

System

Remote Command	<code>:LXI:EVENT[:OUTPut]:LAN[:SET]:TSDelta "LANEVENT" , <seconds></code> <code>:LXI:EVENT[:OUTPut]:LAN[:SET]:TSDelta? "LANEVENT"</code>
Example	<code>:LXI:EVEN:LAN:TSD "LANEVENT",10.5 s</code>
Preset	Not affected by a Preset. The default value of "0.0 s" can be restored by using the command: <code>:SYSTem:DEFault INPut</code>
State Saved	Saved in instrument state.
Range	0.0 – 1.7976931348623157 x 10308 s (Max Double)
Instrument S/W Revision	Prior to A.02.00

Enabled

If this parameter is set to ON, this LAN Event is sent when the selected Source instrument event occurs.

Otherwise, this LAN Event is never output.

Key Path	System, I/O Config, LXI, LXI Output LAN Events, LAN[n]
Remote Command	<code>:LXI:EVENT[:OUTPut]:LAN[:SET]:ENABLEd "LANEVENT" , ON OFF 1 0</code> <code>:LXI:EVENT[:OUTPut]:LAN[:SET]:ENABLEd? "LANEVENT"</code>
Example	<code>:LXI:EVEN:LAN:ENAB "LAN0",ON</code>
Preset	Not affected by a Preset. The default value of "OFF" can be restored by using the command: <code>:SYSTem:DEFault INPut</code>
State Saved	Saved in instrument state.
Range	OFF ON 0 1
Instrument S/W Revision	Prior to A.02.00

Count (Remote Command Only)

Returns the number of items in the LXI Output LAN Event List.

Remote Command:	<code>:LXI:EVENT[:OUTPut]:LAN:COUNT?</code>
Example:	<code>:LXI:EVEN:LAN:COUN?</code>
Instrument S/W Revision:	Prior to A.02.00

Configure (Remote Command Only)

Allows the configuration of some of the above parameters from a single SCPI command.

Remote Command: : LXI:EVENT[:OUTPut]:LAN[:SET]:CONFigure
 "lanEvent", <enabled>, <source>, <slope>, <drive>, <destination>

Example: : LXI:EVEN:LAN:CONF
 "LAN0",1,"WaitingForTrigger",POS,NORM,"ALL"

Instrument S/W Revision: Prior to A.02.00

Send (Remote Command Only)

Forces the instrument to send the requested LAN Event. The LAN Event must be enabled, otherwise this command is ignored.

Remote Command: : LXI:EVENT[:OUTPut]:LAN:SEND "LANEVENT" ", RISE|FALL

Example: : LXI:EVEN:LAN:SEND "LANEVENT", FALL

Instrument S/W Revision: Prior to A.02.00

Identifier (Remote Command Only)

Sets the string that will be placed in the peer-to-peer packet when the Output LAN Event is transmitted. The Identifier is variable to allow for easier system debugging. The Identifier must be unique, for example the "LAN0" and "LAN1" output events cannot have identical identifiers.

Remote Command: : LXI:EVENT[:OUTPut]:LAN[:SET]:IDENTifier "LANEVENT",
 "identifier"
 : LXI:EVENT[:OUTPut]:LAN[:SET]:IDENTifier? "LANEVENT"

Example: : LXI:EVEN:LAN:IDEN"LAN0","debugstring"

Restriction and Notes: The maximum length of the string is 16 characters.
 Nothing happens if the LAN event does not exist.
 The default value is that the identifier is equivalent to the name of the LAN Event.

State Saved: Saved in instrument state.

Range: Uppercase, Lowercase, Numeric, Symbol

Instrument S/W Revision: Prior to A.02.00

IEEE 1588 Time (Remote Command Only)

Time

Epoch Time (Remote Command Only)

If the device is selected as the IEEE 1588 master clock, this sets the clock using the number of seconds elapsed since January, 1 1970 at 00:00:00 in International Atomic Time (TAI). Epoch time is time zone invariant. Otherwise, this allows you to query the epoch time.

Remote Command: `:LXI:CLOCK[:TIME][:VALUE] <seconds>,<fractionalSeconds>`

Example: `:LXI:CLOC 10020304.0 s,0.123456 s`

Restriction and Notes: The seconds argument must only contain values representing whole seconds. For example 1243.0 s is acceptable, but 1243.01 results in an error.

Ignored when the device is not selected as the IEEE 1588 master clock.

The fractional portion is only accurate to the microseconds position.

Error generated if the seconds argument contains a fractional portion.

Preset: Not affected by a Preset. The default value of "System Time" can be restored by using the command:

`:SYSTEM:DEFAULT INPUT`

State Saved: No

Range: Seconds: 0.0 – 1.7976931348623157 x 10308 s (Max Double)

Fraction: 0.0 s – 0.999999 s

Instrument S/W Revision: Prior to A.02.00

Remote Command: `:LXI:CLOCK[:TIME][:VALUE]?`

Example: `:LXI:CLOC?`

Restriction and Notes: The seconds argument must only contain values representing whole seconds. For example 1243.0 s is acceptable, but 1243.01 results in an error.

Ignored when the device is not selected as the IEEE 1588 master clock.

The fractional portion is only accurate to the microseconds position.

Error generated if the seconds argument contains a fractional portion.

Preset: System time

State Saved: No

Range: Seconds: 0.0 – 1.7976931348623157 x 10308 s (Max Double)

Fraction: 0.0 s – 0.999999 s

Instrument S/W Revision: Prior to A.02.00

Seconds (Remote Command Only)

If the device is selected as the IEEE 1588 master clock, this sets the seconds portion of the clock. Otherwise, this allows you to query the seconds portion of the epoch time. Valid values are in discrete increments of whole seconds.

Remote Command:	:LXI:CLOCK[:TIME]:SECONDS <seconds> :LXI:CLOCK[:TIME]:SECONDS?
Example:	:LXI:CLOC:SEC 10020304.0
Restriction and Notes:	Ignored when the device is not selected as the IEEE 1588 master clock. Error generated if the argument contains a fractional portion. For example 1243.0 s is acceptable, but 1243.01 results in an error.
Preset:	Not affected by a Preset. The default value of "System Time" can be restored by using the command: :SYSTEM:DEFAULT INPUT
State Saved:	No
Range:	0.0 – 1.7976931348623157 x 10308 s (Max Double)
Instrument S/W Revision:	Prior to A.02.00

Fraction (Remote Command Only)

If the device is selected as the IEEE 1588 master clock, this sets the sub-second value of the clock. Otherwise, this allows you to query the sub-second value of the epoch time.

Remote Command:	:LXI:CLOCK[:TIME]:FRACTION <fraction> :LXI:CLOCK[:TIME]:FRACTION?
Example:	:LXI:CLOC:FRAC 10 ms
Restriction and Notes:	Ignored when the device is not selected as the IEEE 1588 master clock. Only accurate to the microseconds position.
Preset:	Sub-second value of system time
State Saved:	No
Range:	[0.0,1.0)
Instrument S/W Revision:	Prior to A.02.00

Local Time (Remote Command Only)

Returns the current local time formatted as a date time string.

Remote Command:	:LXI:CLOCK[:TIME]:LOCAL?
Example:	:LXI:CLOC:LOC? Returns "5/15/2007 6:23:34.123456"

System Functions System

Notes: LXI:CLOCK[:TIME]:LOCAL? Returns Any string constituting a valid date and time

Instrument S/W Revision: Prior to A.02.00

Leap Second Offset (Remote Command Only)

Enables you to set the leap second offset between the UTC and TAI time standards.

Remote Command: :LXI:CLOCK[:TIME]:LSOFFSET <integer>
:LXI:CLOCK[:TIME]:LSOFFSET?

Example: :LXI:CLOC:LSOF 55

Range: 0 – 2147483647 (Max Integer)

Instrument S/W Revision: Prior to A.02.00

International Atomic Time (Remote Command Only)

Retrieves the current time using the TAI format.

Remote Command: :LXI:CLOCK[:TIME]:TAI?

Example: :LXI:CLOC:TAI? "5/15/2007 6:23:34.123456"

Notes: :LXI:CLOCK[:TIME]:TAI? Returns Any string constituting a valid date and time

Instrument S/W Revision: Prior to A.02.00

Time Zone (Remote Command Only)

Retrieves the current local time zone as an offset in hours, minutes, and seconds from Greenwich Mean Time.

Remote Command: :LXI:CLOCK[:TIME]:TZON?

Example: :LXI:CLOC:TZON?

Notes: :LXI:CLOC:TZON? returns "01:00:00" if the current local time zone is 1 hour ahead from Greenwich Mean Time

Instrument S/W Revision: Prior to A.02.00

Daylight Savings (Remote Command Only)

Retrieves the current status of the Windows System setting for Daylight Savings Time. Whether or not daylight savings time is in effect influences the time zone parameter.

Remote Command: :LXI:CLOCK[:TIME]:DLSavings?

Example: :LXI:CLOC:DLS?

Notes: :LXI:CLOC:DLS? Returns 1 when Daylight Savings Time is On and 0 if the when Daylight Savings Time is Off

Instrument S/W Revision: Prior to A.02.00

Coordinated Universal Time (Remote Command Only)

Retrieves the current time using the UTC format.

Remote Command: :LXI:CLOCK[:TIME]:UTC?

Example: :LXI:CLOC:UTC? "5/15/2007 6:23:34.123456"

Notes: :LXI:CLOC:UTC? Returns Any string constituting a valid date and time

Instrument S/W Revision: Prior to A.02.00

Time Marker (Remote Command Only)

Records the PTP time as a marker that can later be measured against the current PTP time. Typical use is to time the length of a sequence of instrument operations. There are 9 available markers with indices 1 – 9.

Remote Command: :LXI:CLOCK[:TIME]:MARKer[1|2|3|4|5|6|7|8|9[:SET]]

Example: :LXI:CLOC:MARK1

:LXI:CLOC:MARK2

:LXI:CLOC:MARK3

:LXI:CLOC:MARK4

:LXI:CLOC:MARK5

:LXI:CLOC:MARK6

:LXI:CLOC:MARK7

:LXI:CLOC:MARK8

:LXI:CLOC:MARK9

:LXI:CLOC:MARK

Instrument S/W Revision: Prior to A.02.00

Time Marker Clear (Remote Command Only)

Clears the recorded PTP time marker used to measure against the current PTP time. There are 9 available markers with indices 1 – 9.

Remote Command: :LXI:CLOCK[:TIME]:MARKer[1|2|3|4|5|6|7|8|9]:CLEAR

Example: : LXI:CLOC:MARK1:CLEAR
 : LXI:CLOC:MARK2:CLEAR
 : LXI:CLOC:MARK3:CLEAR
 : LXI:CLOC:MARK4:CLEAR
 : LXI:CLOC:MARK5:CLEAR
 : LXI:CLOC:MARK6:CLEAR
 : LXI:CLOC:MARK7:CLEAR
 : LXI:CLOC:MARK8:CLEAR
 : LXI:CLOC:MARK9:CLEAR
 : LXI:CLOC:MARK:CLEAR

Instrument S/W Revision: Prior to A.02.00

Time Marker Delta (Remote Command Only)

Calculates and returns the delta time from the marker to the present PTP time. Also returns the seconds and sub-seconds portions of the start and end times. There are 9 available markers with indices 1 – 9.

Remote Command: : LXI : CLOCk [: TIME] : MARKer [1] | 2 | 3 | 4 | 5 | 6 | 7 | 8 | 9 : DELTa?

Example: : LXI:CLOC:MARK1:DELT? returns
 <deltaTime>,<startSeconds>,<startFractionalSeconds>,<endSeconds>,<endFractionalSeconds>
 : LXI:CLOC:MARK2:DELT?
 : LXI:CLOC:MARK3:DELT?
 : LXI:CLOC:MARK4:DELT?
 : LXI:CLOC:MARK5:DELT?
 : LXI:CLOC:MARK6:DELT?
 : LXI:CLOC:MARK7:DELT?
 : LXI:CLOC:MARK8:DELT?
 : LXI:CLOC:MARK9:DELT?
 : LXI:CLOC:MARK:DELT?

Notes: : LXI:CLOCk[:TIME]:MARKer[1]|2|3|4|5|6|7|8|9:DELTA? Returns a value between 0.0 – 1.7976931348623157 x 10308 s (Max Double)

Range: 0.0 – 1.7976931348623157 x 10308 s (Max Double)

Instrument S/W Revision: Prior to A.02.00

Measurement Data Timestamp (Remote Command Only)

Returns the beginning and ending times of the last measurement cycle. This command also returns the duration of the measurement cycle. These values correspond to the last rising and falling transition of the Measuring instrument event.

Remote Command: : LXI : CLOCk [: TIME] : MEASure [: DELTa] ?
 Example: : LXI: CLOC: MEAS? Returns 2.0,1145902.0,0.123456, ,1145904.0,0.123456
 Notes: : LXI: CLOCk[: TIME]: MARKer[1]|2|3|4|5|6|7|8|9: DELTa? Returns a value between 0.0 – 1.7976931348623157 x 10308 s (Max Double)
 Instrument S/W Revision: Prior to A.02.00

Clear Measurement Data Timestamp (Remote Command Only)

Forces the return values of the Measurement Data Timestamp to zero until the next measurement cycle occurs. This command need not be issued for the Measurement Data Timestamp to be refreshed.

Remote Command: : LXI : CLOCk [: TIME] : MEASure : CLear
 Example: : LXI: CLOC: MEAS: CLE
 Instrument S/W Revision: Prior to A.02.00

Precision Time Protocol

Precision Time Protocol, as defined by IEEE 1588, is a method for synchronizing the time across a network. Instruments participating in the PTP network can coordinate activities using this common time base.

Accuracy (Remote Command Only)

Sets the typical offset from the correct time that a user can expect from the instrument PTP clock. This parameter is used when the instrument is selected as the Master clock. It should be set along with the time when configuring a master clock.

The value should be chosen by judging how precisely the clock can be set to the exact TAI time and the accuracy and drift of the clock's underlying oscillator.

This is an input to the IEEE 1588 Best Master Clock algorithm.

Remote Command: : LXI : CLOCk : PTP : ACCuracy
 NS25 | NS100 | NS250 | NS1000 | NS2500 | US10 | US25 | US100 | US250 | US
 1000 | US2500 | MS10 | MS25 | MS100 | MS1000 | S10 | GT10S | UNKNown
 : LXI : CLOCk : PTP : ACCuracy?
 Example: : LXI: CLOC: PTP: ACC US25
 Preset: Not affected by a Preset. The default value of "GT10S" can be restored by using the command:
 SYSTem: DEFault INPut

System Functions System

Range: NS25|NS100|NS250|NS1000|NS2500|US10|US25|US100|US250|US1000|US2500|MS10|MS25|MS100|MS1000|S10|GT10S|UNKNown

Instrument S/W Revision: Prior to A.02.00

Announce Interval (Remote Command Only)

Sets the time in seconds between PTP announce packets. A shorter interval makes the system more responsive to changes in the master clock at the cost of network bandwidth and packet processing time. The announce interval should be constant across all the instruments in the network. The announce interval will be rounded to the nearest non-negative integer power of two, with a maximum value of 16.

Remote Command: :LXI:CLOCK:PTP:ANNounce:INTerval <interval>
:LXI:CLOCK:PTP:ANNounce:INTerval?

Example: :LXI:CLOC:PTP:ANN:INT 1

Preset: Not affected by a Preset. The default value of "4" can be restored by using the command:

SYSTem:DEFault INPut

Range: 1|2|4|8|16

Instrument S/W Revision: Prior to A.02.00

Announce Receipt Time Out (Remote Command Only)

Sets the number of announce intervals that the instrument waits to receive an announce packet while in the Slave or Listening. After this number of announce intervals, the instrument will transition to the Master state.

Remote Command: :LXI:CLOCK:PTP:ANNounce:RTOut <numberOfIntervals>
:LXI:CLOCK:PTP:ANNounce:RTOut?

Example: :LXI:CLOC:PTP:ANN:RTO 5

Preset: Not affected by a Preset. The default value of "3" can be restored by using the command:

SYSTem:DEFault INPut

Min: 2

Max: 10

Instrument S/W Revision: Prior to A.02.00

Clock Class (Remote Command Only)

Returns a ranking of master clock suitability relative to other clocks on the network. A lower value represents a more suitable clock.

Suitability is defined by the IEEE 1588 standard section 7.6.2.4

Remote Command: :LXI:CLOCK:PTP:CCLass?

Example: :LXI:CLOC:PTP:CCL?

Preset: Not affected by a Preset. The default value of "248" can be restored by using the command:
SYSTem:DEFault INPut

Min: 6

Max: 248

Instrument S/W Revision: Prior to A.02.00

Deviation (Remote Command Only)

Returns the standard deviation of the instrument's PTP time from the Grandmaster's PTP time.

Remote Command: :LXI:CLOCK:PTP:DEVIation?

Example: :LXI:CLOC:PTP:DEV?

Instrument S/W Revision: Prior to A.02.00

Domain (Remote Command Only)

The instrument synchronizes its clock only with other clocks in the same domain.

Remote Command: :LXI:CLOCK:PTP:DOMain <domainNumber>
:LXI:CLOCK:PTP:DOMain?

Example: :LXI:CLOC:PTP:DOM 0

Preset: Not affected by a Preset. The default value of "0" can be restored by using the command:
SYSTem:DEFault INPut

Min: 0

Max: 127

Instrument S/W Revision: Prior to A.02.00

Offset (Remote Command Only)

Returns the difference between the instrument clock PTP time and the Master clock PTP time.

Remote Command: :LXI:CLOCK:PTP:OFFSet?

Example: :LXI:CLOC:PTP:OFFS?

Range: 0.0 to $-1.7976931348623157 \times 10308$ s (Min Double)

Instrument S/W Revision: Prior to A.02.00

First Priority (Remote Command Only)

Setting this parameter overrides the IEEE 1588 Best Master Clock algorithm. If an instrument's First Priority parameter is smaller than all other clocks in its domain, it is chosen as the Master clock.

Remote Command: : LXI : CLOcK : PTP : PRIority : FIRSt <priority>
 : LXI : CLOcK : PTP : PRIority : FIRSt?

Example: : LXI : CLOC : PTP : PRI : FIRS 50

Preset: Not affected by a Preset. The default value of "128" can be restored by using the command:
 SYSTem : DEFault INPut

Min: 0

Max: 255

Instrument S/W Revision: Prior to A.02.00

Second Priority (Remote Command Only)

When two or more clocks are determined to be equally good by the Best Master Clock algorithm, the clock with the lowest Second Priority value is chosen to be the Master Clock.

Remote Command: : LXI : CLOcK : PTP : PRIority : SECond <priority>
 : LXI : CLOcK : PTP : PRIority : SECond?

Example: : LXI : CLOC : PTP : PRI : SEC 50

Preset: Not affected by a Preset. The default value of "128" can be restored by using the command:
 SYSTem : DEFault INPut

Min: 0

Max: 255

Instrument S/W Revision: Prior to A.02.00

State (Remote Command Only)

Returns the current state of the instrument's PTP clock as defined in the IEEE 1588 standard.

Remote Command: : LXI : CLOcK : PTP : STATe?

Example: : LXI : CLOC : PTP : STAT?

Range: INITializing|FAULty|DISAbled|LISTening|PREMaster|
 MASTer|PASSive|UNCalibrated|SLAVE

Instrument S/W Revision: Prior to A.02.00

Traceability (Remote Command Only)

Returns the quality of the instrument's PTP clock source of time when chosen as the Grand Master clock.

This parameter is used by the Best Master Clock algorithm.

Remote Command: : LXI : CLOCk : PTP : TRACeability?
 Example: : LXI : CLOC : PTP : TRAC?
 Range: ATOMIC|GPS|RADIO|PTP|NTP|HANDset|OTHer|OSCillator
 Instrument S/W Revision: Prior to A.02.00

Variance (Remote Command Only)

Returns the variance of the instrument's PTP clock time relative to the Master's PTP clock time.

Remote Command: : LXI : CLOCk : PTP : VARiance?
 Example: : LXI : CLOC : PTP : VAR?
 Range: 0.0 – 1.7976931348623157 x 10308 (Max Double)
 Instrument S/W Revision: Prior to A.02.00

Sync Interval (Remote Command Only)

Sets the rate at which PTP sync packets are transmitted when this instrument is acting as a Master PTP clock. The values must be integer powers of 2.

Remote Command: : LXI : CLOCk : PTP : SINTerval <seconds>
 Example: : LXI : CLOC : PTP : SINT 0.25s
 Preset: Not affected by a Preset. The default value of "1" can be restored by using the command:
 SYSTem:DEFault INPut
 Range: 0.0625s|0.125s|0.25s|0.5s|1s|2s
 Instrument S/W Revision: Prior to A.02.00

Remote Command: : LXI : CLOCk : PTP : SINTerval?
 Example: : LXI : CLOC : PTP : SINT?
 Preset: 1
 Range: 0.0625s|0.125s|0.25s|0.5s|1s|2s
 Instrument S/W Revision: Prior to A.02.00

Delay Request Interval (Remote Command Only)

This property is used by the master clock to specify the interval between delay request packets sent from the slave to the master clock. Slaves use a randomly-chosen interval, with mean equal to this property.

The value for this parameter must be an integer power of two.

Remote Command: : LXI : CLOcK : PTP : DRINterval <seconds>
Example: : LXI : CLOC : PTP : DRIN 15 ms
Preset: Not affected by a Preset. The default value of "8 s" can be restored by using the command:
 SYSTem : DEFault INPut
Range: 1 s | 2 s | 4 s | 8 s | 16 s | 32 s
Instrument S/W Revision: Prior to A.02.00

Remote Command: : LXI : CLOcK : PTP : DRINterval?
Example: : LXI : CLOC : PTP : DRIN 15 ms
Preset: 8 s
Min: 0.0 s
Max: $2^{32} = 4294967296$ s
Instrument S/W Revision: Prior to A.02.00

Grand Master

Accuracy (Remote Command Only)

Returns the relative accuracy of the Grand Master clock.

Remote Command: : LXI : CLOcK : PTP : GMAStEr : ACCuracy?
Example: : LXI : CLOC : PTP : GMAS : ACC? For example, this might return GT10S.
Range: 25NS|100NS|250NS|1US|2.5US|10US|25US|100US|250US|1MS|2.5MS|10MS|25MS|100MS|1S|10S|GT10S|UNKNown
Instrument S/W Revision: Prior to A.02.00

MAC Address (Remote Command Only)

Returns the Grand Master's MAC Address.

Remote Command: : LXI : CLOcK : PTP : GMAStEr : MADDress?
Example: : LXI : CLOC : PTP : GMAS : MADD? For example, this might return "00-00-50-1e-ca-ad".
Range: Uppercase, Lowercase, Numeric, Symbol

Instrument S/W Revision: Prior to A.02.00

Traceability (Remote Command Only)

Describes the quality of the Grand Master PTP clock's source of time.

Remote Command: :LXI:CLOCK:PTP:GMASter:TRACeability?

Example: :LXI:CLOC:PTP:GMAS:TRAC? For example, this might return OSC.

Range: ATOMIC|GPS|RADIO|PTP|NTP|HANDset|OTHer|OSCillator

Instrument S/W Revision: Prior to A.02.00

Master MAC Address (Remote Command Only)

Returns the Master's MAC Address.

Remote Command: :LXI:CLOCK:PTP:MASter:MADdress?

Example: :LXI:CLOC:PTP:MASt:MADD?

Range: Uppercase, Lowercase, Numeric, Symbol

Instrument S/W Revision: Prior to A.02.00

Servo Algorithm (Remote Command Only)

The Servo Algorithm parameters are considered advanced settings for tweaking IEEE 1588 performance.

Log (Remote Command Only)

The Servo Log records measurements of the offset between the instrument's PTP clock and the Master's PTP clock. It also records the packet travel time for Master-to-Slave and Slave-to-Master transactions.

Next (Remote Command Only)

Retrieves and removes the oldest entry from the Servo Log. The format for a servo log entry is as follows

Sample Index: integer representing entry order

Time Seconds: seconds portion of the entry timestamp

Time Fraction: sub-second portion of the entry timestamp

Offset Seconds: offset between the instrument's PTP clock and the Master's PTP clock

Average Delay Seconds: the average measured transmission delay

Master Delay Seconds: Master-to-Slave packet travel time

Slave Delay Seconds: Slave-to-Master packet travel time

Remote Command: :LXI:CLOCK:SALGorithm:LOG[:NEXT]?

System Functions System

Example: :LXI:CLOC:SALG:LOG?
Range: Uppercase, Lowercase, Numeric, Symbol
Instrument S/W Revision: Prior to A.02.00

Circular (Remote Command Only)

Sets the behavior for entries occurring while the Servo Log is full.

- If Circular is set to 1, incoming events overwrite the oldest events in the log.
- If Circular is set to 0, incoming events are discarded.

Remote Command: :LXI:CLOCK:SALGORITHM:LOG:CIRCULAR[:ENABLED] ON|OFF|0|1
:LXI:CLOCK:SALGORITHM:LOG:CIRCULAR[:ENABLED]?

Example: :LXI:CLOC:SALG:LOG:CIRC 1

Preset: Not affected by a Preset. The default value of "1" can be restored by using the command:

SYSTEM:DEFAULT INPUT

Range: ON|OFF|0|1

Instrument S/W Revision: Prior to A.02.00

Beginning Entry (Remote Command Only)

Sets or freezes the beginning entry of the log when in circular mode to the most recently added entry at the time of the command. This is so that the :LXI:EVENT:LOG:ENTRY? command has a reference entry for indexing individual entries in the log.

Remote Command: :LXI:CLOCK:SALGORITHM:LOG:CIRCULAR:FBENTRY

Example: LXI:CLOCK:SALG:LOG:CIRC:FBEN

Instrument S/W Revision: Prior to A.02.00

Clear (Remote Command Only)

Clears all entries from the Servo Log.

Remote Command: :LXI:CLOCK:SALGORITHM:LOG:CLEAR

Example: :LXI:CLOC:SALG:LOG:CLEAR

Instrument S/W Revision: Prior to A.02.00

Count (Remote Command Only)

Returns the number of unread entries in the Servo Log.

Remote Command: :LXI:CLOCK:SALGORITHM:LOG:COUNT?

Example: :LXI:CLOC:SALG:LOG:COUN?
 Range: 0 - IEEE 1588 Servo Log Size
 Instrument S/W Revision: Prior to A.02.00

Enabled (Remote Command Only) •

- When the Servo Log is disabled, no events are recorded.
- When it is enabled, the Servo Log is active.

Remote Command: :LXI:CLOCK:SALGORITHM:LOG:ENABLED ON|OFF|0|1
 :LXI:CLOCK:SALGORITHM:LOG:ENABLED?

Example: :LXI:CLOC:SALG:LOG:ENAB 1

Preset: Not affected by a Preset. The default value of "0" can be restored by using the command:

SYSTEM:DEFAULT INPUT

Range: ON|OFF|0|1

Instrument S/W Revision: Prior to A.02.00

Size (Remote Command Only)

Sets the maximum number of entries to store in the Servo Log.

Remote Command: :LXI:CLOCK:SALGORITHM:LOG:SIZE <maxLogEntries>
 :LXI:CLOCK:SALGORITHM:LOG:SIZE?

Example: :LXI:CLOC:SALG:LOG:SIZE 100

Preset: Not affected by a Preset. The default value of "256" can be restored by using the command:

SYSTEM:DEFAULT INPUT

Min: 0

Max: 1024

Instrument S/W Revision: Prior to A.02.00

All (Remote Command Only)

Non-destructively returns the entire contents of the Servo Log.

Remote Command: :LXI:CLOCK:SALGORITHM:LOG:ALL?

Example: :LXI:CLOC:SALG:LOG?

Range: Uppercase, Lowercase, Numeric, Symbol

Instrument S/W Revision: Prior to A.02.00

Specific Entry (Remote Command Only)

Non-destructively returns a specifically indexed entry from within the Servo Log.

Remote Command: : LXI : CLOCk : SALGorithm : LOG : ENTRy? <intIndex>
Example: : LXI : CLOC : SALG : LOG? 0 Returns the oldest entry in the Servo Log.
Example of result :
"1,1208978798,139644871,0.000000000,3.393600e+038,0.000000000,0.000
000000,0.000000000"
Range: Uppercase, Lowercase, Numeric, Symbol
Instrument S/W Revision: Prior to A.02.00

Statistics (Remote Command Only)

Returns the long-term statistics of the servo log that characterizes the performance of the instrument PTP clock's offset from the master PTP clock. The statistics include the following values:

- Number of samples (an integer)
- Mean offset (a double)
- Standard deviation of the offset (a double)
- Maximum offset (a double)
- Minimum offset (a double)

Remote Command: : LXI : CLOCk : SALGorithm : LOG : STATistics [: DATA] ?
Example: : LXI : CLOC : SALG : LOG : STAT? Example of result :
"3643,0.000000000,0.000000000,0.000000000,0.000000000"
Instrument S/W Revision: Prior to A.02.00

Clear Statistics (Remote Command Only)

Resets the long-term servo performance statistics.

Remote Command: : LXI : CLOCk : SALGorithm : LOG : STATistics : CLear
Example: : LXI : CLOC : SALG : LOG : STAT? Example of result :
"3643,0.000000000,0.000000000,0.000000000,0.000000000"
Instrument S/W Revision: Prior to A.02.00

Asymmetry (Remote Command Only)

Sets the difference in seconds between the Master-to-Slave packet travel time and the Slave-to-Master packet travel time.

Remote Command: : LXI : CLOCk : SALGorithm [: SET] : ASYMmetry <seconds>
: LXI : CLOCk : SALGorithm [: SET] : ASYMmetry?

Example: :LXI:CLOC:SALG:ASYM 15 ns

Preset: Not affected by a Preset. The default value of "0.0 s " can be restored by using the command:
SYSTem:DEFault INPut

Min: -1

Max: 1

Instrument S/W Revision: Prior to A.02.00

Coarse/Fine Threshold (Remote Command Only)

Determines when the PTP clock Servo algorithm uses the 'Fine' or 'Coarse' parameters for adjusting the instrument's PTP clock time. The threshold is measured against a running estimate of the servo variance.

Coarse mode causes a slave clock to converge with the master clock more quickly, but it is more sensitive to noise, while Fine mode filters out noise more effectively, but takes longer to converge.

Remote Command: :LXI:CLOCK:SALGorithm[:SET]:CFThreshold
<secondsSquared>
:LXI:CLOCK:SALGorithm[:SET]:CFThreshold?

Example: :LXI:CLOC:SALG:CFTH 0.25

Preset: Not affected by a Preset. The default value of "1.0e-11 " can be restored by using the command:
SYSTem:DEFault INPut

Min: 0

Max: 1

Instrument S/W Revision: Prior to A.02.00

Coarse Proportional Constant (Remote Command Only)

This constant is used by the servo when above the Coarse/Fine Threshold variance. Decreasing this constant causes the servo to become less responsive to both noise in the system and changes in the Master Clock's rate. Conversely, increasing this constant causes the servo to respond more energetically to both system noise and changes in the Master Clock's rate.

The ratio between the Proportional and Integral constants should remain roughly constant.

Remote Command: :LXI:CLOCK:SALGorithm[:SET]:CPConstant <servoConstant>
:LXI:CLOCK:SALGorithm[:SET]:CPConstant?

Example: :LXI:CLOC:SALG:CPC 0.5

Preset: Not affected by a Preset. The default value of "0.4 " can be restored by using the command:
SYSTem:DEFault INPut

System Functions System

Min: 0
Max: 1
Instrument S/W Revision: Prior to A.02.00

Coarse Integral Constant (Remote Command Only)

This constant is used by the servo when above the Coarse/Fine Threshold variance. Decreasing this constant causes the servo to become less responsive to both noise in the system and changes in the Master Clock's rate. Conversely, increasing this constant causes the servo to respond more energetically to both system noise and changes in the Master Clock's rate.

The ratio between the Proportional and Integral constants should remain roughly constant.

Remote Command: :LXI:CLOCK:SALGORITHM[:SET]:CICConstant <servoConstant>
:LXI:CLOCK:SALGORITHM[:SET]:CICConstant?

Example: :LXI:CLOCK:SALG:CIC 0.5

Preset: Not affected by a Preset. The default value of "0.2 " can be restored by using the command:
SYSTEM:DEFAULT INPUT

Min: 0
Max: 1
Instrument S/W Revision: Prior to A.02.00

Fine Proportional Constant (Remote Command Only)

This constant is used by the servo when below the Coarse/Fine Threshold variance. Decreasing this constant causes the servo to become less responsive to both noise in the system and changes in the Master Clock's rate. Conversely, increasing this constant causes the servo to respond more energetically to both system noise and changes in the Master Clock's rate.

The ratio between the Proportional and Integral constants should remain roughly constant.

Remote Command: :LXI:CLOCK:SALGORITHM[:SET]:FPCConstant <servoConstant>
:LXI:CLOCK:SALGORITHM[:SET]:FPCConstant?

Example: :LXI:CLOCK:SALG:FPC 1

Preset: Not affected by a Preset. The default value of "0.35 " can be restored by using the command:
SYSTEM:DEFAULT INPUT

Min: 0
Max: 1
Instrument S/W Revision: Prior to A.02.00

Fine Integral Constant (Remote Command Only)

This constant is used by the servo when below the Coarse/Fine Threshold variance. Decreasing this constant causes the servo to become less responsive to both noise in the system and changes in the Master Clock's rate. Conversely, increasing this constant causes the servo to respond more energetically to both system noise and changes in the Master Clock's rate.

The ratio between the Proportional and Integral constants should remain roughly constant.

Remote Command: : LXI: CLOcK: SALGorithm[:SET] : FIConstant <servoConstant>
 : LXI: CLOcK: SALGorithm[:SET] : FIConstant?

Example: : LXI: CLOC: SALG: FIC 0.6

Preset: Not affected by a Preset. The default value of "0.05" can be restored by using the command:
 SYSTem: DEFault INPut

Min: 0

Max: 1

Instrument S/W Revision: Prior to A.02.00

Maximum Outlier Discard Count (Remote Command Only)

Sets the maximum number of outlier packets to ignore. After this maximum is exceeded, the next packet is accepted, regardless of whether or not it is flagged as an outlier.

Remote Command: : LXI: CLOcK: SALGorithm[:SET] : OMAXimum
 <consecutiveSamples>
 : LXI: CLOcK: SALGorithm[:SET] : OMAXimum?

Example: : LXI: CLOC: SALG: OMAX 3

Preset: Not affected by a Preset. The default value of "5" can be restored by using the command:
 SYSTem: DEFault INPut

Min: 0

Max: 25

Instrument S/W Revision: Prior to A.02.00

Outlier Threshold (Remote Command Only)

Defines the threshold for determining whether a packet is considered a statistical outlier. If a sync or delay request is held up in a switch for a significant amount of time, the quality of synchronization will be perturbed. The servo ignores anything outside the outlier threshold. This parameter is expressed as a number of standard deviations from the currently measured average packet latency. Note that the value can be set to fractional standard deviations.

Remote Command: :`LXI:CLOCK:SALGorithm[:SET]:OTHreshold`
 :`<standardDeviations>`
 :`LXI:CLOCK:SALGorithm[:SET]:OTHreshold?`

Example: :`LXI:CLOC:SALG:OTHR 1.0`

Preset: Not affected by a Preset. The default value of "5.0" can be restored by using the command:
`SYSTem:DEFault INPut`

Min: 0.25

Max: 6.0

Instrument S/W Revision: Prior to A.02.00

Outlier Threshold Enable (Remote Command Only)

Enables the outlier threshold to determine whether or not outliers are discarded.

Remote Command: :`LXI:CLOCK:SALGorithm[:SET]:OTENable ON|OFF|1|0`
 :`LXI:CLOCK:SALGorithm[:SET]:OTENable?`

Example: :`LXI:CLOC:SALG:OTEN OFF`

Preset: Not affected by a Preset. The default value of "OFF" can be restored by using the command:
`SYSTem:DEFault INPut`

Instrument S/W Revision: Prior to A.02.00

Set/Steer Threshold (Remote Command Only) I

If the instrument's clock deviates from the master by an amount equal to or greater than this threshold, it is reset to match the master rather than being gradually steered toward it.

Remote Command: :`LXI:CLOCK:SALGorithm[:SET]:STHreshold <seconds>`
 :`LXI:CLOCK:SALGorithm[:SET]:STHreshold?`

Example: :`LXI:CLOC:SALG:STHR 15 ms`

Preset: Not affected by a Preset. The default value of "0.1 s" can be restored by using the command:
`SYSTem:DEFault INPut`

Min: 0.0001

Max: 10.0
Instrument S/W Revision: Prior to A.02.00

Configure (Remote Command Only)

Allows the configuration of some of the above parameters from a single SCPI command.

Remote Command: :LXI:CLOCK:SALGorithm[:SET]:CONFigure <asymmetry>, <coarse fine threshold>, <cpc>, <cic>, <fpc>, <fic>, <maximum outlier discard>, <outlier threshold>, <set/steer threshold>
Example: :LXI:CLOC:SALG:CONF 0.0, 2.0E-13, 0.4, 0.2, 0.35, 0.05, 5, 2.0E-4, 0.1s
Instrument S/W Revision: Prior to A.02.00

Synchronization (Remote Command Only)

Master (Remote Command Only)

Reports whether or not the device has been selected as the PTP master clock.

Remote Command: :LXI:CLOCK:SYNC:MASTer?
Example: :LXI:CLOC:SYNC:MAST?
Range: ON|OFF|0|1
Instrument S/W Revision: Prior to A.02.00

Local Enabled (Remote Command Only)

Enable steering of the local clock with the PTP IEEE 1588 clock.

Remote Command: :LXI:CLOCK:SYNC:LOCAL:ENABled ON|OFF|0|1
:LXI:CLOCK:SYNC:LOCAL:ENABled?
Example: :LXI:CLOC:SYNC:LOC:ENAB ON
Preset: Not affected by a Preset. The default value of "ON" can be restored by using the command:
SYSTem:DEFault INPut
Range: ON|OFF|0|1
Instrument S/W Revision: Prior to A.02.00

Local Interval (Remote Command Only)

The local clock is updated after the time set in the Local Interval elapses.

Remote Command:	:LXI:CLOCK:SYNC:LOCAL:INTERVAL :LXI:CLOCK:SYNC:LOCAL:INTERVAL?
Example:	:LXI:CLOC:SYNC:LOC:INT 60
Preset:	Not affected by a Preset. The default value of "60 " can be restored by using the command: SYSTem:DEFault INPut
Min:	0
Max:	3600
Instrument S/W Revision:	Prior to A.02.00

Instrument Status Events

Enable (Remote Command Only)

Setting the enabled parameter to ON enables the selected instrument event to be used as a source for Output LAN Events. Enabling an Instrument Status Event also causes the event to appear in the Event Log.

Remote Command:	:LXI:EVENT:STATUS[:ENABLED] "STATUSEVENT",ON OFF 1 0
Example:	:LXI:EVEN:STAT "WaitingForTrigger",1
Preset:	Not affected by a Preset. The default value of "1" can be restored by using the command, :SYSTem:DEFault INPut.
State Saved:	Saved in instrument state.
Range:	1 0 ON OFF
Instrument S/W Revision:	Prior to A.02.00

Remote Command:	:LXI:EVENT:STATUS[:ENABLED]? "STATUSEVENT"
Example:	:LXI:EVEN:STAT? "WaitingForTrigger" Returns 1 if previously enabled. Otherwise, returns 0.
Preset:	ON
State Saved:	Saved in instrument state.
Range:	1 0 ON OFF
Instrument S/W Revision:	Prior to A.02.00

LXI State Recall

Location (Remote Command Only)

This parameter is used to store the file paths of the state files to be recalled when each Input LAN Event is received. Since each LAN Event has its own Location entry, a given state is capable of branching to at least 8 different states. If custom Input events are added, an even greater branching factor is possible.

When setting up state transitions, it is important to set the location of the next state before saving. This way, when the saved state is recalled, the n

ext state locations are also automatically recalled.

Remote Command:	:LXI:EVENT:INPut:LAN:LOCation "LANEVENT", "path"
Example:	:LXI:EVEN:INP:LAN:LOC "LANEVENT", "c:\states\state01.state"
Restriction and Notes:	The maximum length of the string is 512 characters.
State Saved:	Saved in instrument state.
Range:	Uppercase, Lowercase, Numeric, Symbol
Instrument S/W Revision:	Prior to A.02.00

Remote Command:	:LXI:EVENT:INPut:LAN:LOCation? "LANEVENT"
Example:	:LXI:EVEN:INP:LAN:LOC? "LANEVENT" Returns "c:\states\state01.state" if that value was previously entered
Restriction and Notes:	The maximum length of the string is 512 characters.
State Saved:	Saved in instrument state.
Range:	Uppercase, Lowercase, Numeric, Symbol
Instrument S/W Revision:	Prior to A.02.00

Disable All (Remote Command Only)

Causes all LXI Input LAN Events to go into the disabled state (Enabled = OFF).

Remote Command:	:LXI:EVENT:INPut:LAN:DISable:ALL
Example:	:LXI:EVEN:INP:LAN:DIS:ALL
Instrument S/W Revision:	Prior to A.02.00

Add (Remote Command Only)

Adds the provided string to the list of possible LAN events to Input as a response to instrument events. As new LAN events are added, keys are generated in the LXI Input LAN Events menu. New key panels are generated as the number of possible LAN events increases past a multiple of six, and the "More"

keys are updated to reflect the new number of key panels in the LXI Input LAN Events menu.

Remote Command:	:LXI:EVENT:INPut:LAN:ADD "LANEVENT"
Example:	:LXI:EVEN:INP:LAN:ADD "LANEVENT"
Restriction and Notes:	The maximum length of the string is 16 characters. Longer strings are concatenated and added to the LXI Input LAN Event list. No event is added if the LAN Event already exists.
State Saved:	No
Range:	Uppercase, Lowercase, Numeric, Symbol except for comma or semicolon
Instrument S/W Revision:	Prior to A.02.00

Remove (Remote Command Only)

Removes the provided string from the list of LXI Input LAN Events. As new LAN events are removed, keys are removed from the LXI Input LAN Events menu. Key panels are removed as the number of possible LAN events decreases past a multiple of six, and the "More" keys are updated to reflect the new number of key panels in the LXI Input LAN Events menu. Events from the default list cannot be removed.

Remote Command:	:LXI:EVENT:INPut:LAN:REMOve [:EVENT] "LANEVENT"
Example:	:LXI:EVEN:INP:LAN:REM "LANEVENT"
Restriction and Notes:	The maximum length of the string is 16 characters. Longer strings are concatenated and the resulting LAN Event is removed from the LXI Input LAN Event list. Nothing happens if the LAN event was not introduced using the Add command.
State Saved:	No
Range:	Uppercase, Lowercase, Numeric, Symbol
Instrument S/W Revision:	Prior to A.02.00

Remove All (Remote Command Only)

Clears the list of custom LAN events (those introduced using the Add command). As new LAN events are removed, keys are removed from the LXI Input LAN Events menu. Key panels are removed as the number of possible LAN events decreases past a multiple of six, and the "More" keys are updated to reflect the new number of key panels in the LXI Input LAN Events menu.

Remote Command:	:LXI:EVENT:INPut:LAN:REMOve:ALL
Example:	:LXI:EVEN:INP:LAN:REM:ALL
Restriction and Notes:	Only LAN Events added with the Add command are removed. Default events cannot be removed.

Instrument S/W Revision: Prior to A.02.00

Filter (Remote Command Only)

Only LXI Input LAN Events coming from hosts matching the filter string are processed. There is no Key Path to this command

The syntax for specifying a filter is as follows:

Filter == ([host[:port]] | [ALL[:port]]) [,Filter]

Specifying an empty string means that LXI trigger packets are accepted as an Input from any port on any host on the network via either TCP or UDP.

Specifying only the port means that any host communicating over that port can send events.

Specifying ALL indicates that UDP multicast packets are accepted if they are directed to the IANA assigned multicast address on the IANA assigned default port, or the designated port if specified.

Examples:

- “192.168.0.1:23”
- “agilent.com, soco.agilent.com”
- “agilent.com:80, 192.168.0.1”

Remote Command: :LXI:EVENT:INPut:LAN:FILTer “LANEVENT”, “filterString”
:LXI:EVENT:INPut:LAN:FILTer?

Example: :LXI:EVEN:INP:LAN:FILT “LAN0”, “agilent.com”
:LXI:EVEN:INP:LAN:FILT?

Restriction and Notes: The maximum length of the string is 45 characters. Nothing happens if the LAN event does not exist.

State Saved: Saved in instrument state.

Range: Uppercase, Lowercase, Numeric, Symbol

Instrument S/W Revision: Prior to A.02.00

Identifier (Remote Command Only)

Sets the string that is expected to arrive over the LAN for a given Input LAN Event to occur. The Identifier is variable to allow for easier system debugging.

Remote Command: :LXI:EVENT:INPut:LAN:IDENtifier “LANEVENT”, “identifier”
:LXI:EVENT:INPut:LAN:IDENtifier? “LANEVENT”

Example: :LXI:EVEN:INP:LAN:IDEN “LAN0”, “debugstring”

System Functions

System

Restriction and Notes:	The maximum length of the string is 16 characters. Nothing happens if the LAN event does not exist. The default value is that the identifier is equivalent to the name of the LAN Event.
State Saved:	Saved in instrument state.
Range:	Uppercase, Lowercase, Numeric, Symbol
Instrument S/W Revision:	Prior to A.02.00

Detection (Remote Command Only)

Pressing this button brings up the Detection menu.

- Selecting “Rise” causes the instrument to trigger on the receipt of a signal low LAN Event followed by a signal high LAN Event.
- Selecting “Fall” causes the instrument to trigger on the receipt of a signal high LAN Event followed by a signal low LAN Event.
- Selecting “High” causes the instrument to trigger on every signal high LAN Event.
- Selecting “Low” causes the instrument to trigger on every signal low LAN Event.

Remote Command:	<code>:LXI:EVENT:INPut:LAN[:SET]:DETection "LANEVENT", HIGH LOW RISE FALL</code>
Example:	<code>:LXI:EVENT:INP:LAN:DET "LANEVENT",HIGH</code>
Restriction and Notes:	If a non existent LAN event is passed in the lanEvent argument, the command is ignored
Preset:	Not affected by a Preset. The default value of "HIGH" can be restored by using the remote command: <code>:SYSTem:DEFault INPut</code>
State Saved:	Saved in instrument state.
Range:	HIGH LOW RISE FALL
Instrument S/W Revision:	Prior to A.02.00

Remote Command:	<code>:LXI:EVENT:INPut:LAN[:SET]:DETection? "LANEVENT"</code>
Example:	<code>:LXI:EVEN:INP:LAN:DET? "LANEVENT"</code>
Restriction and Notes:	If a non existent LAN event is passed in the lanEvent argument, the command is ignored
Preset:	HIGH
State Saved:	Saved in instrument state.
Range:	HIGH LOW RISE FALL

Instrument S/W Revision: Prior to A.02.00

Enabled (Remote Command Only)

When the Enabled parameter is set to ON, receiving the given LAN Event causes the instrument to transition to the state held in the Next State Slot.

When the Enabled parameter is OFF, the Input LAN Event is ignored.

Remote Command: :LXI:EVENT:INPut:LAN[:SET]:ENABled
"LANEVENT", ON|OFF|1|0

Example: :LXI:EVEN:INP:LAN:ENAB "LAN0",1

Preset: Not affected by a Preset. The default value of "OFF" can be restored by using the remote command:

:SYSTem:DEFault INPut

State Saved: Saved in instrument state.

Range: 1|0

Instrument S/W Revision: Prior to A.02.00

Remote Command: :LXI:EVENT:INPut:LAN[:SET]:ENABled? "LANEVENT"

Example: :LXI:EVEN:INP:LAN:ENAB? "LAN0"

Preset: OFF

State Saved: Saved in instrument state.

Range: 1|0

Instrument S/W Revision: Prior to A.02.00

Count (Remote Command Only)

Returns the number of items in the LXI Input LAN Event List.

Remote Command: :LXI:EVENT:INPut:LAN:COUNT?

Example: :LXI:EVEN:INP:LAN:COUN?

Instrument S/W Revision: Prior to A.02.00

List (Remote Command Only)

Returns a list of all of the valid LXI Input LAN Event names.

Remote Command: :LXI:EVENT:INPut:LAN:LIST?

System Functions

System

Example:	:LXI:EVENT:INP:LAN:LIST? Returns "LAN0", "LAN1", "LAN2", "LAN3", "LAN4", "LAN5", "LAN6", "LAN7"
Preset:	"LAN0", "LAN1", "LAN2", "LAN3", "LAN4", "LAN5", "LAN6", "LAN7"
State Saved:	Saved in instrument state.
Instrument S/W Revision:	Prior to A.02.00

Configure (Remote Command Only)

Allows the configuration of some of the above parameters from a single SCPI command.

Remote Command:	:LXI:EVENT:INP:LAN[:SET]:CONFigure "lanEvent", <enab>, <detection>, <filter>, <identifier>
Example:	:LXI:EVENT:INP:LAN:CONF "LAN0",1,FALL,"FILTER","DEBUG"
Instrument S/W Revision:	Prior to A.02.00

Restore Defaults

Provides incremental initialization of the system setting groups along with supporting a comprehensive reset of the entire instrument back to a factory default state. The menu selections are the groups of system settings and when one is selected, that particular group of system settings is reset back to their default values.

Key Path	System
Mode	All
Remote Command	:SYSTem:DEFault [ALL] ALIGn INPut MISC MODes PON
Example	SYST:DEF
State Saved	No
Instrument S/W Revision	Prior to A.02.00

Restore Input/Output Defaults

Causes the group of settings and data associated with Input/Output front-panel key to be a reset to their default values. This level of Restore System Defaults does not affect any other system settings, mode settings and does not cause a mode switch.

Confirmation is required to restore the Input/Output setting. The confirmation dialog is:

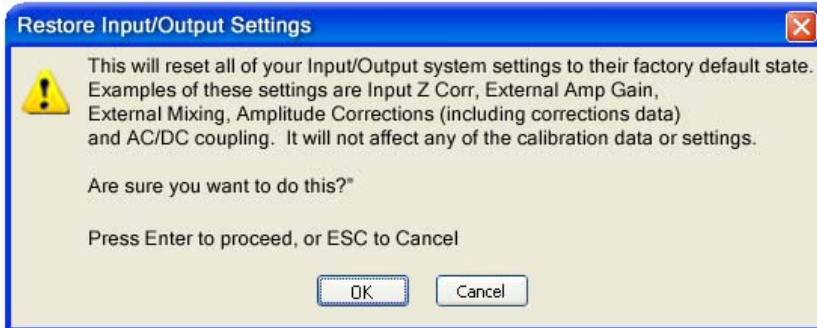

Key Path	System, Restore System Defaults
Example	:SYST:DEF INP
Instrument S/W Revision	Prior to A.02.00

Restore Power On Defaults

This selection causes the Power On settings to be a reset to their default value. This level of Restore System Defaults does not affect any other system settings, mode settings and does not cause a mode switch. The Power On settings and their default values are Power On Type reset to Mode and Input/Output Defaults and Power On Application reset to whatever the factory set as its default value.

Confirmation is required to restore the factory default values. The confirmation dialog is:

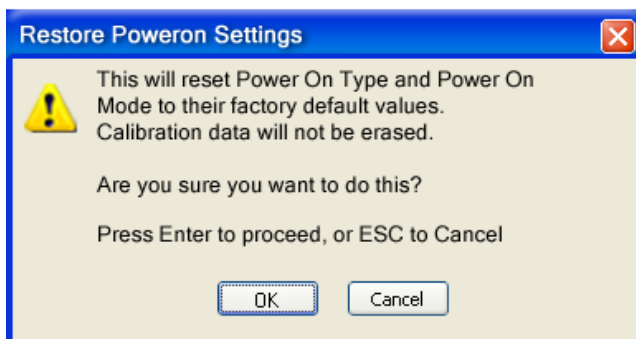

Key Path	System, Restore System Defaults
Example	:SYST:DEF PON
Instrument S/W Revision	Prior to A.02.00

Restore Align Defaults

This selection causes the Alignment system settings to be a reset to their default values. This does not affect any Alignment data stored in the system. This level of Restore System Defaults does not affect any other system settings, mode settings and does not cause a mode switch.

After performing this function, it may impact the auto-alignment time of the instrument until a new alignment baseline has been established.

Confirmation is required to restore the factory default values. The confirmation dialog is:

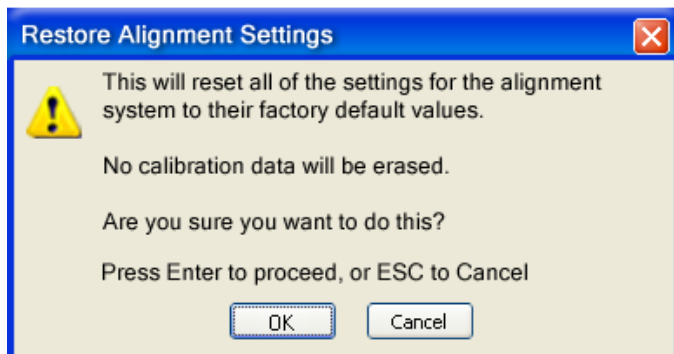

Key Path	System, Restore System Defaults
Example	:SYST:DEF ALIG
Instrument S/W Revision	Prior to A.02.00

Restore Misc Defaults

This selection causes miscellaneous system settings to be reset to their default values. With this reset, you lose the GPIB address and it is reset to 18, so this should be used with caution. This level of Restore System Defaults does not affect any other system settings, mode settings and does not cause a mode switch. This miscellaneous group contains the rest of the settings that have not been part of the other Restore System Defaults groups. The following table is a complete list of settings associated with this group:

Miscellaneous Setting	Default Value
Verbose SCPI	Off
GPIB Address	18
Auto File Name Number	000
Save Type	State
State Save To	Register 1
Screen Save To	SCREEN000.png
DISP:ENABLE	ON

Miscellaneous Setting	Default Value
Full Screen	Off
SCPI Telnet	ON
SCPI Socket	ON
SICL Server	ON
Display Intensity	100
Display Backlight	ON
Display Theme	TDColor
System Annotation	ON
The SYST:PRES:TYPE	MODE

Confirmation is required to restore the factory default values. The confirmation dialog is:

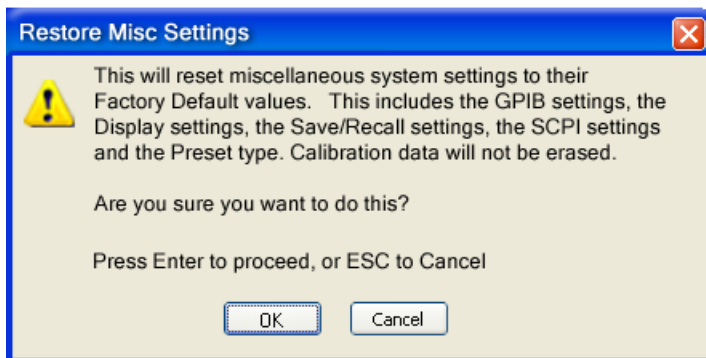

Key Path	System, Restore System Defaults
Example	:SYST:DEF MISC
Instrument S/W Revision	Prior to A.02.00

Restore Mode Defaults (All Modes)

This selection resets all of the modes in the instrument back to their default state just as a Restore Mode Defaults does and it switches the instrument to the power-on mode and causes the default measurement for the power-on mode to be active. This level of Restore System Defaults does not affect any system settings, but it does affect the state of all modes and does cause a mode switch unless the instrument was already in the power-on mode.

Confirmation is required to restore the factory default values. The confirmation dialog is:

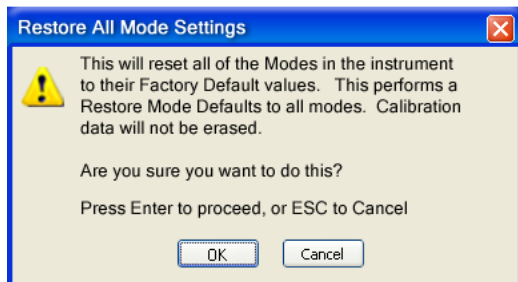

Key Path	System, Restore System Defaults
Example	:SYST:DEF MOD
Dependencies/Couplings	An All Mode will cause the currently running measurement to be aborted, mode switch to the power-on mode and activate the default measurement for the power-on mode. It gets the mode to a consistent state with all of the default couplings set.
Instrument S/W Revision	Prior to A.02.00

All

This is the catastrophic function that does a comprehensive reset of ALL analyzer settings to their factory default values. It resets all of the system setting groups, causes a Restore Mode Defaults for all modes in the instrument, and switches back to the power-on mode. It does not affect the User Preset file or any user saved files.

Confirmation is required to restore the factory default values. The confirmation dialog is:

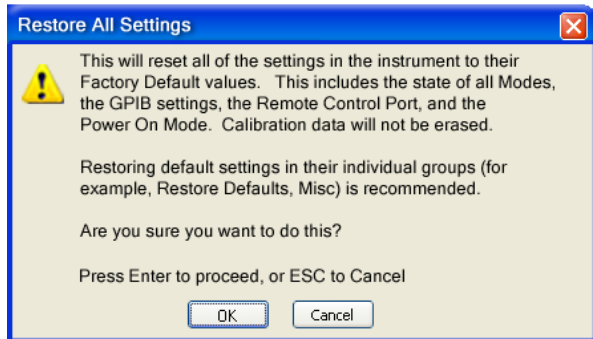

Key Path	System, Restore System Defaults
----------	--

Example	:SYST:DEF ALL
Dependencies/Couplings	An All will cause the currently running measurement to be aborted and get all modes to a consistent state, so it is unnecessary to couple any settings.
Instrument S/W Revision	Prior to A.02.00

Control Panel...

Opens the Windows Control Panel.

Pressing any key will cause the Control Panel to exit.

Key Path	System
Remote Command Notes	No remote command for this key.
Instrument S/W Revision	Prior to A.02.00

Licensing...

Opens the license explorer.

For Help on this key, select Help in the menu bar at the top of the license explorer window.

Key Path	System
Remote Command Notes	No equivalent remote command for this key.
Instrument S/W Revision	Prior to A.02.00

There are five remote commands available for licensing.

Remote Command:	:SYSTem:LKEY <"OptionInfo">, <"LicenseInfo">
Example:	SYST:LKEY "N9073A-1FP", "027253AD27F83CDA5673A9BA5F427FDA5E4F25AEB1 017638211AC9F60D9C639FE539735909C551DE0A91"
Remote Command Notes:	The <"OptionInfo"> contains the feature and the version. You must specify the feature but can omit the version. If you omit the version, the system regards it as the latest one, since the system knows which version is supported for each feature. The <"LicenseInfo"> contains the signature, the expiration date, and serial number for transport if transportable. You must specify the signature, but you can omit the other information. If you omit the expiration date, the system regards it as permanent. If you omit the serial number, the system regards it as non-transportable. As a result, this supports backward compatibility.
Instrument S/W Revision:	Prior to A.02.00
Remote Command:	:SYSTem:LKEY:DELeTe <"OptionInfo">, <"LicenseInfo">

System Functions

System

- Example: SYST:LKEY:DEL
"N9073A-1FP", "027253AD27F83CDA5673A9BA5F427FDA5E4F25AEB1017638211AC9F60D9C639FE539735909C551DE0A91"
- Remote Command Notes: The <"OptionInfo"> contains the feature and the version. You must specify the feature but can omit the version. If you omit the version, the system regards it as the latest one, if more than one version is installed.
- The <"LicenseInfo"> contains the signature, the expiration date, and whether or not be transportable. You must specify the signature, but you can omit the other information. If you omit the expiration date, the system regards it as permanent. If you omit the transportability, the system regards it as non-transportable. As a result, this supports backward compatibility.
- Instrument S/W Revision: Prior to A.02.00
- Remote Command: :SYSTem:LKEY:LIST?
- Remote Command Notes: Return Value:
An <arbitrary block data> of all the installed instrument licenses.
The format of each license is as follows.
<Feature>,<Version>,<Signature>,<Expiration Date>,<Serial Number for Transport>
Return Value Example:
#3136
N9073A-1FP,1.000,B043920A51CA
N9060A-2FP,1.000,4D1D1164BE64
N9020A-508,1.000,389BC042F920
N9073A-1F1,1.000,5D71E9BA814C,13-aug-2005
<arbitrary block data> is:
#NMMM<data>
Where:
N is the number of digits that describes the number of MMM characters. For example if the data was 55 bytes, N would be 2.
MMM would be the ASCII representation of the number of bytes. In the previous example, N would be 55.
<data> ASCII contents of the data
- Instrument S/W Revision: Prior to A.02.00
- Remote Command: :SYSTem:LKEY? <"OptionInfo">
- Example: SYST:LKEY? "N9073A-1FP"

Remote Command Notes:	The <"OptionInfo"> contains the feature and the version. You must specify the feature but can omit the version. If you omit the version, the system regards it as the latest one.
	Return Value: <"LicenseInfo"> if the license is valid, null otherwise. <"LicenseInfo"> contains the signature, the expiration date, and serial number if transportable.
	Return Value Example: "B043920A51CA"
Instrument S/W Revision:	Prior to A.02.00
Remote Command:	:SYSTem:HID?
Remote Command Notes:	Return value is the host ID as a string
Instrument S/W Revision:	Prior to A.02.00

Agilent Upgrade Service

The Agilent Upgrade Service entitles an instrument to software enhancements, if and when they occur, for the duration of the service period. Beginning in September, 2008, all new X-Series instruments will contain 2 years of upgrade service included with the purchase of the instrument. The Agilent Upgrade Service will be option AUS on the N9010A or N9020A. For new instrument purchases the two year entitlement will be from date of manufacture (plus one month for transit and receiving).

The Agilent Upgrade Service is administered via a license which carries the end date of the upgrade entitlement. The license can be viewed in Agilent License Manager, or via the Show System screen.

The Agilent Upgrade Service is for an individual instrument, it cannot be transferred from one instrument to another.

For existing instruments that do not have the Agilent Upgrade Service, or for extending the upgrade service after it has expired, the Agilent Upgrade Service is available as a standalone upgrade product. The two year entitlement will be from the date of redemption of the license.

Agilent Upgrade Service - software update installation

When a software update is being performed on an instrument, the installer will determine if the instrument has a valid Agilent Upgrade Service for the revision of software that is being installed. If the Agilent Upgrade Service is valid, the installation proceeds unencumbered. If the service is not valid, the operator is provided a prompt to contact Agilent for purchasing an Agilent Upgrade Service and the software update is not performed.

Agilent Upgrade Service - software removal

When a software update is being removed from instrument via Add/Remove Programs, the uninstall will check if there is an AUS license with date remaining on the service. If the AUS is expired, the operator will be given a prompt warning that an AUS Renewal may be required to install newer software and how to contact Agilent to obtain the renewal. The operator can choose to proceed with uninstall or terminate at which no software will be removed or altered.

Agilent Upgrade Service - viewing end-of-service date

There are two methods for viewing the end-of-service date of the Agilent Upgrade Service. The first is to use the Show System screen in the instrument application System -> Show -> System. The second is to use the Agilent License Manager. The Agilent License Manager can be invoked from the System menu of the instrument application or by right-mouse clicking on the License Notifier icon in the Windows® task tray.

Agilent Upgrade Service - Listing end-of-service date (Remote Command Only)

The end-of-service date for the Agilent Upgrade Service can be queried via SCPI.

Remote Command:	:SYSTem:AUService:DATE?
Example:	:SYST:AUS:DATE?
Notes:	If there is no Agilent Upgrade Service license installed the date will return "01-sep-2008"
Instrument S/W Revision:	A.02.00

Service

Accesses capabilities performed in the factory or under instructions from repair procedures. This menu key is only visible when the logged-in user is "advanceduser" or "saservice". The first access to the Service Menu after invoking the instrument application will require an authentication Service Code.

Key Path	System
Instrument S/W Revision	Prior to A.02.00

Diagnostics

The Diagnostics key in the System menu gives you access to basic diagnostic capabilities of the instrument.

Key Path	System, More
Instrument S/W Revision	Prior to A.02.00

Show Hardware Statistics

Provides a display of various hardware statistics. The statistics include the following:

Mechanical relay cycles

High and Low temperature extremes

Elapsed time that the instrument has been powered-on (odometer)

The display should appear listing the statistics, product number, serial number, and firmware revision.

Std Header	Product Number: N9020A Serial Number: US46340924 Firmware Revision: A.01.01																		
Mechanical relays	<table> <tbody> <tr> <td>Calibrator Switch Cycles:</td> <td>1800</td> </tr> <tr> <td>AC/DC Switch Cycles:</td> <td>60</td> </tr> <tr> <td>2 dB #1 Mechanical Atten Cycles</td> <td>23489</td> </tr> <tr> <td>2 dB #2 Mechanical Atten Cycles</td> <td>23400</td> </tr> <tr> <td>6 dB Mechanical Atten Cycles</td> <td>500000</td> </tr> <tr> <td>10 dB Mechanical Atten Cycles</td> <td>1000000</td> </tr> <tr> <td>20 dB Mechanical Atten Cycles</td> <td>2500</td> </tr> <tr> <td>30 dB Mechanical Atten Cycles</td> <td>60000</td> </tr> <tr> <td></td> <td>4339</td> </tr> </tbody> </table>	Calibrator Switch Cycles:	1800	AC/DC Switch Cycles:	60	2 dB #1 Mechanical Atten Cycles	23489	2 dB #2 Mechanical Atten Cycles	23400	6 dB Mechanical Atten Cycles	500000	10 dB Mechanical Atten Cycles	1000000	20 dB Mechanical Atten Cycles	2500	30 dB Mechanical Atten Cycles	60000		4339
Calibrator Switch Cycles:	1800																		
AC/DC Switch Cycles:	60																		
2 dB #1 Mechanical Atten Cycles	23489																		
2 dB #2 Mechanical Atten Cycles	23400																		
6 dB Mechanical Atten Cycles	500000																		
10 dB Mechanical Atten Cycles	1000000																		
20 dB Mechanical Atten Cycles	2500																		
30 dB Mechanical Atten Cycles	60000																		
	4339																		
	<table> <tbody> <tr> <td>High operating temperature extreme:</td> <td>+37.2degC</td> </tr> <tr> <td>Low operating temperature extreme</td> <td>+18.1degC</td> </tr> </tbody> </table>	High operating temperature extreme:	+37.2degC	Low operating temperature extreme	+18.1degC														
High operating temperature extreme:	+37.2degC																		
Low operating temperature extreme	+18.1degC																		
Odometer	Elapsed Time (on time) (hours): 1600																		

The data will be updated only when the Show Hardware Statistics menu key is pressed, it will not be updated while the screen is displayed.

The tabular data should be directly printable.

Key Path	System, Diagnostics
Mode	All
Restriction and Notes	The values displayed on the screen are only updated upon entry to the screen and not updated while the screen is being displayed.
Instrument S/W Revision	Prior to A.02.00

Query the Mechanical Relay Cycle Count

Returns the count of mechanical relay cycles.

Remote Command:	:SYSTem:MRELAY:COUNT?
Example:	:SYST:MREL:COUN?
Remote Command Notes:	Query Only
Restriction and Notes:	The return value is a comma separated list of the individual counts for each mechanical relay. The position of the relays in the list is: “<Cal Signal>,<AC/DC>,<2dB #1 Atten>,<2dB #2 Atten>,<6dB Atten>,<10dB Atten>,<20dB Atten>,<30dB Atten>”
Instrument S/W Revision:	Prior to A.02.00

Query the Operating Temperature Extremes

Returns the low operating temperature extreme value. The value survives a power-cycle and is the temperature extreme encountered since the value was reset by the factory or service center.

Mode	All
Remote Command	:SYSTem:TEMPerature:LEXTreme?
Example	:SYST:TEMP:LEXT?
Restriction and Notes	Value is in degrees Celsius at which the lowest operating temperature has been recorded since 1st power-up.
State Saved	No
Instrument S/W Revision	Prior to A.02.00

Returns the high operating temperature extreme value. The value survives a power-cycle and is the temperature extreme encountered since the value was reset by the factory or service center.

Mode	All
Remote Command	:SYSTem:TEMPerature:HEXTreme?
Example	:SYST:TEMP:HEXT?
Restriction and Notes	Value is in degrees Celsius at which the highest operating temperature has been recorded since 1st power-up.
State Saved	No
Instrument S/W Revision	Prior to A.02.00

Query the Elapsed Time since 1st power on

Returns the elapsed on-time in minutes since 1st power-on.

Remote Command: :SYSTem: PON: ETIMe?
 Example: :SYST:PON:ETIM?
 Remote Command Notes: Query Only
 Instrument S/W Revision: Prior to A.02.00

Advanced

Accesses advanced diagnostic capabilities performed in the factory or under instructions from repair procedures. This menu key is only visible when the logged-in user is “saservice”. The first access to the Advanced Diagnostic Menu after invoking the instrument application will require an authentication, which is to enter the Service Code. Subsequent accesses to the Advanced Diagnostic Menu are unimpeded. The Authentication dialog looks like:

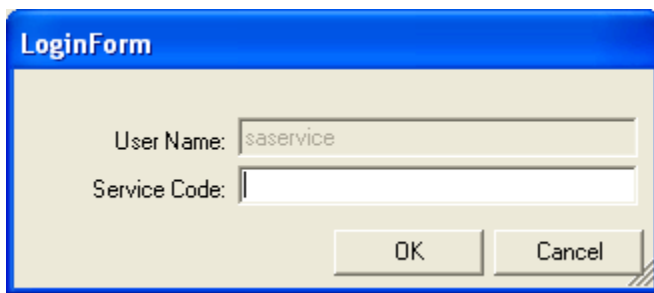

“OK” is the default key thus the Enter key is used to complete the entry. If invalid Service Code is entered authentication is not granted and you are provided the following dialog:



Key Path	System, Diagnostics
Restriction and Notes	Password is required to access this menu.
Instrument S/W Revision	Prior to A.02.00

List installed Options (Remote Command Only)

Lists the installed options that pertain to the instrument (signal analyzer).

Mode	All
Remote Command	:SYSTem:OPTions?
Example	:SYST:OPT?
Restriction and Notes	The return string is a comma separated list of the installed options. For example: "503,P03,PFR" :SYSTem:OPTions? and *OPT? are the same.
State Saved	No
Instrument S/W Revision	Prior to A.02.00

Lock the Front-panel keys (Remote Command Only)

Disables the instrument keyboard to prevent local input when the instrument is controlled remotely. Annunciation showing a "K" for 'Klock' (keyboard lock) alerts the local user that the keyboard is locked. Klock is similar to the GPIB Local Lockout function; namely that no front-panel keys are active with the exception of the Power Standby key. (The instrument is allowed to be turned-off if Klock is ON.) The Klock command is used in remote control situations where Local Lockout cannot be used.

Although primary intent of Klock is to lock-out the front panel, it will lock-out externally connected keyboards through USB. Klock has no effect on externally connected pointing devices (mice).

The front panel 'Local' key (Cancel/Esc) has no effect if Klock is ON.

Mode	All
Remote Command	:SYSTem:KLOCK OFF ON 0 1 :SYSTem:KLOCK?
Example	:SYST:KLOC ON
Remote Command Notes	Keyboard lock remains in effect until turned-off or the instrument is power-cycled
Preset	Initialized to OFF at startup, unaffected by Preset
State Saved	No
Instrument S/W Revision	Prior to A.02.00

List SCPI Commands (Remote Command Only)

Outputs a list of the valid SCPI commands for the currently selected Mode.

Remote Command:	:SYSTem:HELP:HEADers?
Example:	:SYST:HELP:HEAD?
Remote Command Notes:	The output is an IEEE Block format with each command separated with the New-Line character (hex 0x0A)
Instrument S/W Revision:	Prior to A.02.00

SCPI Version Query (Remote Command Only)

Returns the SCPI version number with which the instrument complies. The SCPI industry standard changes regularly. This command indicates the version used when the instrument SCPI commands were defined.

Remote Command:	:SYSTem:VERSion?
Example:	:SYST:VERS?
Instrument S/W Revision:	Prior to A.02.00

Date (Remote Command Only)

The recommended access to the Date, Time, and Time zone of the instrument is through the Windows native control (Control Panel or accessing the Task Bar). You may also access this information remotely, as shown in this command and Time (below).

Sets or queries the date in the instrument.

Mode	All
Remote Command	:SYSTem:DATE "<year>, <month>, <day>" :SYSTem:DATE?
Example	:SYST:DATE "2006,05,26"
Remote Command Notes	<year> is the four digit representation of year. (for example, 2006) <month> is the two digit representation of year. (for example. 01 to 12) <day> is the two digit representation of day. (for example, 01 to 28, 29, 30, or 31) depending on the month and year
Instrument S/W Revision	Prior to A.02.00

Time (Remote Command Only)

Sets or queries the time in the instrument.

Mode	All
Remote Command	:SYSTem:TIME "<hour>, <minute>, <second>" :SYSTem:TIME?
Example	:SYST:TIME "13,05,26"
Remote Command Notes	<hour> is the two digit representation of the hour in 24 hour format <minute> is the two digit representation of minute <second> is the two digit representation of second
Instrument S/W Revision	Prior to A.02.00

User Preset

The User Preset key opens up a menu that gives you three choices – execute the **User Preset** by pressing the **User Preset** key, User Preset all of the modes in the analyzer by pressing the **User Preset All Modes** key, and save the current state for the current mode by pressing the **Save User Preset** key.

Key Path	Front-panel key
Instrument S/W Revision	Prior to A.02.00

User Preset

User Preset behaves similarly to **Recall State** in that it recalls a hidden Save State file. However, since each Mode has its own **User Preset** file, **User Preset** will never cause a mode switch, whereas recalling a Save State file may cause a mode switch, if the Save State file was saved while in a different mode.

The User Preset file is a Save State file. **User Preset** sets the state of the currently active mode back to the state that was previously saved for this mode using the **Save User Preset** menu key or the SCPI command, `SYST:PRESet:USER:SAV`. So for any given Mode, the only way to perform a User Preset is from that Mode, not from any other Mode. The user has no control over the user preset filename and has no direct access to the user preset file.

User Preset recalls a mode's state which includes all of the variables affected by doing a Mode Preset. It not only recalls Mode Preset settings, but it also recalls all of the mode persistent settings. User Preset also recalls all of the Input/Output system settings that existed at the time **Save User Preset** was executed.

If a **Save User Preset** has not been done at any time, **User Preset** recalls the default user preset file for the currently active mode. The default user preset files are created if, at power-on, a mode detects there is no user preset file, so there will never be a scenario when there is no user preset file to restore. For each mode, the default user preset state is the same state that would be saved if a **Save User Preset** is performed in each mode right after doing a Restore Mode Default and after a Restore Input/Output Defaults.

User Preset does the following:

- Aborts the currently running measurement.
- Sets the mode state to the values defined by **Save User Preset**.
- Makes the saved measurement for the currently running mode the active measurement.
- Brings up the saved menu for the power-on mode.
- Clears the input and output buffers.
- Sets the Status Byte to 0.

Key Path	User Preset
Remote Command	:SYSTem:PRESet:USER

System Functions

User Preset

Example	: SYST: PRES: USER: SAVE : SYST: PRES: USER
Remote Command Notes	: SYST: PRES: USER: SAVE is used to save the current state as the user preset state.
Restriction and Notes	Clears all pending OPC bits. The Status Byte is set to 0.
Dependencies/Couplings	A user preset will cause the currently running measurement to be aborted and cause the saved measurement to be active. Recalling a User Preset file has the same issues that recalling a Save State file has. Some settings may need to be limited and therefore re-coupled, since the capabilities of the mode may have changes when the User Preset file was last saved.
Instrument S/W Revision	Prior to A.02.00

User Preset All Modes

User Preset All Modes behaves similarly to Power On User Preset, since it recalls all of the User Preset files for each mode, switches to the power-on mode and activates the saved measurement from the power-on mode User Preset file.

NOTE When the instrument is secured, all of the user preset files are converted back to their default user preset files.

User Preset does the following:

- Aborts the currently running measurement.
- Switches the Mode to the power-on mode.
- Restores the User Preset files for each mode.
- Makes the saved measurement for the power-on mode the active measurement.
- Brings up the saved menu for the power-on mode.
- Clears the input and output buffers.
- Sets the Status Byte to 0.

Key Path	User Preset
Remote Command	: SYSTem: PRESet: USER: ALL
Example	: SYST: PRES: USER: SAVE : SYST: PRES: USER: ALL
Remote Command Notes	: SYST: PRES: USER: SAVE is used to save the current state as the user preset state.
Restriction and Notes	Clears all pending OPC bits. The Status Byte is set to 0.

Dependencies/Couplings	A user preset will cause the currently running measurement to be aborted, cause a mode switch to the power-on mode, and cause the saved measurement to be active in the power-on mode. Recalling a User Preset file has the same issues that recalling a Save State file has. Some settings may need to be limited and therefore re-coupled, since the capabilities of the mode may have changes when the User Preset file was last saved.
Instrument S/W Revision	Prior to A.02.00

Save User Preset

Save User Preset saves the currently active mode and its state. The way you recall this User Preset file is by pressing the User Preset menu key or sending the SYST:PRES:USER remote command. This same state is also saved by the Save State function.

Key Path	User Preset
Remote Command	:SYSTem:PRESet:USER:SAVE
Example	:SYST:PRES:USER:SAVE
Restriction and Notes	:SYST:PRES:SAVE creates the same file as if you requested a *SAV or a MMEM:STOR:STAT, except User Preset Save does not allow you to specify the filename or the location of the file.
Instrument S/W Revision	Prior to A.02.00

System Functions
User Preset

The monitor spectrum measurement is used as a quick, convenient means of looking at the entire spectrum. While the look and feel are similar to the Spectrum Analyzer mode, the functionality is greatly reduced for easy operation. The main purpose of the measurement is to show the spectrum. The default span should cover an appropriate frequency range of the application. For measurement results and views, see [“View/Display” on page 299](#).

This topic contains the following sections:

[“Measurement Commands for Monitor Spectrum” on page 257](#)

[“Remote Command Results for Monitor Spectrum Measurement” on page 257](#)

Measurement Commands for Monitor Spectrum

The following commands can be used to retrieve the measurement results:

```
:CONFigure:MONitor
```

```
:CONFigure:MONitor:NDEFault
```

```
:INITiate:MONitor
```

```
:FETCh:MONitor [n] ?
```

```
:READ:MONitor [n] ?
```

```
:MEASure:MONitor [n] ?
```

For more measurement related commands, see the SENSE subsystem, and the section [“Remote Measurement Functions” on page 535](#).

Remote Command Results for Monitor Spectrum Measurement

n	Results Returned
n=1 (or not specified)	Returns trace1 data with comma separated floating numbers
n=2	Returns trace2 data with comma separated floating numbers
n=3	Returns trace3 data with comma separated floating numbers

Key Path	Meas
Instrument S/W Revision	Prior to A.02.00

AMPTD Y Scale

Accesses a menu of functions that enable you to set the vertical scale parameters. These functions control how data on the vertical (Y) axis is displayed and control instrument settings that affect the vertical axis.

Key Path	Front-panel key
Instrument S/W Revision	Prior to A.02.00

Ref Value

Sets the absolute power reference value. However, since the Auto Scaling is defaulted to On, this value is automatically determined by the measurement result. When you set a value manually, Auto Scaling automatically changes to Off.

Key Path	AMPTD Y Scale
Mode	All except SA and BASIC
Remote Command	:DISPlay:MONitor:VIEW[1]:WINDow[1]:TRACe:Y[:SCALE]:RLEVel <real> :DISPlay:MONitor:VIEW[1]:WINDow[1]:TRACe:Y[:SCALE]:RLEVel?
Example	DISP:MON:VIEW:WIND:TRAC:Y:RLEV 2.0 DISP:MON:VIEW:WIND:TRAC:Y:RLEV?
Dependencies/Couplings	When the Auto Scaling is On, this value is automatically determined by the measurement result. When you set a value manually, Auto Scaling automatically changes to Off.
Preset	10.00 dBm
State Saved	Saved in instrument state.
Min	-250.00 dBm
Max	250.00 dBm
Instrument S/W Revision	Prior to A.02.00

Attenuation

Accesses a menu of functions that enable you to change the attenuation settings.

See AMPTD Y Scale, “Attenuation” on page 443 in the “Common Measurement Functions” section for more information.

Key Path	AMPTD Y Scale
Instrument S/W Revision	Prior to A.02.00

Scale/Div

Sets the logarithmic units per vertical graticule division on the display. However, since the Auto Scaling is defaulted to On, this value is automatically determined by the measurement result. When you set a value manually, Auto Scaling automatically changes to Off.

Key Path	AMPTD Y Scale
Mode	All except SA and BASIC
Remote Command	:DISPlay:MONitor:VIEW[1]:WINDow[1]:TRACe:Y[:SCALe]: PDIVision <rel_ampl> :DISPlay:MONitor:VIEW[1]:WINDow[1]:TRACe:Y[:SCALe]: PDIVision?
Example	DISP:MON:VIEW:WIND:TRAC:Y:PDIV 5.0 dB DISP:MON:VIEW:WIND:TRAC:Y:PDIV?
Dependencies/Couplings	When the Auto Scaling is On, this value is automatically determined by the measurement result. When you set a value manually, Auto Scaling automatically changes to Off.
Preset	10.00 dB
State Saved	Saved in instrument state.
Min	0.10 dB
Max	20.00 dB
Instrument S/W Revision	Prior to A.02.00

Presel Center

See AMPTD Y Scale, “Presel Center” on page 455 in the “Common Measurement Functions” section for more information.

Presel Adjust

See AMPTD Y Scale, “Preselector Adjust” on page 456 in the “Common Measurement Functions” section for more information.

Internal Preamp

Accesses a menu of functions that enable you to control the internal preamplifiers.

See AMPTD Y Scale, “Internal Preamp” on page 458 in the “Common Measurement Functions” section for more information.

Key Path	AMPTD Y Scale
Instrument S/W Revision	Prior to A.02.00

Ref Position

Positions the reference level at the top, center or bottom of the Y Scale display. Changing the reference position does not change the reference level value.

Key Path	AMPTD Y Scale
Mode	All except SA and BASIC
Remote Command	:DISPlay:MONitor:VIEW[1]:WINDow[1]:TRACe:Y[:SCALE]:RPOSition TOP CENTer BOTTom :DISPlay:MONitor:VIEW[1]:WINDow[1]:TRACe:Y[:SCALE]:RPOSition?
Example	DISP:MON:VIEW:WIND:TRAC:Y:RPOS CENT DISP:MON:VIEW:WIND:TRAC:Y:RPOS?
Preset	TOP
State Saved	Saved in instrument state.
Range	Top Ctr Bot
Instrument S/W Revision	Prior to A.02.00

Auto Scaling

Toggles the Auto Scaling function between On and Off.

Key Path	AMPTD Y Scale
Mode	All except SA and BASIC

Remote Command	<code>:DISPlay:MONitor:VIEW[1]:WINDow[1]:TRACe:Y[:SCALe]:COUPlE 0 1 OFF ON</code> <code>:DISPlay:MONitor:VIEW[1]:WINDow[1]:TRACe:Y[:SCALe]:COUPlE?</code>
Example	<code>DISP:MON:VIEW:WIND:TRAC:Y:COUP ON</code> <code>DISP:MON:VIEW:WIND:TRAC:Y:COUP?</code>
Dependencies/Couplings	When Auto Scaling is On, and the Restart front-panel key is pressed, this function automatically determines the scale per division and reference values based on the measurement results. When you set a value to either Scale/Div or Ref Value manually, Auto Scaling automatically changes to Off.
Preset	ON
State Saved	Saved in instrument state.
Range	On Off
Instrument S/W Revision	Prior to A.02.00

Auto Couple

See “**AUTO COUPLE**” on page 461 in the section "Common Measurement Functions" for more information.

BW

Accesses a menu that enables you to specify the resolution bandwidth functions that control the bandwidth and filter selection.

Key Path	Front-panel key
Instrument S/W Revision	Prior to A.02.00

Res BW

Sets the resolution bandwidth for the current measurement. If an unavailable bandwidth is entered with the numeric keypad, the closest available bandwidth is selected.

Key Path	BW
Mode	All except SA and BASIC
Remote Command	[:SENSE]:MONitor:BANDwidth[:RESolution] <freq> [:SENSE]:MONitor:BANDwidth[:RESolution]? [:SENSE]:MONitor:BANDwidth[:RESolution]:AUTO OFF ON 0 1 [:SENSE]:MONitor:BANDwidth[:RESolution]:AUTO?
Example	MON:BAND 2.4 MHz MON:BAND? MON:BAND:AUTO ON MON:BAND:AUTO?
Preset	WCDMA: Automatically calculated WIMAX OFDMA: 100kHz C2K: Automatically calculated PN: Automatically calculated GSM/EDGE: Automatically calculated TD-SCDMA: Automatically calculated 1xEVDO: 30kHz DVB-T/H: 3.9kHz DTMB: 3.9kHz
State Saved	Saved in instrument state.
Min	1.0 Hz
Max	8.0 MHz
Instrument S/W Revision	Prior to A.02.00

Video BW

Changes the analyzer post-detection filter.

Key Path	BW
Mode	All except SA and BASIC
Remote Command	[:SENSe]:MONitor:BANDwidth:VIDeo <bandwidth> [:SENSe]:MONitor:BANDwidth:VIDeo? [:SENSe]:MONitor:BANDwidth:VIDeo:AUTO ON OFF 1 0 [:SENSe]:MONitor:BANDwidth:VIDeo:AUTO?
Example	MON:BAND:VID 10 MHz MON:BAND:VID? MON:BAND:VID:AUTO OFF MON:BAND:VID:AUTO?
Preset	WCDMA: Automatically calculated WIMAX OFDMA: 1MHz C2K: Automatically calculated PN: Automatically calculated GSM/EDGE: Automatically calculated TD-SCDMA: Automatically calculated 1xEVDO: 300kHz DVB-T/H: 39kHz DTMB: 39kHz
State Saved	Saved in instrument state.
Min	1 Hz
Max	50 MHz
Instrument S/W Revision	Prior to A.02.00

VBW:3dB RBW

Selects the ratio between the video bandwidth and the equivalent 3 dB resolution bandwidth to be used for setting the VBW when VBW is in Auto.

Key Path	BW
Mode	All except SA and BASIC

Remote Command	[:SENSE]:MONitor:BANDwidth:VIDeo:RATio <real> [:SENSE]:MONitor:BANDwidth:VIDeo:RATio? [:SENSE]:MONitor:BANDwidth:VIDeo:RATio:AUTO OFF ON 0 1 [:SENSE]:MONitor:BANDwidth:VIDeo:RATio:AUTO?
Example	MON:BAND:VID:RAT 2 MON:BAND:VID:RAT? MON:BAND:VID:RAT:AUTO 0 MON:BAND:VID:RAT:AUTO?
Preset	1 ON
State Saved	Saved in instrument state.
Min	0.00001
Max	3000000
Instrument S/W Revision	Prior to A.02.00

Span:3dB RBW

Selects the ratio between span and resolution bandwidth.

The default setting is Auto with a Span:3 dB RBW ratio of 106:1. You can manually change this ratio by pressing the key, entering a new value, and pressing Enter.

Key Path	BW
Mode	All except SA and BASIC
Remote Command	[:SENSE]:MONitor:FREQuency:SPAN:BANDwidth[:RESolution]: RATio <integer> [:SENSE]:MONitor:FREQuency:SPAN:BANDwidth[:RESolution]: RATio? [:SENSE]:MONitor:FREQuency:SPAN:BANDwidth[:RESolution]: RATio:AUTO OFF ON 0 1 [:SENSE]:MONitor:FREQuency:SPAN:BANDwidth[:RESolution]: RATio:AUTO?
Example	MON:FREQ:SPAN:BAND:RAT 200 MON:FREQ:SPAN:BAND:RAT? MON:FREQ:SPAN:BAND:RAT:AUTO ON MON:FREQ:SPAN:BAND:RAT:AUTO?
Preset	106 ON

Monitor Spectrum Measurement BW

State Saved	Saved in instrument state.
Min	2
Max	10000
Instrument S/W Revision	Prior to A.02.00

Cont

See “[Cont \(Continuous Measurement/Sweep\)](#)” on page 465 in the section "Common Measurement Functions" for more information.

FREQ Channel

See “[FREQ Channel](#)” on page 467 in the section "Common Measurement Functions" for more information.

Input/Output

See “[Input/Output](#)” on page 471 in the section "Common Measurement Functions" for more information.

Marker

Accesses a menu that enables you to select, set up and control the markers for the current measurement.

See the "Marker Functions" section for more information

Key Path	Front-panel key
Instrument S/W Revision	Prior to A.02.00

Select Marker

Displays 12 markers available for selection.

Key Path	Marker
Instrument S/W Revision	Prior to A.02.00

Marker Type

Sets the marker control mode to **Normal**, **Delta** or **Off**. If the selected marker is Off, pressing Marker sets it to Normal and places a single marker at the center of the display. At the same time, **Marker X Axis Value** appears on the Active Function area.

Key Path	Marker
Mode	All except SA and BASIC
Remote Command	:CALCulate:MONitor:MARKer [1] 2 3 4 5 6 7 8 9 10 11 12 : MODE POSition DELTA OFF :CALCulate:MONitor:MARKer [1] 2 3 4 5 6 7 8 9 10 11 12 : MODE?
Example	CALC:MON:MARK:MODE POS CALC:MON:MARK:MODE?
Notes	If the selected marker is Off, pressing Marker sets it to Normal and places it at the center of the screen on the trace determined by the Marker Trace rules. At the same time, Marker X Axis Value appears on the Active Function area. Default Active Function: the active function for the selected marker's current control mode. If the current control mode is Off, there is no active function and the active function is turned off. Active Function Display: the marker X axis value entered in the active function area displays the marker value to its full entered precision.
Preset	OFF
State Saved	Saved in instrument state.

Range	Normal Delta Off
Instrument S/W Revision	Prior to A.02.00

Marker X Axis Value (Remote Command only)

Sets the marker X Axis value in the current marker X Axis Scale unit. It has no effect if the control mode is **Off**, but is the SCPI equivalent of entering an X value if the control mode is **Normal** or **Delta**.

Mode	All except SA and BASIC
Remote Command	:CALCulate:MONitor:MARKer [1] 2 3 4 5 6 7 8 9 10 11 12 : X <freq> :CALCulate:MONitor:MARKer [1] 2 3 4 5 6 7 8 9 10 11 12 : X?
Example	CALC:MON:MARK3:X 0 CALC:MON:MARK3:X?
Notes	If no suffix is sent, uses the fundamental units for the current marker X Axis Scale. If a suffix is sent that does not match the current marker X Axis Scale unit, an error “Invalid suffix” is generated. The query returns the marker’s absolute X Axis value if the control mode is Normal , or the offset from the marker’s reference marker if the control mode is Delta . The query is returned in the fundamental units for the current marker X Axis scale: Hz for Frequency and Inverse Time , seconds for Period and Time . If the marker is Off the response is not a number.
Preset	After a preset, all markers are turned OFF, so Marker X Axis Value query returns a not a number (NAN).
State Saved	No
Min	-9.9E+37
Max	9.9E+37
Instrument S/W Revision	Prior to A.02.00

Marker X Axis Position (Remote Command only)

Sets the marker X position in trace points. It has no effect if the control mode is **Off**, but is the SCPI equivalent of entering a value if the control mode is **Normal** or **Delta** – except in trace points rather than X Axis Scale units. The entered value is immediately translated into the current X Axis Scale units for setting the value of the marker.

Mode	All except SA and BASIC
Remote Command	:CALCulate:MONitor:MARKer [1] 2 3 4 5 6 7 8 9 10 11 12 : X:POSition <real> :CALCulate:MONitor:MARKer [1] 2 3 4 5 6 7 8 9 10 11 12 : X:POSition?

Monitor Spectrum Measurement Marker

Example	CALC:MON:MARK:X:POS 0 CALC:MON:MARK:X:POS?
Notes	The query returns the marker's absolute X Axis value in trace points if the control mode is Normal , or the offset from the marker's reference marker in trace points if the control mode is Delta . The value is returned as a real number, not an integer, corresponding to the translation from X Axis Scale units to trace points. If the marker is Off the response is not a number.
Preset	After a preset, all markers are turned OFF, so Marker X Axis Value query returns a not a number (NAN).
State Saved	No
Min	-9.9E+37
Max	9.9E+37
Instrument S/W Revision	Prior to A.02.00

Marker Y Axis Value (Remote Command only)

Returns the marker Y Axis value in the current marker.

Mode	All except SA and BASIC
Remote Command	:CALCulate:MONitor:MARKer [1] 2 3 4 5 6 7 8 9 10 11 12 : Y?
Example	CALC:MON:MARK11:Y?
Preset	Result dependant on markers setup and signal source
Instrument S/W Revision	Prior to A.02.00

Properties

Accesses a menu that enables you to select the active marker, the reference marker and the trace for the current measurement.

Key Path	Marker
Instrument S/W Revision	Prior to A.02.00

Select Marker

Displays 12 markers available for selection.

Key Path	Marker
Instrument S/W Revision	Prior to A.02.00

Relative To

Selects the desired marker. The selected marker is relative to its reference marker

Key Path	Marker, Properties
Mode	All except SA and BASIC
Remote Command	:CALCulate:MONitor:MARKer [1] 2 3 4 5 6 7 8 9 10 11 12 : REFerence <integer> :CALCulate:MONitor:MARKer [1] 2 3 4 5 6 7 8 9 10 11 12 : REFerence?
Example	CALC:MON:MARK:REF 1 CALC:MON:MARK:REF?
Notes	A marker cannot be relative to itself so that choice is grayed out, and if sent from SCPI generates error -221: "Settings conflict; marker cannot be relative to itself." When queried a single value is returned (the specified marker number's relative marker).
Preset	2 3 4 5 6 7 8 9 10 11 12 1
State Saved	Saved in instrument state.
Min	1
Max	12
Instrument S/W Revision	Prior to A.02.00

Marker Trace

Assigns the specified marker to the designated trace.

Key Path	Marker, Properties
Mode	All except SA and BASIC
Remote Command	:CALCulate:MONitor:MARKer [1] 2 3 4 5 6 7 8 9 10 11 12 : TRACe <integer> :CALCulate:MONitor:MARKer [1] 2 3 4 5 6 7 8 9 10 11 12 : TRACe?
Example	CALC:MON:MARK:TRAC 1 CALC:MON:MARK:TRAC?
Preset	1
State Saved	Saved in instrument state.
Min	1
Max	3

Instrument S/W Revision Prior to A.02.00

Couple Markers

When this function is true, moving any marker causes an equal X Axis movement of every other marker which is not **Off**. By “equal X Axis movement” we mean that we preserve the difference between each marker’s X Axis value (in the fundamental x-axis units of the trace that marker is on) and the X Axis value of the marker being moved (in the same fundamental x-axis units).

Key Path	Marker
Mode	All except SA and BASIC
Remote Command	:CALCulate:MONitor:MARKer:COUPle[:STATe] ON OFF 1 0 :CALCulate:MONitor:MARKer:COUPle[:STATe]?
Example	CALC:MON:MARK:COUP ON CALC:MON:MARK:COUP?
Preset	OFF
State Saved	Saved in instrument state.
Range	On Off
Instrument S/W Revision	Prior to A.02.00

All Markers Off

Turns off all markers on the current measurement.

Key Path	Marker
Mode	All except SA and BASIC
Remote Command	:CALCulate:MONitor:MARKer:AOFF
Example	CALC:MON:MARK:AOFF
Instrument S/W Revision	Prior to A.02.00

Marker Function

Accesses special marker functions such as marker noise, and power in a specified bandwidth or time interval.

Key Path	Front-panel key
Instrument S/W Revision	Prior to A.02.00

Select Marker

Selects one of the 12 available markers.

Key Path	Marker Function
Instrument S/W Revision	Prior to A.02.00

Marker Function Type

Sets the marker control function type to, Marker Noise, Band/Interval Power, Band Interval Density, or Marker Function Off.

Key Path	Marker Function
Mode	All except SA and BASIC
Remote Command	:CALCulate:MONitor:MARKer[1] 2 3 4 5 6 7 8 9 10 11 12: FUNction NOISe BPOwer BDENsity OFF :CALCulate:MONitor:MARKer[1] 2 3 4 5 6 7 8 9 10 11 12: FUNction?
Example	CALC:MON:MARK:FUNC NOIS CALC:MON:MARK:FUNC?
Preset	OFF
State Saved	Saved in instrument state.
Range	Marker Noise Band/Interval Power Band Interval Density Marker Function Off
Instrument S/W Revision	Prior to A.02.00

Band Adjust

Accesses a menu that enables you to set the frequency span width and the left and right edge, or time values, for the band or interval of the selected marker.

Key Path	Marker Function
Instrument S/W Revision	Prior to A.02.00

Band/Interval Span for Frequency Domain

Sets the width of the frequency span for the selected marker.

Key Path	Marker Function
Mode	All except SA and BASIC
Remote Command	:CALCulate:MONitor:MARKer [1] 2 3 4 5 6 7 8 9 10 11 12 : FUNction:BAND:SPAN <freq> :CALCulate:MONitor:MARKer [1] 2 3 4 5 6 7 8 9 10 11 12 : FUNction:BAND:SPAN?
Example	CALC:MON:MARK12:FUNC:BAND:SPAN 20 MHz CALC:MON:MARK12:FUNC:BAND:SPAN?
Dependencies/Couplings	Changing the Band/Interval Span necessarily changes the Band/Interval Left and Band/Interval Right values.
Preset	Depends on X axis range of selected Trace.
State Saved	Saved in instrument state.
Min	-9.9E+37
Max	9.9E+37
Instrument S/W Revision	Prior to A.02.00

Band/Interval Left for Frequency Domain

Sets the left edge frequency or time value for the band of the selected marker.

Key Path	Marker Function
Mode	All except SA and BASIC
Remote Command	:CALCulate:MONitor:MARKer [1] 2 3 4 5 6 7 8 9 10 11 12 : FUNction:BAND:LEFT <freq> :CALCulate:MONitor:MARKer [1] 2 3 4 5 6 7 8 9 10 11 12 : FUNction:BAND:LEFT?
Example	CALC:MON:MARK12:FUNC:BAND:LEFT 20 GHz CALC:MON:MARK12:FUNC:BAND:LEFT?

Dependencies/Couplings	Changing the Band/Interval Left necessarily changes the Band/Interval Span and Band/Interval Right values.
Preset	Depends on X axis range of selected Trace.
State Saved	Saved in instrument state.
Min	-9.9E+37
Max	9.9E+37
Instrument S/W Revision	Prior to A.02.00

Band/Interval Right for Frequency Domain

Sets the right edge frequency or time value for the band of the selected marker.

Key Path	Marker Function
Mode	All except SA and BASIC
Remote Command	:CALCulate:MONitor:MARKer[1] 2 3 4 5 6 7 8 9 10 11 12:FUNCTION:BAND:RIGHT <freq> :CALCulate:MONitor:MARKer[1] 2 3 4 5 6 7 8 9 10 11 12:FUNCTION:BAND:RIGHT?
Example	CALC:MON:MARK12:FUNC:BAND:RIGH 20 GHz CALC:MON:MARK12:FUNC:BAND:RIGH?
Dependencies/Couplings	Changing the Band/Interval Right necessarily changes the Band/Interval Left and Band/Interval Span values
Preset	Depends on X axis range of selected Trace.
State Saved	Saved in instrument state.
Min	-9.9E+37
Max	9.9E+37
Instrument S/W Revision	Prior to A.02.00

Marker To

There is no Marker To functionality supported in Monitor Spectrum. The front-panel key displays a blank menu key when pressed.

Key Path	Front-panel key
Instrument S/W Revision	Prior to A.02.00

Meas

See “[Meas](#)” on page 535 in the section "Common Measurement Functions" for more information.

Meas Setup

Displays the setup menu for the current measurement. The measurement setup parameters include the number of measurement averages used to calculate the measurement result and the averaging mode. The setup menu also includes the option to reset the measurement settings to their factory defaults.

Key Path	Front-panel key
Instrument S/W Revision	Prior to A.02.00

Avg/Hold Num

Specifies the number of measurement averages used when calculating the measurement result. The average is displayed at the end of each sweep.

After the specified number of average counts, the averaging mode (terminal control) setting determines the averaging action.

Key Path	Meas Setup
Mode	All except SA and BASIC
Remote Command	[:SENSE]:MONitor:AVERage:COUNT <integer> [:SENSe]:MONitor:AVERage:COUNT? [:SENSE]:MONitor:AVERage[:STATe] OFF ON 0 1 [:SENSe]:MONitor:AVERage[:STATe]?
Example	MON:AVER:COUN 25 MON:AVER:COUN? MON:AVER ON MON:AVER?
Preset	10 OFF
State Saved	Saved in instrument state.
Min	1
Max	1000
Instrument S/W Revision	Prior to A.02.00

Avg Mode

Toggles the average mode between exponential (Exp) and Repeat.

Exp- continues measurement averaging, using the specified number of averages to compute each averaged value. The average is displayed at the end of each sweep.

Repeat- causes the measurement to reset the average counter each time the specified number of averages is reached.

Key Path	Meas Setup
Mode	All except SA and BASIC
Remote Command	[:SENSe] :MONitor:AVERage:TCONtrol EXPonential REPeat [:SENSe] :MONitor:AVERage:TCONtrol?
Example	MON:AVER:TCON EXP MON:AVER:TCON?
Preset	EXPonential
State Saved	Saved in instrument state.
Range	ExpRepeat
Instrument S/W Revision	Prior to A.02.00

Meas Preset

Restores all the measurement parameters to their default values.

Key Path	Meas Setup
Mode	All except SA and BASIC
Remote Command	:CONFigure:MONitor
Example	CONF:MON
Instrument S/W Revision	Prior to A.02.00

Mode

See “[Mode](#)” on page 551 in the section "Common Measurement Functions" for more information.

Mode Setup

See “[Mode Setup](#)” on page 565 in the section "Common Measurement Functions" for more information.

Peak Search

There is no Peak Search functionality supported in Monitor Spectrum. The front-panel key displays a blank menu key when pressed.

Key Path	Front-panel key
Instrument S/W Revision	Prior to A.02.00

Recall

See [“Recall” on page 569](#) in the section "Common Measurement Functions" for more information.

Restart

See “[Restart](#)” on page 591 in the section "Common Measurement Functions" for more information.

Save

See [“Save” on page 593](#) in the section "Common Measurement Functions" for more information.

Single

See “[Single \(Single Measurement/Sweep\)](#)” on page 619 in the section "Common Measurement Functions" for more information.

Source

See “[Source](#)” on page 621 in the section "Common Measurement Functions" for more information.

Span X Scale

Accesses a menu of functions that enable you to set the horizontal scale parameters.

Key Path	Front-panel key
Instrument S/W Revision	Prior to A.02.00

Span

Changes the frequency range symmetrically about the center frequency.

Key Path	Span X Scale
Mode	All except SA, BASIC
Remote Command	[:SENSE] :MONitor:FREQuency:SPAN <freq> [:SENSE] :MONitor:FREQuency:SPAN?
Example	MON:FREQ:SPAN 1 MHz MON:FREQ:SPAN?
Dependencies/Couplings	Changing the span causes the resolution bandwidth to change automatically, and affects data acquisition time.
Preset	WCDMA: 10.0 MHz WIMAX OFDMA: 50.0 MHz C2K: 2.5MHz PN: 1.0 MHz GSM/EDGE: 1.0 MHz TD-SCDMA: 3.2 MHz 1xEVDO: 2.0MHz DVB-T/H: 10.0MHz DTMB: 10.0MHz
State Saved	Saved in instrument state.
Min	10 Hz
Max	Hardware Dependent: Option 503 = 3.7 GHz Option 507 = 7.1GHz Option 508 = 8.5 GHz Option 513 = 13.8 GHz Option 526 = 27.0 GHz

Instrument S/W Revision Prior to A.02.00

Full Span

Changes the Span to show the full frequency range of the analyzer.

Key Path	Span X Scale
Mode	All except SA and BASIC
Remote Command	[:SENSE] :MONitor:FREQuency:SPAN:FULL
Example	MON:FREQ:SPAN:FULL
Dependencies/Couplings	Sets the span to the full frequency range, and adjusts the center frequency accordingly.
Instrument S/W Revision	Prior to A.02.00

Last Span

Changes the measurement span to the span setting of the previous measurement. If there is no existing previous span value, then the span remains unchanged.

Key Path	Span X Scale
Mode	All except SA and BASIC
Remote Command	[:SENSE] :MONitor:FREQuency:SPAN:PREVIOUS
Example	MON:FREQ:SPAN:PREV
Dependencies/Couplings	Selecting last span changes the measurement span value.
Instrument S/W Revision	Prior to A.02.00

Sweep/Control

Access a menu of functions that enable you to set up and control the sweep time for the current measurement

Key Path	Front-panel key
Instrument S/W Revision	Prior to A.02.00

Sweep Time

Selects the length of time in which the spectrum analyzer sweeps the displayed frequency span. Additional overhead time is required by the analyzer. It impacts the sweep rate, but is not calculated as part of the sweep time. Reducing the sweep time increases the rate of sweeps.

Key Path	Sweep/Control
Mode	All except SA and BASIC
Remote Command	[:SENSe]:MONitor:SWEep:TIME <time> [:SENSe]:MONitor:SWEep:TIME? [:SENSe]:MONitor:SWEep:TIME:AUTO OFF ON 0 1 [:SENSe]:MONitor:SWEep:TIME:AUTO?
Example	MON:SWE:TIME 100 ms MON:SWE:TIME? MON:SWE:TIME:AUTO ON MON:SWE:TIME:AUTO?
Dependencies/Couplings	When the user manually changes the Sweep Time, this set automatically goes to 'Man'.
Preset	Automatically Calculated
State Saved	Saved in instrument state.
MIN/MAX/DEF Support	Yes
Min	1 ms
Max	4000 s
Instrument S/W Revision	Prior to A.02.00

Pause

Pauses a measurement after the current data acquisition is complete. When Paused, the label on the key changes to Resume. Pressing Resume continues the measurement at the point where it had been paused.

See “Pause/Resume” on page 626 under Sweep/Control in the "Common Measurement Functions" section for more information.

Key Path	Sweep/Control
Instrument S/W Revision	Prior to A.02.00

Gate

Accesses a menu that enables you to control the gating function .

The Gate functionality is used to view signals best viewed by qualifying them with other events.

See “Gate ” on page 626 in “common Measurement Functions” for more details.

Key Path	Sweep/Control
Instrument S/W Revision	Prior to A.02.00

Points

Sets the number of points per sweep. The resolution of setting the sweep time depends on the number of points selected. If Preset is selected, the number of points per sweep defaults to 1001. The current value of points is displayed parenthetically, next to the sweep time in the lower right corner of the display.

Key Path	Sweep/Control
Mode	All except SA and BASIC
Remote Command	[:SENSE] :MONitor:SWEep:POINts <integer> [:SENSe] :MONitor:SWEep:POINts?
Example	:MON:SWE:POIN 1000 :MON:SWE:POIN?
Dependencies/Couplings	Whenever the number of sweep points changes, the sweep time is re-quantized.
Preset	1001
State Saved	Saved in instrument state.
Range	1 to 20001
Instrument S/W Revision	Prior to A.02.00

Trace/Detector

Accesses a menu that enables you to control the display, storage, detection and manipulation of trace data. Each trace is comprised of a series of data points in which X and Y axis information is stored. The analyzer updates the information for the active trace with each sweep of the current measurement.

Key Path	Front-panel key
Instrument S/W Revision	Prior to A.02.00

Select Trace

Allows you to select which trace you want to use for the current measurement. You can select one of three traces. Monitor Spectrum supports 3 traces, numbered 1 through 3.

Key Path	Trace/Detector
Mode	All except SA and BASIC
Preset	Trace 1
State Saved	The number of the selected trace is saved in Instrument State
Instrument S/W Revision	Prior to A.02.00

Trace Type

Allows you to select the type of trace you want to you use for the current measurement. You can assign a trace type to one of the three available traces.

The first page of this menu contains a 1-of-N selection of the trace type (**Clear Write, Average, Max Hold, Min Hold**) for the selected trace.

Key Path	Trace/Detector
Mode	All except SA and BASIC
Remote Command	:TRACe [1] 2 3 :MONitor:TYPE WRITe AVERAge MAXHold MINHold :TRACe [1] 2 3 :MONitor:TYPE?
Example	TRAC:MON:TYPE WRIT TRAC:MON:TYPE?
Notes	WRITe = Clear Write AVERAge = Average MAXHold = Maximum Hold MINHold = Minimum Hold

Preset	WRITE
State Saved	Saved in instrument state.
Range	WRITE AVERage MAXHold MINHold for traces 1 through 3
Instrument S/W Revision	Prior to A.02.00

Update

Toggles a trace state between Update and Off. The Off selection makes the trace inactive (or a stored trace). This does not affect whether the trace is visible or not. Use the Display Show/Blank function to change the trace visibility.

Key Path	Trace/Detector
Mode	All except SA and BASIC
Remote Command	:TRACe [1] 2 3 :MONitor:UPDate [:STATE] ON OFF 0 1 :TRACe [1] 2 3 :MONitor:UPDate [:STATE] ?
Example	TRAC3:MON:UPD OFF TRAC3:MON:UPD?
Preset	ON
State Saved	Saved in instrument state.
Range	On Off (View)
Instrument S/W Revision	Prior to A.02.00

Display

Controls the visibility of a trace. In **Blank**, traces do not display nor appear on printouts but are otherwise unaffected. They may be queried and markers may be placed on them

Key Path	Trace/Detector
Mode	All except SA and BASIC
Remote Command	:TRACe [1] 2 3 :MONitor:DISPlay [:STATE] ON OFF 0 1 :TRACe [1] 2 3 :MONitor:DISPlay [:STATE] ?
Example	TRAC:MON:DISP ON TRAC:MON:DISP?
Preset	ON OFF OFF
State Saved	Saved in instrument state.
Range	Show Blank
Instrument S/W Revision	Prior to A.02.00

Detector

Accesses a menu of functions that enable you to control the detectors for the current measurement. The following choices are available:

Auto — the detector selected depends on marker functions, trace functions, average type, and the trace averaging function.

- Normal — the detector determines the peak of the CW-like signals, and it yields alternating maximums and minimums of noise-like signals. This is also referred to as Rosenfell detection.
- Average — the detector determines the average of the signal within the sweep points. The averaging method depends upon the Average Type selection (voltage, power or log scales).
- Peak — the detector determines the maximum of the signal within the sweep points.
- Sample — the detector indicates the instantaneous level of the signal at the center of the sweep points represented by each display point.
- Negative Peak — the detector determines the minimum of the signal within the sweep points.

In swept analysis, the time interval of the data collection for the display sweep points also represents a frequency interval. In FFT analysis, the sweep points represent just a frequency interval. The detector determines the relationship between the spectrum computed by the FFT and the single data point displayed for the sweep points.

Key Path	Trace/Detector
Mode	All except SA and BASIC
Remote Command	[:SENSE] :MONitor:DETEctor:TRACe AVERage NEGative NORMal POSitive SAMPlE [:SENSE] :MONitor:DETEctor:TRACe?
Example	MON:DET:TRAC NORM MON:DET:TRAC?
Notes	The query returns a name that corresponds to the detector type as shown below. String Returned Definition NORM Normal AVER Average POS Peak SAMP Sample NEG Negative Peak
Dependencies/Couplings	When the Detector choice is Auto, the detector selected depends on average type.

Preset	NORMal
State Saved	Saved in instrument state.
Range	Normal Average(RMS) Peak Sample Negative Peak
Instrument S/W Revision	Prior to A.02.00

Auto

Sets the detector for the currently selected trace to Auto. When the detector choice is Auto, the analyzer selects the detector. The selected detector depends on marker functions, trace functions, and trace averaging functions for the current measurement.

Key Path	Trace/Detector Trace/Detector, Detector
Mode	All except SA and BASIC
Remote Command	[:SENSE] :MONitor:DETECTOR:AUTO ON OFF 1 0 [:SENSE] :MONitor:DETECTOR:AUTO?
Example	MON:DET:AUTO OFF MON:DET:AUTO?
Dependencies/Couplings	When the Detector choice is Auto, the detector selected depends on average state and trace type.
Preset	ON
State Saved	Saved in instrument state.
Range	Auto Man
Instrument S/W Revision	Prior to A.02.00

Clear Trace

Clears the selected trace from the display.

Key Path	Trace/Detector
Mode	All except SA and BASIC
Remote Command	:TRACe:MONitor:CLEAr [TRACE1] TRACE2 TRACE3
Example	TRAC:MON:CLE
Instrument S/W Revision	Prior to A.02.00
Mode	All except SA and BASIC
Remote Command	:DISPlay:MONitor:VIEW:WINDow:TRACe [1] 2 3 :CLEAr

Monitor Spectrum Measurement Trace/Detector

Example	DISP:MON:VIEW:WIND:TRAC:CLE
Instrument S/W Revision	Prior to A.02.00

Clear All Traces

Clears all traces from the display.

Key Path	Trace/Detector
Mode	All except SA and BASIC
Remote Command	:TRACe:MONitor:CLEAr:ALL
Example	TRAC:MON:CLE:ALL
Instrument S/W Revision	Prior to A.02.00

View/Display

Accesses a menu of functions that enable you to control certain functions related to the display of the analyzer.

There is a single trace view for this measurement.

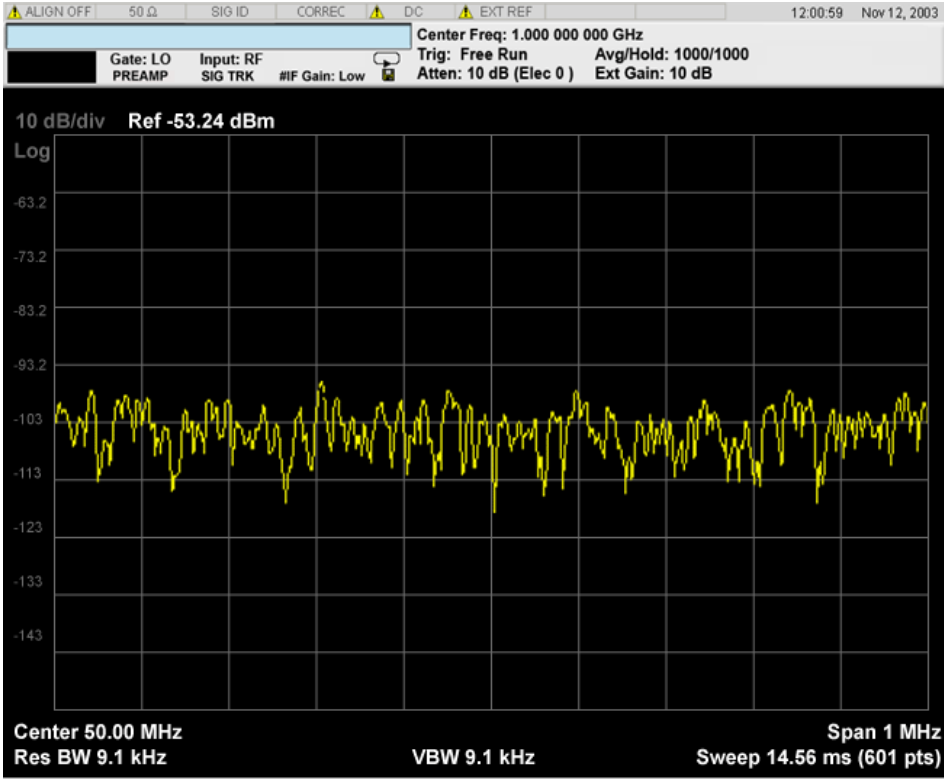

The measurement has no results, but has a number of features that make it flexible and simple to use.

Key Path	Front-panel key
Instrument S/W Revision	Prior to A.02.00

Display

Accesses a menu of functions that enable you to set the display parameters.

See “Display” on page 697 in the "Common Measurement Functions" section for more information.

Key Path	View/Display
Instrument S/W Revision	Prior to A.02.00

The Spot Frequency measurement continuously measures the phase noise at a single offset frequency (relative to the carrier) specified by the spot offset frequency.

This topic contains the following sections:

[“Spot Frequency Remote Commands” on page 301](#)

[“Remote Results” on page 301](#)

Spot Frequency Remote Commands

If a :FETCh command is received before all 101 measurement points are completed, the results will be returned after they are completed. READ and MEASure commands restart the measurement and return values only after all 101 measurement points have been completed.

The following commands are used to retrieve the measurement results:

:CONFigure:SFRequency

:CONFigure:SFRequency:NDEfault

:INITiate:SFRequency

:FETCh:SFRequency [n] ?

:READ:SFRequency [n] ?

:MEASure:SFRequency [n] ?

Remote Results

Command	Results Returned
Not specified or n=1	Returns six values value: Carrier Power (dBm) Carrier Frequency (Hz) Carrier Frequency Initial (Hz) Carrier Frequency Delta (Hz) (Upper/Right) SSB Noise (dBc/Hz) Average SSB Noise (dBc/Hz)
n=2	Returns 101 points of the phase noise of the carrier.trace
n=3	Returns 101 points of carrier frequencies trace.
n=4	Returns 101 points of carrier powers trace.

Key Path	Meas
Instrument S/W Revision	Prior to A.02.00

AMPTD Y Scale

Accesses a menu of functions that allow you to set the vertical scale parameters.

See ““Amplitude Y Scale (AMPTD Y Scale)” on page 443” in the section “Common Measurement Functions” for more information.

Key Path	Front-panel key
Instrument S/W Revision	Prior to A.02.00

Ref Value

Sets the absolute power reference value. However, since the Auto Scaling is defaulted to On, this value is automatically determined by the measurement result. When you set a value manually, Auto Scaling automatically changes to Off.

Key Path	AMPTD Y Scale
Instrument S/W Revision	Prior to A.02.00

Phase Noise Window

Allows the Y Reference value to be set for the Phase Noise graph.

Remote Command	:DISPlay:SFRequency:VIEW[1]:WINDow[1]:TRACe:Y[:SCALe]:RLEVel <real> :DISPlay:SFRequency:VIEW[1]:WINDow[1]:TRACe:Y[:SCALe]:RLEVel?
Dependencies/Couplings	When the Auto Scaling is On, this value is automatically determined by the measurement result. When you set a value manually, Auto Scaling automatically changes to Off.
Example	:DISP:SFR:VIEW:WIND:TRAC:Y:RLEV 0 :DISP:SFR:VIEW:WIND:TRAC:Y:RLEV?
Key Path	AMPTD Y Scale
Mode	PN
Preset	-50
State Saved	Saved in instrument state.
Min	-200
Max	10.0
Instrument S/W Revision	Prior to A.02.00

Frequency Delta Window

Allows the Y Reference value to be set for the Frequency Delta graph.

Remote Command	:DISP:SFRequency:VIEW[1]:WINDow2:TRACe:Y[:SCALe]:RLEVel <freq> :DISP:SFRequency:VIEW[1]:WINDow2:TRACe:Y[:SCALe]:RLEVel?
Dependencies/Couplings	When the Auto Scaling is On, this value is automatically determined by the measurement result. When you set a value manually, Auto Scaling automatically changes to Off.
Example	:DISP:SFR:VIEW:WIND2:TRAC:Y:RLEV 0 :DISP:SFR:VIEW:WIND2:TRAC:Y:RLEV?
Key path	AMPTD Y Scale
Mode	PN
Preset	0.0 Hz
State Saved	Saved in instrument state.
Min	-30 GHz
Max	30 GHz
Instrument S/W Revision	Prior to A.02.00

Attenuation

This menu controls both the electrical and mechanical attenuators and their interactions. The value read back on the key in square brackets is the current Total (Elec + Mech) attenuation. When in Pre-Adjust for Min Clip mode, this value can change at the start of every measurement.

See AMPTD Y Scale, “[Attenuation](#)” on page 443 in the section “Common Measurement Functions” for more information.

Key Path	AMPTD Y Scale
Instrument S/W Revision	Prior to A.02.00

Scale/Div

Set the value for the logarithmic display, vertical scale, units per division. When Auto Scale default is On, this value is automatically determined by the measurement result. When setting a value manually, Auto Scale is automatically turned Off.

Key Path	AMPTD Y Scale
Instrument S/W Revision	Prior to A.02.00

Spot Frequency Measurement AMPTD Y Scale

Phase Noise Window

Allows the Y Scale per Division to be set for the Phase Noise graph.

When set to **AUTO** the Scale/Div is adjusted such that the trace is visible within the center 80% of the horizontal display, that is, $\text{Scale/Div} = (\text{Max Phase Noise Trace Result} - \text{Min Phase Noise Trace Result})/8.0$

Remote Command	<code>:DISPlay:SFRequency:VIEW [1] :WINDow [1] :TRACe:Y [:SCALe] : PDIVision <rel_ampl></code> <code>:DISPlay:SFRequency:VIEW [1] :WINDow [1] :TRACe:Y [:SCALe] : PDIVision?</code>
Dependencies/Couplings	When Auto Scale is On, this value is automatically determined by the measurement result. When you set a value manually, Auto Scale automatically changes to Off .
Example	<code>:DISP:SFR:VIEW:WIND:TRAC:Y:PDIV 10</code> <code>:DISP:SFR:VIEW:WIND:TRAC:Y:PDIV?</code>
Key Path	AMPTD Y Scale
Mode	PN
Preset	10.0
State Saved	Saved in instrument state.
Min	0.1 dB
Max	20 dB
Instrument S/W Revision	Prior to A.02.00

Frequency Delta Window

Allows you to set the Y Scale per Division for the Frequency Delta graph.

Remote Command	<code>:DISPlay:SFRequency:VIEW [1] :WINDow2 :TRACe:Y [:SCALe] : PDIVision <freq></code> <code>:DISPlay:SFRequency:VIEW [1] :WINDow2 :TRACe:Y [:SCALe] : PDIVision?</code>
Dependencies/Couplings	When Auto Scale is On, this value is automatically determined by the measurement result. When you set a value manually, Auto Scale automatically changes to Off .
Example	<code>:DISP:SFR:VIEW:WIND2:TRAC:Y:PDIV 10</code> <code>:DISP:SFR:VIEW:WIND2:TRAC:Y:PDIV?</code>
Key path	AMPTD Y Scale
Mode	PN

Preset	10 Hz
State Saved	Saved in instrument state.
Min	0.001Hz
Max	3 GHz
Instrument S/W Revision	Prior to A.02.00

Presel Center

When this key is pressed, the centering of the preselector filter is adjusted to optimize the amplitude accuracy at the frequency of the selected marker.

See [“Presel Center” on page 455](#) under AMPTD Y Scale in the section "Common Measurement Functions" for more information.

Key Path	AMPTD/Y Scale
Instrument S/W Revision	Prior to A.02.00

Presel Adjust

Allows you to manually adjust the preselector filter frequency to optimize its response to the signal of interest. This function is only available when Presel Center is available.

See [“Preselector Adjust” on page 456](#) under AMPTD Y Scale in the section "Common Measurement Functions" for more information.

Key Path	AMPTD/Y Scale
Instrument S/W Revision	Prior to A.02.00

Internal Preamp

Accesses a menu that enables you to control the internal preamplifiers. Turning Internal Preamp on gives a better noise figure, but a poorer inter-modulation distortion (TOI) to noise floor dynamic range. You can optimize this setting for your particular measurement. See AMPTD Y Scale, [“Internal Preamp” on page 458](#) in the section “Common Measurement Functions” for more information.

Key Path	AMPTD/Y Scale, More
Instrument S/W Revision	Prior to A.02.00

Auto Scale

Allows you to toggle the **Auto Scale** function between **On** and **Off**.

Remote Command	:DISPlay:SFRequency:VIEW:WINDow [1] 2 : TRACe:Y [:SCALE] : COUPle 0 1 OFF ON :DISPlay:SFRequency:VIEW:WINDow [1] 2 : TRACe:Y [:SCALE] : COUPle?
Dependencies/Couplings	When Auto Scale is On , upon pressing the Restart front-panel key, this function automatically determines the scale per division and reference values based on the measurement results. When you set a value for either Scale/Div or Ref Value manually, Auto Scale automatically changes to Off .
Example	:DISP:SFR:VIEW:WIND:TRAC:Y:COUP ON :DISP:SFR:VIEW:WIND:TRAC:Y:COUP?
Key path	AMPTD Y Scale, More
Mode	PN
Preset	OFF
State Saved	Saved in instrument state.
Range	On Off
Instrument S/W Revision	Prior to A.02.00

Auto Couple

See “**AUTO COUPLE**” on page 461 in the section "Common Measurement Functions" for more information.

BW

The BW key opens the BW menu, which contains keys to control the Resolution Bandwidth and Video Bandwidth functions of the instrument.

Key Path	Front-panel key
Instrument S/W Revision	Prior to A.02.00

Res BW

Allows you to read back the resolution bandwidth setting or mode. The parameter is read only.

The Res BW is automatically calculated using the following calculation:

$$\text{Res BW} = \text{SpotOffset} * (\text{RBWSpotOffsetRatio} / 100.0);$$

Remote Command	<code>[:SENSE] :SFRequency:BA NDwidth[:RESolution] ?</code> <code>[:SENSE] :SFRequency:BA NDwidth[:RESolution] :AUTO?</code>
Example	<code>:SFR:BWID:RES?</code> <code>:SFR:BAND:AUTO?</code>
Key path	BW
Mode	PN
Notes	Read Only
Preset	Automatically calculated
State Saved	No
Min	Hardware Min Limit
Max	Hardware Max Limit
Instrument S/W Revision	Prior to A.02.00

Video BW

Allows you to read the video bandwidth setting or mode. The parameter is read only.

The Video BW is automatically calculated using the following calculation:

$$\text{Video BW} = \text{Res BW} * \text{VBW:3dB RBW}$$

Remote Command	<code>[:SENSE] :SFRequency:BA NDwidth:VIDeo?</code> <code>[:SENSE] :SFRequency:BA NDwidth:VIDeo:AUTO?</code>
Dependencies/Couplings	Coupled to the VBW:3dB RBW

Example	:SFR:BWID:VID? :SFR:BAND:VID:AUTO?
Key path	BW
Mode	PN
Notes	Read Only
Preset	Automatically calculated
State Saved	No
Min	Hardware Min Limit
Max	Hardware Max Limit
Instrument S/W Revision	Prior to A.02.00

VBW:3dB RBW

Allows you to specify the video bandwidth to resolution bandwidth ratio.

Remote Command	[:SENSe] :SFRrequency:BA NDwidth:VIDeo:RATio <real> [:SENSe] :SFRrequency:BA NDwidth:VIDeo:RATio? [:SENSe] :SFRrequency:BA NDwidth:VIDeo:RATio:AUTO ON OFF 1 0 [:SENSe] :SFRrequency:BA NDwidth:VIDeo:RATio:AUTO?
Example	:SFR:BWID:VID:RAT 1 SFR:BAND:VID:RAT:AUTO?
Key path	Frequency
Mode	PN
Preset	0.1 ON
State Saved	Saved in instrument state.
Min	0.001
Max	10.0
Instrument S/W Revision	Prior to A.02.00

Cont

See “[Cont \(Continuous Measurement/Sweep\)](#)” on page 465 in the section "Common Measurement Functions" for more information.

FREQ Channel

See “[FREQ Channel](#)” on page 467 in the section "Common Measurement Functions" for more information.

Input/Output

See “[Input/Output](#)” on page 471 in the section "Common Measurement Functions" for more information.

Marker

There is no 'Marker' functionality supported in Phase Noise Spot Frequency. The front-panel key displays a blank menu when pressed.

Key Path	Front-panel key
Instrument S/W Revision	Prior to A.02.00

Marker Fctn

There are no 'Marker Functions' supported in Phase Noise Spot Frequency. The front-panel key displays a blank menu when pressed.

Key Path	Front-panel key
Instrument S/W Revision	Prior to A.02.00

Marker To

There is no Marker To functionality supported in Phase Noise Spot Frequency. The front-panel key displays a blank menu when pressed.

Key Path	Front-panel key
Instrument S/W Revision	Prior to A.02.00

Meas

See “[Meas](#)” on page 535 in the section "Common Measurement Functions" for more information.

Meas Setup

Displays the measurement setup menu for the currently selected measurement.

Key Path	Front-panel key
Instrument S/W Revision	Prior to A.02.00

Avg/Hold Num

Allows you to specify the number of measurements made when calculating the average result, or to turn averaging on or off.

Remote Command	<code>[:SENSE] :SFRequency:AVERage:COUNT <integer></code>
	<code>[:SENSE] :SFRequency:AVERage:COUNT?</code>
	<code>[:SENSE] :SFRequency:AVERage [:STATe] OFF ON 0 1</code>
	<code>[:SENSE] :SFRequency:AVERage [:STATe] ?</code>

Example	<code>:SFR:AVER:COUN 10</code>
	<code>:SFR:AVER:COUN?</code>
	<code>:SFR:AVER ON</code>
	<code>:SFR:AVER?</code>

Key path	Meas Setup
Mode	PN
Preset	10
	OFF
State Saved	Saved in instrument state.
Min	1
Max	1000
Instrument S/W Revision	Prior to A.02.00

Avg Mode

Selects the type of termination control used for the averaging function. This determines the averaging action after the specified number of acquisitions (average count) is reached.

Avg Mode (Exponential) causes the measurement to keep on measuring with averaging the result exponentially.

Avg Mode (Repeat) causes the measurement to reset the average counter each time the specified number

Spot Frequency Measurement Meas Setup

of averages is reached.

Remote Command	<code>[:SENSE] :SFRequency:AVERage:TCONtrol EXPOnential REPeat</code> <code>[:SENSe] :SFRequency:AVERage:TCONtrol?</code>
Example	<code>:SFR:AVER:TCON REP</code> <code>:SFR:AVER:TCON?</code>
Key path	Meas Setup
Mode	PN
Preset	EXPOnential
State Saved	Saved in instrument state.
Range	EXP Repeat
Instrument S/W Revision	Prior to A.02.00

Meas Type

This parameter determines whether to measure the Phase Noise of a signal or the DANL Floor of the analyzer. Phase Noise is the default, and this is the intended use of the measurement, however it can be useful to measure the DANL Floor of the analyzer and compare this with the Phase Noise. You can do this by measuring the DANL Floor, and storing it in the reference trace using the softkeys under the display menu.

In DANL Floor mode, the analyzer measures the noise level by maximizing the attenuation. It is accurate enough for most purposes, but removing the input signal from the analyzer before measuring the noise level can be more accurate when the signal level is high.

Remote Command	<code>[:SENSE] :SFRequency:METhod DANL PN</code> <code>[:SENSe] :SFRequency:METhod?</code>
Example	<code>:SFR:METH PN</code> <code>:SFR:METH?</code>
Key path	Meas Setup
Mode	PN
Preset	PN
State Saved	Saved in instrument state.
Range	DANL Phase Noise
Instrument S/W Revision	Prior to A.02.00

Spot Offset

Specifies the frequency offset at which the phase noise is to be measured.

Remote Command	<code>[:SENSe] :SFRequency :SOFFset <freq></code> <code>[:SENSe] :SFRequency :SOFFset ?</code>
Example	<code>:SFR:SOFF 10000</code> <code>:SFR:SOFF?</code>
Key path	Meas Setup
Mode	PN
Preset	10 kHz
State Saved	Saved in instrument state.
Min	10 Hz
Max	Hardware Dependent: Opt503 = 3.699999995 GHz Opt508 = 8.499999995 GHz Opt513 = 13.799999995 GHz Opt526 = 26.999999995 GHz
Instrument S/W Revision	Prior to A.02.00

Table Index

Allows you to select a result (from the last 101), when in numeric view.

Remote Command	<code>:DISPlay:SFRequency:VIEW2:WINDow[1]:TRACe:Y[:SCALe]:RLEVel <integer></code> <code>:DISPlay:SFRequency:VIEW2:WINDow[1]:TRACe:Y[:SCALe]:RLEVel?</code>
Key path	Meas Setup
Mode	PN
Notes	Softkey is unavailable when the selected view is “Graphical”
Preset	1
State Saved	Saved in instrument state.
Min	1
Max	101

Advanced

Accesses advanced features. These features are recommended for use only by advanced users.

Key Path	Meas Setup
Instrument S/W Revision	Prior to A.02.00

RBW/Spot Offset

This command allows you to specify the Resolution Bandwidth as a percentage of the offset frequency, to minimize the variance without impacting measurement speed.

Remote Command	<code>[:SENSe] :SFRequency :SOFFset :BANDwidth [:RESolution] :RATio <real></code> <code>[:SENSe] :SFRequency :SOFFset :BANDwidth [:RESolution] :RATio?</code>
Dependencies/Couplings	Adjusts “BW, Res BW”
Example	<code>:SFR:SOFF:BAND:RAT 10</code> <code>:SFR:SOFF:BAND:RAT?</code>
Key path	Meas Setup, Advanced
Mode	PN
Preset	10
State Saved	Saved in instrument state.
Min	1
Max	100
Instrument S/W Revision	Prior to A.02.00

Meas Preset

Restores all the measurement parameters to their default values.

Remote Command	<code>:CONFIgure :SFRequency</code>
Dependencies/Couplings	Selecting Meas Preset restores all measurement parameters to these default values
Example	<code>:CONF:SFR</code>
Key path	Meas Setup
Mode	PN
Instrument S/W Revision	Prior to A.02.00

Mode

See [“Mode” on page 551](#) in the section "Common Measurement Functions" for more information.

Mode Setup

See “[Mode Setup](#)” on page 565 in the section "Common Measurement Functions" for more information.

Peak Search

There is no Peak Search functionality supported in Phase Noise Spot Frequency. The front-panel key displays a blank menu when pressed.

Key Path	Front-panel key
Instrument S/W Revision	Prior to A.02.00

Recall

See “[Recall](#)” on page 569 in the section "Common Measurement Functions" for more information.

Restart

See “Restart” on page 591 in the section "Common Measurement Functions" for more information.

Save

See “[Save](#)” on page 593 in the section "Common Measurement Functions" for more information.

Single

See “[Single \(Single Measurement/Sweep\)](#)” on page 619 in the section "Common Measurement Functions" for more information.

Source

There is no Source functionality supported in Phase Noise Spot Frequency measurement. The front-panel key displays a blank menu when pressed.

Key Path	Front-panel key
Instrument S/W Revision	Prior to A.02.00

SPAN X Scale

There is no SPAN X Scale functionality supported in Phase Noise Spot Frequency measurement. The front-panel key displays a blank menu when pressed.

Key Path	Front-panel key
Instrument S/W Revision	Prior to A.02.00

Sweep/Control

See “Sweep / Control” on page 625 in the section "Common Measurement Functions" for more information.

Sweep Time

Allows you to specify the sweep time.

When sweep time mode is set to auto the sweep time is calculated as:

sweeptime = maxOf(1e-3, (4.22² / rbw)) thus,

sweeptime = maxOf(1e-3, (17.8084 / rbw))

Remote Command [:SENSe]:SFRrequency:SWEep:TIME <time>
 [:SENSe]:SFRrequency:SWEep:TIME?
 [:SENSe]:SFRrequency:SWEep:TIME:AUTO ON|OFF|1|0
 [:SENSe]:SFRrequency:SWEep:TIME:AUTO?

Example :SFR:SWE:TIME 0.01
 :SFR:SWE:TIME?
 :SFR:SWE:TIME:AUTO ON
 :SFR:SWE:TIME:AUTO?

Key path	Sweep/Control
Mode	PN
Preset	Automatically calculated
State Saved	Saved in instrument state.
Min	1 ms
Max	4000
Instrument S/W Revision	Prior to A.02.00

Trace/Detector

No Trace/Detector settings are available for this measurement. You may query the measurement for a read-only result as follows:

Queries and returns the detection mode.

NOTE This parameter is query only and always set to average detector.

Remote Command	[:SENSe] :SFRrequency:DETEctor[:FUNction]?
Example	:SFR:DET?
Mode	PN
Notes	Read Only
Preset	AVERage
State Saved	Saved in instrument state.
Range	AVERage
Instrument S/W Revision	Prior to A.02.00

Trigger

Selects the trigger source and trigger setup functionality. See [“Trigger” on page 641](#) in the section "Common Measurement Functions" for information about all keys in this menu.

Key Path	Front-panel key
Instrument S/W Revision	Prior to A.02.00

View/Display

Accesses a menu of functions that enable you to set the display parameters.

For more information see: [“Graphical View” on page 333](#) and [“Numerical \(Table View\)” on page 335](#).

Key Path	Front-panel key
Instrument S/W Revision	Prior to A.02.00

Display

Accesses a menu of functions that enable you to set the display parameters.

See [“Display” on page 697](#) in the section "Common Measurement Functions" for more information.

Key Path	View/Display
Instrument S/W Revision	Prior to A.02.00

Graphical View

Selects a graphical display of Phase Noise results (default display) with 2 graphs: a scrolling display of Phase Noise vs. Sample Number at the offset frequency and a Delta Frequency vs. Frequency graph showing signal tracking. A table of numerical results for SSB phase noise, carrier frequency and carrier power is shown below the graphs.

The yellow trace represents the measured Phase Noise of each measurement cycle. The purple trace represents the averaged value of Phase Noise during measurement cycles.

See [“Display” on page 697](#) for more information.

Key Path	View/Display
Instrument S/W Revision	Prior to A.02.00

Spot Frequency Measurement View/Display

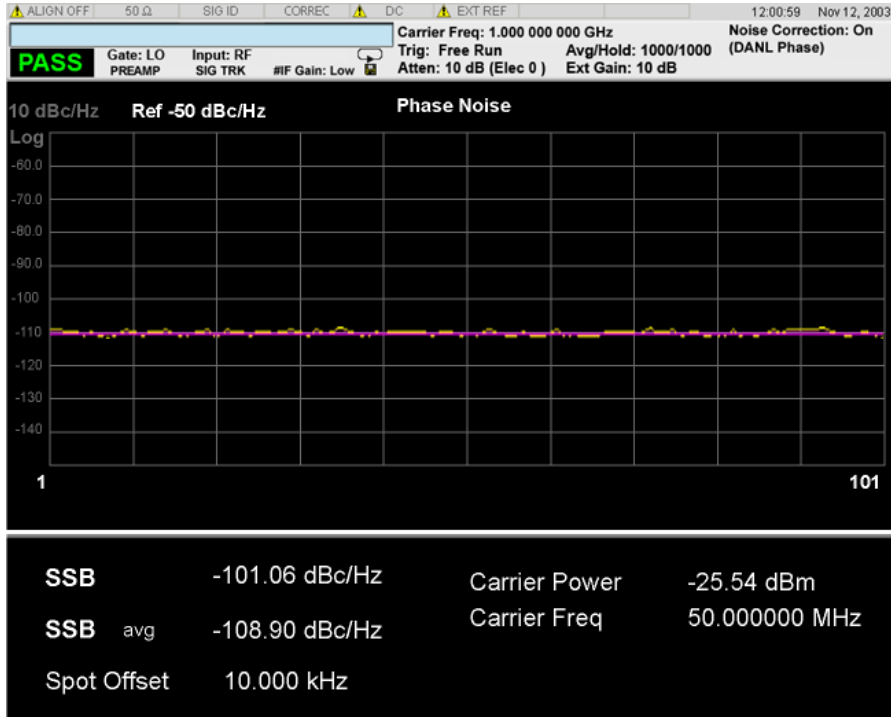

The Carrier Frequency graph denotes Frequency vs. Time (number of measurements), plotting the Frequency Drift of the carrier. This view appears when Signal Tracking is enabled. Carrier Freq (Initial) and Carrier Freq Δ are also shown in the results summary.

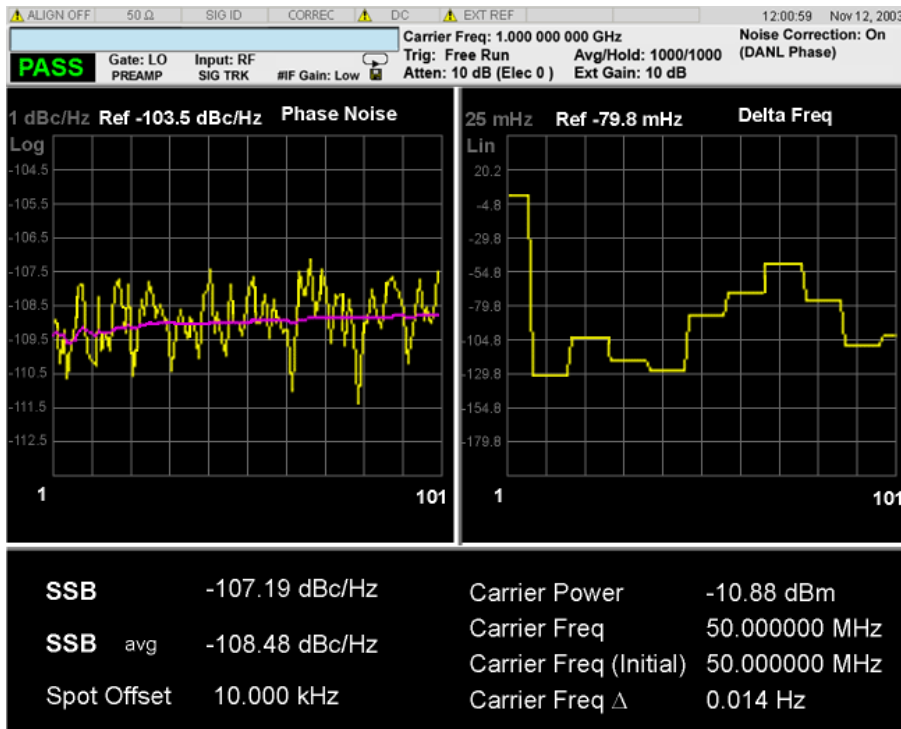

Numerical (Table View)

The Numerical (Table View) allows the user to view a list of spot offsets and results together with a visual trace of the last 100 samples measured. Use the scroll bar to view results outside the window.

See “Display” on page 697i for more information.

Key Path **View/Display**
Instrument S/W Revision Prior to A.02.00

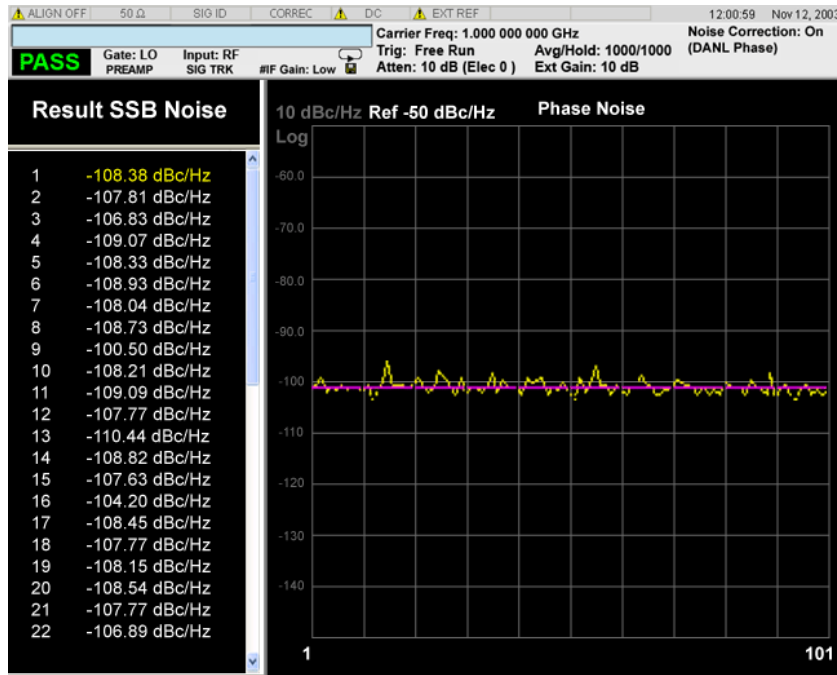

View – Selection by Enum (Remote Command Only)

Allows you to select the active view by enum.

For more information see: “Graphical View” on page 333 and “Numerical (Table View)” on page 335

Remote Command :DISPlay:SFRequency:VIEW[:SElect] GRAPh|TABLE
:DISPlay:SFRequency:VIEW[:SElect] ?

Example :DISP:SFR:VIEW:SEL GRAP
:DISP:SFR:VIEW:SEL?

Mode PN

Preset GRAPh

State Saved Saved in instrument state.

Range Graph | Table

Instrument S/W Revision Prior to A.02.00

View – Selection by number (Remote Command Only)

Allows you to select the active view by number.

For more information see: “Graphical View” on page 333 and “Numerical (Table View)” on page 335

Remote Command	:DISPlay:SFRequency:VIEW:NSElect 1 2 :DISPlay:SFRequency:VIEW:NSElect?
Dependencies/Couplings	Changing parameter of "View" (GRAPh TABLE) also changes this parameter. 1 corresponds to GRAPh and 2 corresponds to TABLE.
Example	:DISP:SFR:VIEW:NSEL 1 :DISP:SFR:VIEW:NSEL?
Mode	PN
Preset	1
State Saved	Saved in instrument state.
Range	1 2
Instrument S/W Revision	Prior to A.02.00

Measurement Results

SSB Noise This is a measure of the lower/left and upper/right sideband RMS Noise in dBc/Hz

SSB Noise Average This is a measure of the average lower/left and upper/right sideband RMS Noise in dBc/Hz

Carrier Power This result represents the power at the carrier frequency in dBm.

Carrier Frequency This result represents the last measured carrier frequency in Hz.

Carrier Frequency (Initial) This result represents the initial measured carrier frequency in Hz.

Carrier Frequency Delta This result represents the carrier frequency drift $C_f - C_{f \text{ initial}}$ in Hz.

NOTE Due to formatting it is possible that the Carrier Frequency and Carrier Frequency (initial) may be identically displayed, however a small delta may reside.

This topic contains the following sections:

[“Log Plot Remote Commands” on page 337](#)

[“Remote Command Results” on page 337](#)

[“Measurement Description” on page 338](#)

Log Plot Remote Commands

The following commands are used to retrieve the measurement results:

```
:CONFigure:LPLot
:CONFigure:LPLot:NDEFault
:INITiate:LPLot
:FETCh:LPLot [n] ?
:READ:LPLot [n] ?
:MEASure:LPLot [n] ?
```

Remote Command Results

n	Results Returned
Not specified or n=1	Returns seven comma-separated scalar values corresponding following measurement results: <ol style="list-style-type: none"> 1. Carrier Power (dBm) 2. Carrier Frequency (Hz) 3. RMS Phase Noise over the entire smoothed trace (degrees) 4. RMS Phase Noise over the entire smoothed trace (radians) 5. Residual FM over the entire smoothed trace (Hz) 6. Spot Noise at the Start Offset Frequency (dBc/Hz) 7. Spot Noise at the Stop Offset Frequency (dBc/Hz)
n=2	Returns three comma-separated scalar values corresponding to the following measurement values: <ol style="list-style-type: none"> 1. Number of x/y value pairs in Trace 1 2. Number of x/y value pairs in Trace 2 3. Number of x/y value pairs in Trace 3

n Results Returned

- n=3 Returns a comma-separated list of the data points from Trace 1. The number of data points in the trace depends on the implementation and the frequency range being measured. This can be found by using the :LLOT2? command (above):
- n=4 Returns a comma-separated list of the data points from Trace 2. The number of data points in the trace depends on the implementation and the frequency range being measured. This can be found by using the :LLOT2? command (above):
- n=5 Returns a comma-separated list of the data points from Trace 3. The number of data points in the trace depends on the implementation and the frequency range being measured. This can be found by using the :LLOT3? command (above):
- n=6 Returns a comma-separated list of the data points which represent the values found on each trace at each decade offset frequency.
- The points in the list are returned in the following order: Frequency Offset, Trace number 1 (yellow) amplitude, Trace number 2 (cyan blue) amplitude and Trace number 3 (magenta pink) amplitude.
- Any data points that do not have an associated trace, or any data points that are not covered by a particular frequency return SCPI_NAN (Not A Number). The total number of values listed can be calculated by multiplying the number of decades by 4, and adding 4.

Measurement Description

The Log Plot measurement makes a phase noise measurement over the range of frequencies specified by the minimum and maximum offset frequencies. After the measurement is completed, the phase noise plot is displayed.

Key Path	Meas
Instrument S/W Revision	Prior to A.02.00

AMPTD Y Scale

Accesses a menu of functions that allow you to set vertical display scale parameters.

Key Path	Front-panel key
Instrument S/W Revision	Prior to A.02.00

Ref Value

Determines the ref level to be used in measuring the log plot.

Remote Command	:DISPlay:LPLot:VIEW[1]:WINDow[1]:TRACe:Y[:SCALe] :RLEVel <real> :DISPlay:LPLot:VIEW[1]:WINDow[1]:TRACe:Y[:SCALe] :RLEVel?
Example	:DISP:LPL:VIEW:WIND:TRAC:Y:RLEV -70 :DISP:LPL:VIEW:WIND:TRAC:Y:RLEV?
Key Path	AMPTD/Y Scale
Mode	PN
Preset	-70
State Saved	Saved in instrument state.
Min	-200
Max	200.0
Instrument S/W Revision	Prior to A.02.00

Attenuation

This menu controls both the electrical and mechanical attenuators and their interactions. The value read back on the key in square brackets is the current Total (Elec + Mech) attenuation. When in Pre-Adjust for Min Clip mode, this value can change at the start of every measurement. See [“Attenuation” on page 443](#) under “AMPTD Y Scale” for more information.

Key Path	AMPTD/Y Scale
Instrument S/W Revision	Prior to A.02.00

Scale/Div

Determines the displayed amplitude range in the log plot graph. Each y-division in the graticule is worth

Log Plot Measurement AMPTD Y Scale

this amount, so the total is 10x this amount.

Remote Command	:DISPlay:LPLot:VIEW[1]:WINDow[1]:TRACe:Y[:SCALE]: PDIVision <rel_ampl> :DISPlay:LPLot:VIEW[1]:WINDow[1]:TRACe:Y[:SCALE]: PDIVision?
Example	:DISP:LPL:VIEW:WIND:TRAC:Y:PDIV 10 :DISP:LPL:VIEW:WIND:TRAC:Y:PDIV?
Key Path	AMPTD Y Scale
Mode	PN
Preset	10.0
State Saved	Saved in instrument state.
Min	0.1 dB
Max	20 dB
Instrument S/W Revision	Prior to A.02.00

Presel Center

When this key is pressed, the centering of the preselector filter is adjusted to optimize the amplitude accuracy at the frequency of the selected marker.

See [“Presel Center” on page 455](#) under “AMPTD Y Scale” for more information.

Key Path	AMPTD/Y Scale
Instrument S/W Revision	Prior to A.02.00

Presel Adjust

Allows you to manually adjust the preselector filter frequency to optimize its response to the signal of interest. This function is only available when Presel Center is available.

See [“Preselector Adjust” on page 456](#) under “AMPTD Y Scale” for more information.

Key Path	AMPTD/Y Scale
Instrument S/W Revision	Prior to A.02.00

Internal Preamp

Accesses a menu that enables you to control the internal preamplifiers. Turning Internal Preamp on gives a better noise figure, but a poorer inter-modulation distortion (TOI) to noise floor dynamic range. You can optimize this setting for your particular measurement.

See ““Internal Preamp” on page 458” under “AMPTD Y Scale” for more information.

Key Path	AMPTD/Y Scale, More
Instrument S/W Revision	Prior to A.02.00

Ref Position

Positions the reference level at the top, center or bottom of the Y Scale display. Changing the reference position does not change the reference level value.

Remote Command	:DISPlay:LPLot:VIEW[1]:WINDow[1]:TRACe:Y[:SCALe] :RPOsition TOP CENTer BOTTom :DISPlay:LPLot:VIEW[1]:WINDow[1]:TRACe:Y[:SCALe] :RPOsition?
-----------------------	---

Example	:DISP:LPL:VIEW:WIND:TRAC:Y:RPOS TOP :DISP:LPL:VIEW:WIND:TRAC:Y:RPOS?
---------	---

Key Path	AMPTD Y Scale
Mode	PN
Preset	TOP
State Saved	Saved in instrument state.
Range	Top Ctr Bot
Instrument S/W Revision	Prior to A.02.00

Auto Couple

See “**AUTO COUPLE**” on page 461 in the section "Common Measurement Functions" for more information.

BW

There is no BW functionality for this measurement. The front-panel key displays a blank menu when pressed.

Key Path	Front-panel key
Instrument S/W Revision	Prior to A.02.00

Cont

See “[Cont \(Continuous Measurement/Sweep\)](#)” on page 465 in the section "Common Measurement Functions" for more information.

FREQ Channel

See “[FREQ Channel](#)” on page 467 in the section "Common Measurement Functions" for more information.

Input/Output

See “[Input/Output](#)” on page 471 in the section "Common Measurement Functions" for more information.

Marker

Accesses a menu that enables you to select, set up and control the markers for the current measurement. See “[Marker](#)” on page 529 in the section "Common Measurement Functions" for more information.

Key Path	Front-panel key
Instrument S/W Revision	Prior to A.02.00

Select Marker

Displays 12 markers available for selection.

Key Path	Marker
Instrument S/W Revision	Prior to A.02.00

Marker Type

Sets the marker control mode as described under Normal, Delta and Off, below. All interactions and dependencies detailed under the key description are enforced when the remote command is sent.

A number of results may be calculated using the extensive log plot marker support.

Marker Type	Description
Normal	Equivalent to a Spot Frequency marker, this allows you to place and adjust a marker upon the log trace and read the ‘Spot Noise’ value at any frequency.
Delta	Lets you compare and find the delta between any two spot frequency or noise values.
RMS Degree	Provides a simple method of setting up, calculating and displaying the rms degree result. This is generally calculated over a specific frequency range, and is therefore implemented as a ‘delta’ marker.
RMS Radian	Same as RMS Degree, although the result is displayed in Radians.
RMS Jitter	Provided you know the carrier frequency and the RMS Degree (or Radian) result you can calculate the RMS Jitter. This is provided as a convenience for users.
Residual FM	Provides a simple method of setting up, calculating and displaying the residual FM result. This is generally calculated over a specific frequency range, and is therefore implemented as a ‘delta’ marker.

You can have up to 12 independent markers in any combination of the above active at any time, although only the active marker is displayed in the top right hand side of the graph area. To display all of the

Log Plot Measurement Marker

active marker values at once, the Marker Table operation can be invoked.

Remote Command	:CALCulate:LPLot:MARKer [1] 2 3 4 5 6 7 8 9 10 11 12 : MODE POSition DELTA OFF :CALCulate:LPLot:MARKer [1] 2 3 4 5 6 7 8 9 10 11 12 : MODE?
Restriction and Notes	If the selected marker is Off, pressing Marker sets it to Normal and places it at the center of the screen on the trace determined by the Marker Trace rules. At the same time, Marker X Axis Value appears on the Active Function area. Default Active Function: the active function for the selected marker's current control mode. If the current control mode is Off, there is no active function and the active function is turned off. Active Function Display: the marker X axis value entered in the active function area displays the marker value to its full entered precision.
Remote Command Notes	NORMAL is changed to POSition in the new SA.
Example	:CALC:LPLot:MARK:MODE POS :CALC:LPLot:MARK:MODE?
Key Path	Marker
Mode	PN
Preset	OFF OFF OFF OFF OFF OFF OFF OFF OFF OFF OFF OFF
State Saved	Saved in instrument state.
Range	Normal Delta Off
Instrument S/W Revision	Prior to A.02.00

Marker X Axis Value (Remote Command Only)

Sets the marker X Axis value in the current marker X Axis Scale unit. It has no effect if the control mode is Off, but is the SCPI equivalent of entering an X value if the control mode is Normal or Delta.

Remote Command	:CALCulate:LPLot:MARKer [1] 2 3 4 5 6 7 8 9 10 11 12 : X <freq> :CALCulate:LPLot:MARKer [1] 2 3 4 5 6 7 8 9 10 11 12 : X?
MIN/MAX/DEF Support	Yes

Restriction and Notes	<p>If no suffix is sent, uses the fundamental units for the current marker X Axis Scale. If a suffix is sent that does not match the current marker X Axis Scale unit, an error “Invalid suffix” is generated. If the specified marker is Fixed and a Marker Function is on, error –221 “Settings conflict; cannot adjust Fixed marker while Marker Function is on” is generated.</p> <p>The query returns the marker’s absolute X Axis value if the control mode is Normal, or the offset from the marker’s reference marker if the control mode is Delta. The query is returned in the fundamental units for the current marker X Axis scale: Hz for Frequency and Inverse Time, seconds for Period and Time. If the marker is Off the response is Not A Number.</p>
Example	<p>CALC:LPLot:MARK3:X 10kHz</p> <p>CALC:LPLot:MARK3:X?</p>
Mode	PN
Preset	After a preset, all Markers are turned OFF, so Marker X Axis Value query returns Not A Number (NAN).
State Saved	No
Min	–9.9E37
Max	9.9E37
Instrument S/W Revision	Prior to A.02.00

Marker X Axis Position (Remote Command Only)

Sets the marker X position in trace points. It has no effect if the control mode is **Off**, but is the SCPI equivalent of entering a value if the control mode is **Normal** or **Delta** - except in trace points rather than X Axis Scale units. The entered value is immediately translated into the current X Axis Scale units for setting the value of the marker.

Remote Command	<pre>:CALCulate:LPLot:MARKer [1] 2 3 4 5 6 7 8 9 10 11 12 : X:POSition <integer></pre> <pre>:CALCulate:LPLot:MARKer [1] 2 3 4 5 6 7 8 9 10 11 12 : X:POSition?</pre>
MIN/MAX/DEF Support	Yes
Restriction and Notes	<p>If the specified marker is Fixed and a Marker Function is on, error –221 “Settings conflict; cannot adjust Fixed marker while Marker Function is on” is generated.</p> <p>The query returns the marker’s absolute X Axis value in trace points if the control mode is Normal, or the offset from the marker’s reference marker in trace points if the control mode is Delta. The value is returned as a real number, not an integer, corresponding to the translation from X Axis Scale units to trace points. If the marker is Off the response is Not A Number.</p>

Log Plot Measurement Marker

Example	CALC:LPLot:MARK10:X:POS 0 CALC:LPLot:MARK10:X:POS?
Mode	PN
Preset	After a preset, all Markers are turned OFF, so Marker X Axis Value query returns Not A Number (NAN).
State Saved	No
Min	-9.9E37
Max	9.9E37
Instrument S/W Revision	Prior to A.02.00

Marker Y Axis Value (Remote Command Only)

Queries Y Axis value in the current marker Y Axis unit. The Marker Y Axis unit depends on the selected marker mode and marker function.

Normal – dBc/Hz

Delta – dB

RMS Noise(Degree) – degree

RMS Noise(Radian) – radian

RMS Noise(Jitter) – second

Residual FM - Hz

Remote Command	:CALCulate:LPLot:MARKer [1] 2 3 4 5 6 7 8 9 10 11 12 : Y?
Restriction and Notes	The query returns the marker Y-axis result, if the control mode is Normal or Delta . If the marker is Off the response is Not A Number.
Example	CALC:LPLot:MARK11:Y?
Mode	PN
State Saved	No
Instrument S/W Revision	Prior to A.02.00

Properties

Accesses a menu that allows you to set marker properties and to access the marker trace menu.

Key Path	Marker
Instrument S/W Revision	Prior to A.02.00

Select Marker

Displays 12 markers available for selection.

Key Path	Marker, Properties
Instrument S/W Revision	Prior to A.02.00

Relative To

Selects the marker that the selected marker is relative to (its reference marker).

Remote Command	:CALCulate:LPLot:MARKer [1] 2 3 4 5 6 7 8 9 10 11 12 : REFerence <integer> :CALCulate:LPLot:MARKer [1] 2 3 4 5 6 7 8 9 10 11 12 : REFerence?
-----------------------	---

Restriction and Notes	A marker cannot be relative to itself so that choice is grayed out, and if sent from SCPI generates error –221: “Settings conflict; marker cannot be relative to itself.”
-----------------------	---

Remote Command Notes	When queried a single value is returned (the specified marker number’s relative marker). A marker cannot be relative to itself so that choice is grayed out, and, if sent from SCPI, generates error –221: “Settings conflict; marker cannot be relative to itself.” You must be in the Spectrum Analysis mode, GSM mode to use this command. Use INSTRument:SElect to set the mode.
----------------------	--

Example	CALC:LPLot:MARK:REF?
---------	----------------------

Key Path	Marker, Properties
Mode	PN
Preset	2 3 4 5 6 7 8 9 10 11 12 1
State Saved	Saved in instrument state.
Min	1
Max	12
Instrument S/W Revision	Prior to A.02.00

Marker Trace

Assigns the specified marker to the designated trace.

Remote Command	:CALCulate:LPLot:MARKer [1] 2 3 4 5 6 7 8 9 10 11 12 : TRACe <integer> :CALCulate:LPLot:MARKer [1] 2 3 4 5 6 7 8 9 10 11 12 : TRACe?
-----------------------	---

Log Plot Measurement Marker

Example	CALC:LPLot:MARK:TRAC 2 CALC:LPLot:MARK:TRAC?
Key Path	Marker
Mode	Int32
Preset	2
State Saved	Saved in instrument state.
Min	1
Max	3
Instrument S/W Revision	Prior to A.02.00

Marker Table

When set to On the display is split into a measurement window and a marker data display window.

Remote Command	:CALCulate:LPLot:MARKer:TABLE[:STATE] OFF ON 0 1 :CALCulate:LPLot:MARKer:TABLE[:STATE]?
Example	CALC:LPL:MARK:TABL 1 CALC:LPL:MARK:TABL?
Key Path	Marker
Mode	PN
Preset	OFF
State Saved	Saved in instrument state.
Range	On Off
Instrument S/W Revision	Prior to A.02.00

Couple Marker

When this function is true, moving any marker causes an equal X Axis movement of every other marker which is not **Off**, including **Fixed** markers. By “equal X Axis movement” we mean that we preserve the difference between each marker’s X Axis value (in the fundamental x-axis units of the trace that marker is on) and the X Axis value of the marker being moved (in the same fundamental x-axis units).

Remote Command	:CALCulate:LPLot:MARKer:COUple[:STATE] ON OFF 1 0 :CALCulate:LPLot:MARKer:COUple[:STATE]?
Example	:CALC:LPLot:MARK:COUP ON :CALC:LPLot:MARK:COUP?
Key Path	Marker

Mode	PN
Preset	OFF
State Saved	Saved in instrument state.
Range	On Off
Instrument S/W Revision	Prior to A.02.00

All Markers Off

Turns off all markers.

Remote Command	:CALCulate:LPLot:MARKer:AOff
Example	CALC:LPLot:MARK:AOff
Key Path	Marker
Mode	PN
Instrument S/W Revision	Prior to A.02.00

Marker Function

Marker Functions are enhancements to the basic Marker functionality of the instrument, which allow you to perform mathematical calculations on trace and marker data and report the results of these calculations in place of the normal marker result.

Key Path	Front-panel key
Instrument S/W Revision	Prior to A.02.00

Select Marker

Displays 12 markers available for selection.

Key Path	Marker Function
Instrument S/W Revision	Prior to A.02.00

Marker Function Type

Sets the marker function type. All interactions and dependencies detailed under the key description are enforced when the remote command is sent.

Remote Command	:CALCulate:LPLot:MARKer [1] 2 3 4 5 6 7 8 9 10 11 12 :FUNction RMSNoise RFM OFF :CALCulate:LPLot:MARKer [1] 2 3 4 5 6 7 8 9 10 11 12 :FUNction?
Example	:CALC:LPL:MARK:FUNC RFM :CALC:LPL:MARK:FUNC?
Key Path	Marker Function
Mode	PN
Preset	=OFF
State Saved	Saved in instrument state.
Range	RMSNoise RFM OFF
Instrument S/W Revision	Prior to A.02.00

RMS Noise (Units)

Sets the units of the marker result of RMS Noise Marker. From SCPI, if the specified marker is not activated for the RMS noise function, then the change does not affect the marker result. It is stored and valid when the RMS noise function is activated.

Remote Command	:CALCulate:LPLot:MARKer [1] 2 3 4 5 6 7 8 9 10 11 12 : RMSNoise:MODE DEGRee RADian JITTer :CALCulate:LPLot:MARKer [1] 2 3 4 5 6 7 8 9 10 11 12 : RMSNoise:MODE?
Example	:CALC:LPL:MARK:RMSN:MODE DEGR :CALC:LPL:MARK:RMSN:MODE?
Key Path	Marker Function, RMS Noise
Mode	PN
Preset	DEGRee
State Saved	Saved in instrument state.
Range	Degree Radian Jitter
Instrument S/W Revision	Prior to A.02.00

Band Adjust

Accesses a menu that allows you to set the span or right and left edges of the selected marker.

Key Path	Marker Function
Instrument S/W Revision	Prior to A.02.00

Band Span

Sets the width of the span for the selected marker.

Remote Command	:CALCulate:LPLot:MARKer [1] 2 3 4 5 6 7 8 9 10 11 12 : BAND:SPAN <freq> :CALCulate:LPLot:MARKer [1] 2 3 4 5 6 7 8 9 10 11 12 : BAND:SPAN?
Dependencies/Couplings	Changing the Band Span necessarily changes the Band Left and Band Right values Band Span is set to 0 when the marker is turned off Band Span is set to 5% of span when any marker function is turned on if and only if it is zero at that time
Example	CALC:LPL:MARK:BAND:SPAN 1MHz CALC:LPL:MARK:BAND:SPAN?

Log Plot Measurement Marker Function

Key Path	Marker Function, Band Adjust
Mode	PN
Preset	5% of Span
State Saved	Saved in instrument state.
Range	Graph Start and Stop Offset Frequencies
Instrument S/W Revision	Prior to A.02.00

Band Left

Sets the left edge frequency or time for the band of the selected marker. The right edge is unaffected.

Remote Command	<code>:CALCulate:LPLot:MARKer [1] 2 3 4 5 6 7 8 9 10 11 12 : BAND:LEFT <freq></code> <code>:CALCulate:LPLot:MARKer [1] 2 3 4 5 6 7 8 9 10 11 12 : BAND:LEFT?</code>
-----------------------	--

Dependencies/Couplings	Changing the Band Left necessarily changes the Band Span value Band Span is set to 0 when the marker is turned off so that means Band Left is set to the center value at this time Band Span is set to 5% of span when any marker function is turned on if and only if it is zero at that time
------------------------	--

Example	<code>CALC:LPL:MARK:BAND:LEFT 1MHz</code> <code>CALC:LPL:MARK:BAND:LEFT?</code>
---------	--

Key Path	Marker Function, Band Adjust
Mode	PN
Preset	5% of Span
State Saved	Saved in instrument state.
Range	Graph Start and Stop Offset Frequencies
Instrument S/W Revision	Prior to A.02.00

Band/Interval Right

Sets the right edge frequency or time for the band of the selected marker. The left edge is unaffected.

Remote Command	<code>:CALCulate:LPLot:MARKer [1] 2 3 4 5 6 7 8 9 10 11 12 : BAND:RIGHT <freq></code> <code>:CALCulate:LPLot:MARKer [1] 2 3 4 5 6 7 8 9 10 11 12 : BAND:RIGHT?</code>
-----------------------	--

Dependencies/Couplings	Changing the Band Right necessarily changes the Band Span value Band Span is set to 0 when the marker is turned off so that means Band Right is set to the center value at this time Band Span is set to 5% of span when any marker function is turned on if and only if it is zero at that time
Example	CALC:LPL:MARK:BAND:RIGH 1MHz CALC:LPL:MARK:BAND:RIGH?
Key Path	Marker Function, Band Adjust
Mode	PN
Preset	5% of Span
State Saved	Saved in instrument state.
Range	Graph Start and Stop Offset Frequencies
Instrument S/W Revision	Prior to A.02.00

Marker To

There is no Marker To functionality supported in this measurement. The front-panel key displays a blank menu when pressed.

Key Path	Front-panel key
Instrument S/W Revision	Prior to A.02.00

Meas

See “[Meas](#)” on page 535 in the section "Common Measurement Functions" for more information.

Meas Setup

Provides a menu of keys allowing you to select Phase Noise measurement parameters.

Key Path	Front-panel key
Instrument S/W Revision	Prior to A.02.00

Avg Number

Allows you to specify the number of measurements made when calculating the average result, or turn averaging on or off.

Remote Command	<code>[:SENSe] :LPLot :AVERage :COUNT <integer></code>
	<code>[:SENSe] :LPLot :AVERage :COUNT?</code>
	<code>[:SENSe] :LPLot :AVERage [:STATe] OFF ON 0 1</code>
	<code>[:SENSe] :LPLot :AVERage [:STATe] ?</code>

Example	<code>:LPL:AVER:COUN 10</code>
	<code>:LPL:AVER:COUN?</code>
	<code>:LPL:AVER ON</code>
	<code>:LPL:AVER?</code>

Key Path	Meas Setup
Mode	PN
Preset	10
	OFF
State Saved	Saved in instrument state.
Min	1
Max	1000
Instrument S/W Revision	Prior to A.02.00

Avg Mode

Allows you to select the type of termination control used for the averaging function. This determines the averaging action after the specified number of data acquisitions (average count) is reached.

When set to Exponential (Exp) the measurement averaging continues using the specified number of averages to compute each exponentially-weighted averaged value. The average is displayed at the end of each sweep.

When set to Repeat, the measurement resets the average counter each time the specified number of averages is reached.

Remote Command	[:SENSe] :LPLot :AVERage:TCONtrol EXPonential REPeat [:SENSe] :LPLot :AVERage:TCONtrol?
Example	LPL:AVER:TCON REP LPL:AVER:TCON?
Key Path	Meas Setup
Mode	PN
Preset	REPeat
State Saved	Saved in instrument state.
Instrument S/W Revision	Prior to A.02.00

Meas Type

This parameter determines whether to measure the Phase Noise of a signal, or the DANL Floor of the analyzer. Phase Noise is the default, and this is the intended use of the measurement, however it can be useful to measure the DANL Floor of the analyzer and compare this with the Phase Noise. This can be achieved by measuring the DANL Floor, and storing it in the reference trace using the softkeys under the display menu.

In DANL Floor mode, the analyzer measures the noise level by maximizing the attenuation. It is accurate enough for most purposes, but removing the input signal from the analyzer before measuring the noise level can be more accurate when the signal level is high.

When measuring the phase noise of a signal, some of the measured phase noise is due to thermal noise generated by the analyzer itself. By measuring the analyzer's internal noise, it can be compensated for, thus giving more accurate results.

Remote Command	[:SENSe] :LPLot :METHod DANL PN [:SENSe] :LPLot :METHod?
Example	:LPL:METH PN :LPL:METH?
Key Path	Meas Setup
Mode	PN
Preset	PN
State Saved	Saved in instrument state.
Range	Phase Noise DANL Floor
Instrument S/W Revision	Prior to A.02.00

Smoothing

Changes the amount of smoothing that is done after the measurement is complete. The smoothing function is much faster than filtering. However, it may cause errors if the noise changes rapidly with frequency, or if there are discrete signals present.

Remote Command	<code>[:SENSE] :LPLot :SMOoth <real></code> <code>[:SENSE] :LPLot :SMOoth?</code>
Restriction and Notes	Changing the Smooth Trace parameter forces the smoothed trace to be recalculated based upon the raw trace – and in turn this forces all results to be recalculated. There is no need to perform a full restart.
Example	<code>:LPL:SMO 4</code> <code>:LPL:SMO?</code>
Key Path	Meas Setup
Mode	PN
Preset	4
State Saved	Saved in instrument state.
Min	0
Max	16
Instrument S/W Revision	Prior to A.02.00

Decade Table

This allows you to toggle the decade table display between On and Off.

The decade table shows the measured values for each plot at every point where the trace(s) cross(es) a decade line on the display.

Remote Command	<code>:CALCulate:LPLot:DECade:TABLE [:STATE] OFF ON 0 1</code> <code>:CALCulate:LPLot:DECade:TABLE [:STATE] ?</code>
Example	<code>:CALC:LPL:DEC:TABL ON</code> <code>:CALC:LPL:DEC:TABL?</code>
Key Path	Meas Setup
Mode	PN
Preset	OFF
State Saved	Saved in instrument state.
Range	On Off
Instrument S/W Revision	Prior to A.02.00

Cancellation

This allows you to toggle the phase noise cancellation feature between On and Off

The cancellation feature allows a previously made measurement of the instrument's DANL noise floor to be automatically subtracted from the current measurement. The DANL of the instrument must be measured and stored in a reference trace before the cancellation feature can be used.

Remote Command	<code>[:SENSe] :LPLot :CANCellation [:STATe] OFF ON 0 1</code> <code>[:SENSe] :LPLot :CANCellation [:STATe] ?</code>
Restriction and Notes	Cancellation can only be turned on if the reference trace contains data.
Example	<code>:LPL:CANC ON</code> <code>:LPL:CANC?</code>
Key Path	Meas Setup, Cancellation
Mode	PN
Preset	OFF
State Saved	Saved in instrument state.
Range	On Off
Instrument S/W Revision	Prior to A.02.00

Ref Trace

Lets you change the trace that is used as a reference DANL floor trace for the cancellation feature. The trace must be in View mode, and contain a valid trace that covers the same frequency range as that being measured.

Remote Command	<code>[:SENSe] :LPLot :CANCellation :TRACe <integer></code> <code>[:SENSe] :LPLot :CANCellation :TRACe?</code>
Example	<code>:LPL:CANC:TRAC 3</code> <code>:LPL:CANC:TRAC?</code>
Key Path	Meas Setup, Cancellation
Mode	PN
Preset	3
State Saved	Saved in instrument state.
Min	1
Max	3
Instrument S/W Revision	Prior to A.02.00

Threshold Δ

This value determines the minimum delta between the reference and pre-cancellation traces that must exist before any cancellation is performed. The delta is evaluated on a tracepoint per tracepoint basis.

Remote Command	<code>[[:SENSE]:LPLot:CANCellation:DELTA <rel_ampl></code> <code>[[:SENSE]:LPLot:CANCellation:DELTA?</code>
Example	<code>:LPL:CANC:DELT 0.01</code> <code>:LPL:CANC:DELT?</code>
Key Path	Meas Setup, Cancellation
Mode	PN
Preset	0.01 dB
State Saved	Saved in instrument state.
Min	0.001 dB
Max	5 dB
Instrument S/W Revision	Prior to A.02.00

Advanced

Accesses advanced features. These features are recommended for use only by advanced users.

Key Path	Meas Setup
Instrument S/W Revision	Prior to A.02.00

AM Rejection

Allows you to enable or disable the AM Rejection functionality.

AM component in measured signals can be rejected with enabling this functionality. The analyzer normalizes each I and Q points with the length of its IQ vector. Thus, reject the amplitude variance caused by the AM component.

AM Rejection is only available in the area where offset frequency is below 1MHz.

Remote Command	<code>[[:SENSE]:LPLot:AMRejection ON OFF 1 0</code> <code>[[:SENSE]:LPLot:AMRejection?</code>
Example	<code>LPL:AMR ON</code> <code>LPL:AMR?</code>
Key Path	Meas Setup, Advanced
Mode	PN
Preset	On

State Saved	Saved in instrument state.
Range	On Off
Instrument S/W Revision	Prior to A.02.00

Overdrive

Allows you to enable or disable the Overdrive functionality.

Overdrive is only available in the portion of the measurement where offset frequency is greater than 1MHz.

Remote Command	[:SENSe] :LPLot :ODrive ON OFF 1 0 [:SENSe] :LPLot :ODrive?
Example	LPL:ODR ON LPL:ODR?
Key Path	Meas Setup, Advanced
Mode	PN
Preset	OFF
State Saved	Saved in instrument state.
Range	On Off
Instrument S/W Revision	Prior to A.02.00

Meas Preset

Restores all measurement parameters to their default values.

Remote Command	:CONFigure:LPLot
Dependencies/Couplings	Selecting Meas Preset restores all measurement parameters to their default values.
Example	:CONF:LPL
Key Path	Meas Setup
Mode	PN
Instrument S/W Revision	Prior to A.02.00

Mode

See “[Mode](#)” on page 551 in the section "Common Measurement Functions" for more information.

Mode Setup

See [“Mode Setup” on page 565](#) in the section "Common Measurement Functions" for more information.

Peak Search

There is no Peak Search functionality supported in this measurement. The front-panel key displays a blank menu when pressed.

Key Path	Front-panel key
Instrument S/W Revision	Prior to A.02.00

Recall

See [“Recall” on page 569](#) in the section "Common Measurement Functions" for more information.

Restart

See “[Restart](#)” on page 591 in the section "Common Measurement Functions" for more information.

Save

See [“Save” on page 593](#) in the section "Common Measurement Functions" for more information.

Single

See “[Single \(Single Measurement/Sweep\)](#)” on page 619 in the section "Common Measurement Functions" for more information.

Source

See “[Source](#)” on page 621 in the section "Common Measurement Functions" for more information.

SPAN X Scale

Accesses a menu of functions that enable you to control the horizontal scale and Span functions of the instrument. These settings apply only to the Log Plot measurement.

Key Path	Front-panel key
Instrument S/W Revision	Prior to A.02.00

Start Offset

Determines the start frequency offset for the log plot graph. This is relative to the carrier frequency, and refers to the upper sideband only.

Remote Command	<code>[:SENSE] :LPLot:FREQuency:OFFSet:STARt <freq></code> <code>[:SENSE] :LPLot:FREQuency:OFFSet:STARt?</code>
Dependencies/Couplings	Dependent upon “X Scale, Stop Offset” Adjusts “X Scale, Stop Offset” to preserve integer number of decades
Restriction and Notes	Related to Stop Offset in that the values must be an integer number of decades apart. Setting this value may modify the Stop Offset parameter to preserve this condition.
Example	<code>:LPL:FREQ:OFFS:STAR 100</code> <code>:LPL:FREQ:OFFS:STAR?</code>
Key Path	X Scale, Start Offset
Mode	PN
Preset	100 Hz
State Saved	Saved in instrument state.
Min	3Hz
Max	Hardware Dependent: Opt503 = 3.699999995 GHz Opt508 = 8.499999995 GHz Opt513 = 13.799999995 GHz Opt526 = 26.999999995 GHz
Instrument S/W Revision	Prior to A.02.00

Stop Offset

Determines the stop frequency offset for the log plot graph. This is relative to the carrier frequency, and refers to the upper sideband only.

Remote Command	[:SENSe] :LPLot :FREQuency:OFFSet :STOP <freq> [:SENSe] :LPLot :FREQuency:OFFSet :STOP?
Dependencies/Couplings	Dependent upon “X Scale, Start Offset” Adjusts “X Scale, Start Offset” to preserve integer number of decades
Restriction and Notes	Related to Start Offset in that the values must be an integer number of decades apart. Setting this value may modify the Start Offset parameter to preserve this condition.
Example	:LPL:FREQ:OFFS:STOP 1000000 :LPL:FREQ:OFFS:STOP?
Key Path	X Scale, Stop Offset
Mode	PN
Preset	1 MHz
State Saved	Saved in instrument state.
Min	100Hz
Max	Hardware Dependent: Opt503 = 3.699999995 GHz Opt508 = 8.499999995 GHz Opt513 = 13.799999995 GHz Opt526 = 26.999999995 GHz
Instrument S/W Revision	Prior to A.02.00

Sweep/Control

Accesses a menu that enables you to pause and restart the measurement.

Key Path	Front-panel key
Instrument S/W Revision	Prior to A.02.00

Trace/Detector

Provides a menu of keys allowing you to select Phase Noise trace parameters, including Copying and Trading selected traces.

Key Path	Front-panel key
Instrument S/W Revision	Prior to A.02.00

Select Trace

Select the active trace for setting trace type from soft keys. When Blank is selected, trace disappears.

Key Path	Trace/Detector
Mode	PN
Instrument S/W Revision	Prior to A.02.00

Trace Type

Set the type of selected trace.

Remote Command	:TRACe [1] 2 3 :LPLot :TYPE RAW SMOothed VIEW BLANk :TRACe [1] 2 3 :LPLot :TYPE?
Remote Command Notes	You must be in the Phase Noise mode to use this command. Use INSTRument:SElect to set the mode.
Example	:TRAC:LPL:TYPE RAW :TRAC:LPL:TYPE?
Key Path	Trace/Detector
Mode	PN
Preset	RAW SMO BLAN
State Saved	Saved in instrument state.
Range	Raw Smoothed Reference(View) Blank
Instrument S/W Revision	Prior to A.02.00

Detector

This parameter is read only and always set to average detector.

Remote Command	[:SENSe] :LPLot :DETector [:FUNction] ?
-----------------------	---

Log Plot Measurement Trace/Detector

Restriction and Notes	Read Only
Example	:LPL:DET?
Mode	PN
Preset	AVERage
Range	AVERage
Instrument S/W Revision	Prior to A.02.00

Copy/Exchange

Allows you to copy or exchange traces from one trace to another.

Key Path	Trace/Detector
Instrument S/W Revision	Prior to A.02.00

From Trace

Specified the source trace for Copy / Exchange Trace.

Key Path	Trace/Detector, CopyExchange
Mode	PN
Preset	1
State Saved	Saved in instrument state.
Min	1
Max	3
Instrument S/W Revision	Prior to A.02.00

To Trace

Specified the destination trace for Copy / Exchange Trace.

Key Path	Trace/Detector, Copy/Exchange
Mode	PN
Preset	2
State Saved	Saved in instrument state.
Min	1
Max	3
Instrument S/W Revision	Prior to A.02.00

Copy Now

Copies the content from the Source Trace into the Destination trace and places the destination trace mode into View

Remote Command	:TRACe:LPLot:COPIY TRACE1 TRACE2 TRACE3 , TRACE1 TRACE2 TRACE3
Dependencies/Couplings	Sets the trace mode of the destination trace into View
Example	:TRAC:LPL:COPIY TRACE1,TRACE2
Key Path	Trace/Detector, Copy/Exchange
Mode	PN
Instrument S/W Revision	Prior to A.02.00

Exchange Now

Swaps the content of the Source Trace into the Destination trace and places the source and destination trace modes into View.

Remote Command	:TRACe:LPLot:EXCHange TRACE1 TRACE2 TRACE3 , TRACE1 TRACE2 TRACE3
Dependencies/Couplings	Sets the trace mode of the source and destination trace into View
Example	:TRAC:LPL:EXCH TRACE1,TRACE2
Key Path	Trace/Detector, Copy/Exchange
Mode	PN
Instrument S/W Revision	Prior to A.02.00

Trigger

Selects the trigger source and trigger setup functionality.

See [“Trigger” on page 641](#) in the section "Common Measurement Functions" for information about all keys in this menu.

Key Path	Front-panel key
Instrument S/W Revision	Prior to A.02.00

View/Display

Accesses a menu of functions that enable you to set the display parameters.

Key Path	Front-panel key
Instrument S/W Revision	A.01.60 or later

Display

Accesses a menu of functions that enable you to set the display parameters.

See “[“Display” on page 697](#)” in the section “Common Measurement Functions” for more information.

Key Path	Front-panel key
Instrument S/W Revision	Prior to A.02.00

Log Plot Measurement
View/Display

The waveform measurement is a generic measurement for viewing the input signal waveforms in the time domain. This measurement represents how the instrument performs the zero span functionality found in traditional spectrum analyzers. For more details, see [“Waveform Measurement Description” on page 384](#) below.

This topic contains the following sections:

[“Measurement Commands for Waveform” on page 383](#)

[“Remote Command Results for Waveform Measurement” on page 383](#)

Measurement Commands for Waveform

The general functionality of CONFigure, INITiate, FETCh, MEASure, and READ are described at this section.

```
:CONFigure:WAVeform
```

```
:CONFigure:WAVeform:NDEFault
```

```
:INITiate:WAVeform
```

```
:FETCh:WAVeform [n]
```

```
:MEASure:WAVeform [n]
```

```
:READ:WAVeform [n]
```

For more measurement related commands, see the SENSE subsystem, and the section [“Remote Measurement Functions” on page 535](#).

Remote Command Results for Waveform Measurement

The following table denotes the returned results from the FETCh|MEASure|READ commands:

n	Results Returned
0	Returns unprocessed I/Q trace data, as a series of trace point values, in volts. The I values are listed first in each pair, using the 0 through even-indexed values. The Q values are the odd-indexed values.
1	Returns the following scalar results: <ol style="list-style-type: none"> 1. Sample Time is a floating point number representing the time between samples when using the trace queries (n=0, 2, and so forth). 2. Mean Power is the mean power (in dBm). This is the power across the entire trace. If averaging is on, the power is for the latest acquisition. 3. Mean Power Averaged is the power (in dBm) for N averages, if averaging is on. This is the power across the entire trace. If averaging is on, the power is for the latest acquisition. If averaging is off, the value of the mean power averaged is the same as the value of the mean power.

n	Results Returned
1 (Cont.)	<ol style="list-style-type: none">4. Number of samples is the number of data points in the captured signal. This number is useful when performing a query on the signal (i.e. when n=0,2,etc.).5. Peak-to-mean ratio has units of dB. This is the ratio of the maximum signal level to the mean power. Valid values are only obtained with averaging turned off. If averaging is on, the peak-to-mean ratio is calculated using the highest peak value, rather than the displayed average peak value.6. Maximum value is the maximum of the most recently acquired data (in dBm).7. Minimum value is the minimum of the most recently acquired data (in dBm).
2	Returns trace point values of the entire captured signal envelope trace data. These data points are floating point numbers representing the power of the signal (in dBm). There are N data points, where N is the number of samples. The period between the samples is defined by the sample time.

Waveform Measurement Description

Also available under basic Waveform measurement is an I/Q window, which shows the I and Q signal waveforms in parameters of voltage versus time to disclose the voltages which comprise the complex modulated waveform of a digital signal.

The waveform measurement can also be used to perform general purpose power measurements to a high degree of accuracy.

Key Path	Front-panel key
Instrument S/W Revision	Prior to A.02.00

AMPTD Y Scale

Accesses a menu of functions that enable you to set the vertical scale parameters.

Key Path	Front-panel key
Instrument S/W Revision	Prior to A.02.00

Ref Value

Sets the absolute power reference value. However, since the Auto Scaling is defaulted to On, this value is automatically determined by the measurement result. When you set a value manually, Auto Scaling automatically changes to Off.

Ref Value (RF Envelope View)

Sets the Y Scale reference value (in dBm) when the RF Envelope View is active. By default, the measurement determines the reference value with Auto Scaling. Entering a reference value manually turns Auto Scaling off.

Key Path	AMPTD Y Scale
Mode	BASIC, PN, WCDMA, C2K, GSM, WIMAX OFDMA, TD-SCDMA, 1xEV-DO, DVB-T/H, DTMB
Remote Command	:DISPlay:WAVEform:VIEW[1]:WINDow[1]:TRACe:Y[:SCALE]:RLEVel <ampl> :DISPlay:WAVEform:VIEW[1]:WINDow[1]:TRACe:Y[:SCALE]:RLEVel?
Example	DISP:WAV:VIEW:WIND:TRAC:Y:RLEV -50 dBm DISP:WAV:VIEW:WIND:TRAC:Y:RLEV?
Notes	You must be in the mode that includes Waveform measurement to use this command. Use INSTRument:SElect to set the mode.
Dependencies/Couplings	When the Auto Scaling is On, this value is automatically determined by the measurement result. When you set a value manually, Auto Scaling automatically changes to Off.
Preset	10.00 dBm
State Saved	Saved in instrument state.
Range	-250.00 dBm to 250.00 dBm
Instrument S/W Revision	Prior to A.02.00

Waveform Measurement AMPTD Y Scale

Ref Value (I/Q Waveform View)

Sets the Y Scale reference value (in volts) when the I/Q Waveform View is active. By default, the measurement determines the reference value with Auto Scaling. Entering a reference value manually turns Auto Scaling off.

Key Path	AMPTD Y Scale
Mode	BASIC, PN, WCDMA, C2K, GSM, WIMAX OFDMA, TD-SCDMA, 1xEV-DO, DVB-T/H, DTMB
Remote Command	:DISP:WAVEform:VIEW2:WINDow[1]:TRACe:Y[:SCALe]:RLEVel <voltage> :DISP:WAVEform:VIEW2:WINDow[1]:TRACe:Y[:SCALe]:RLEVel?
Example	DISP:WAV:VIEW2:WIND:TRAC:Y:RLEV 25 V DISP:WAV:VIEW2:WIND:TRAC:Y:RLEV?
Notes	You must be in the mode that includes Waveform measurement to use this command. Use INSTRUMENT:SELEct to set the mode.
Dependencies/Couplings	When the Auto Scaling is On, this value is automatically determined by the measurement result. When you set a value manually, Auto Scaling automatically changes to Off.
Preset	0 V
State Saved	Saved in instrument state.
Min	-250 V
Max	250 V
Instrument S/W Revision	Prior to A.02.00

Attenuation

Accesses a menu of functions that enable you to change the attenuation settings. This key has a readback text that describes total attenuator value

This is only available when the selected input is RF.

See AMPTD Y Scale, “Attenuation” on page 443 in the section “Common Measurement Functions” for more information.

Key Path	AMPTD Y Scale
Instrument S/W Revision	Prior to A.02.00

Range

Accesses the Range menu to change baseband I/Q gain settings. This key has a readback text that describes gain range value. Refer to “[Amplitude Y Scale \(AMPTD Y Scale\)](#)” on page 443 in the section “Common Measurement Functions” for more information.

Key Path	AMPTD Y Scale
Instrument S/W Revision	Prior to A.02.00

Scale/Div

Sets the units per division of vertical scale in the logarithmic display. However, since the Auto Scaling is defaulted to On, this value is automatically determined by the measurement result. When you set a value manually, Auto Scaling automatically changes to Off.

Scale/Div (RF Envelope View)

Sets the scale per division for the RF Envelope result waveform (time domain) measurements in the graph window.

Key Path	AMPTD Y Scale
Mode	BASIC, PN, WCDMA, C2K, GSM, WIMAX OFDMA, TD-SCDMA, 1xEV-DO, DVB-T/H, DTMB
Remote Command	:DISPlay:WAVEform:VIEW[1]:WINDow[1]:TRACe:Y[:SCALe]:PDIVision <rel_ampl> :DISPlay:WAVEform:VIEW[1]:WINDow[1]:TRACe:Y[:SCALe]:PDIVision?
Example	DISP:WAV:VIEW:WIND:TRAC:Y:PDIV 5 DISP:WAV:VIEW:WIND:TRAC:Y:PDIV?
Notes	You must be in the mode that includes Waveform measurement to use this command. Use INSTRument:SElect to set the mode.
Dependencies/Couplings	When the Auto Scaling is On, this value is automatically determined by the measurement result. When you set a value manually, Auto Scaling automatically changes to Off.
Preset	10.00 dB
State Saved	Saved in instrument state.
Range	0.10 dB to 20.00 dB
Instrument S/W Revision	Prior to A.02.00

Waveform Measurement

AMPTD Y Scale

Scale/Div (I/Q Waveform View)

Sets the scale per division for the I/ Q signal waveform graph.

Key Path	AMPTD Y Scale
Mode	BASIC, PN, WCDMA, C2K, GSM, WIMAX OFDMA, TD-SCDMA, 1xEV-DO, DVB-T/H, DTMB
Remote Command	:DISPlay:WAVEform:VIEW2:WINDow[1]:TRACe:Y[:SCALE]:PDIVision <voltage> :DISPlay:WAVEform:VIEW2:WINDow[1]:TRACe:Y[:SCALE]:PDIVision?
Example	DISP:WAV:VIEW2:WIND:TRAC:Y:PDIV 25mV DISP:WAV:VIEW2:WIND:TRAC:Y:PDIV?
Notes	You must be in the mode that includes Waveform measurement to use this command. Use INSTRument:SElect to set the mode.
Dependencies/Couplings	When the Auto Scaling is On, this value is automatically determined by the measurement result. When you set a value manually, Auto Scaling automatically changes to Off.
Preset	100.0 mV
State Saved	Saved in instrument state.
Min	1.0 nV
Max	20 V
Instrument S/W Revision	Prior to A.02.00

Presel Center

When this key is pressed, the centering of the preselector filter is adjusted to optimize the amplitude accuracy at the frequency of the selected marker.

See “[Presel Center](#)” on page 455 under AMPTD Y Scale in the section "Common Measurement Functions" for more information.

This key is only available when the selected input is RF.

Key Path	AMPTD/Y Scale
Instrument S/W Revision	Prior to A.02.00

Presel Adjust

Allows you to manually adjust the preselector filter frequency to optimize its response to the signal of interest. This function is only available when Presel Center is available.

See “[Preselector Adjust](#)” on page 456 under AMPTD Y Scale in the section “Common Measurement Functions” for more information.

This key is only available when the selected input is RF.

Key Path	AMPTD/Y Scale
Instrument S/W Revision	Prior to A.02.00

Internal Preamp

Accesses a menu of functions that enable you to control the internal preamplifiers.

See AMPTD Y Scale, “[Internal Preamp](#)” on page 458 in the section “Common Measurement Functions” for more information.

This key is only available when the selected input is RF.

Key Path	AMPTD Y Scale
Instrument S/W Revision	Prior to A.02.00

Ref Position

Positions the reference level at the top, center or bottom of the Y Scale display. Changing the reference position does not change the reference level value.

Ref Position (RF Envelope View)

Positions the reference level at the top, center or bottom of the Y Scale display. Changing the reference position does not change the reference level value.

Key Path	AMPTD Y Scale
Mode	BASIC, PN, WCDMA, C2K, GSM, WIMAX OFDMA, TD-SCDMA, 1xEV-DO, DVB-T/H, DTMB
Remote Command	:DISPlay:WAVEform:VIEW[1]:WINDow[1]:TRACe:Y[:SCALE]:RPOSition TOP CENTer BOTTom :DISPlay:WAVEform:VIEW[1]:WINDow[1]:TRACe:Y[:SCALE]:RPOSition?
Example	DISP:WAV:VIEW:WIND:TRAC:Y:RPOS CENT DISP:WAV:VIEW:WIND:TRAC:Y:RPOS?
Notes	You must be in the mode that includes Waveform measurement to use this command. Use INSTRument:SElect to set the mode.

Waveform Measurement AMPTD Y Scale

Preset	TOP
State Saved	Saved in instrument state.
Range	Top Ctr Bot
Instrument S/W Revision	Prior to A.02.00

Ref Position (I/Q Waveform View)

Positions the reference level at the top, center or bottom of the Y Scale display. Changing the reference position does not change the reference level value.

Key Path	AMPTD Y Scale
Mode	BASIC, PN, WCDMA, C2K, GSM, WIMAX OFDMA, TD-SCDMA, 1xEV-DO, DVB-T/H, DTMB
Remote Command	:DISPlay:WAVeform:VIEW2:WINDow[1]:TRACe:Y[:SCALe]:RPOSition TOP CENTer BOTTom :DISPlay:WAVeform:VIEW2:WINDow[1]:TRACe:Y[:SCALe]:RPOSition?
Example	DISP:WAV:VIEW2:WIND:TRAC:Y:RPOS CENT DISP:WAV:VIEW2:WIND:TRAC:Y:RPOS?
Notes	You must be in the mode that includes Waveform measurement to use this command. Use INSTRument:SElect to set the mode.
Preset	CENT
State Saved	Saved in instrument state.
Range	Top Ctr Bot
Instrument S/W Revision	Prior to A.02.00

Auto Scaling

Toggles the Auto Scaling function between On and Off. When the **Restart** front panel key is pressed, this function automatically determines the scale per division and reference values based on the measurement results.

Key Path	AMPTD Y Scale
Mode	BASIC, PN, WCDMA, C2K, GSM, WIMAX OFDMA, TD-SCDMA, 1xEV-DO, DVB-T/H, DTMB
Remote Command	:DISPlay:WAVeform:VIEW[1] 2:WINDow[1]:TRACe:Y[:SCALe]:COUPlE 0 1 OFF ON :DISPlay:WAVeform:VIEW[1] 2:WINDow[1]:TRACe:Y[:SCALe]:COUPlE?

Example	DISP:WAV:VIEW:WIND:TRAC:Y:COUP OFF DISP:WAV:VIEW:WIND:TRAC:Y:COUP?
Notes	You must be in the mode that includes Waveform measurement to use this command. Use INSTRUMENT:SELEct to set the mode.
Dependencies/Couplings	When Auto Scaling is On, upon pressing the Restart front-panel key, this function automatically switches the scale per division and reference values into the defaults. When the user sets a value to either Scale/Div or Ref Value manually, Auto Scaling automatically changes to Off.
Preset	OFF
State Saved	Saved in instrument state.
Range	On Off
Instrument S/W Revision	Prior to A.02.00

Auto Couple

See “**AUTO COUPLE**” on page 461 in the section "Common Measurement Functions" for more information.

BW

Accesses a menu that enables you to control the information bandwidth functions of the instrument. You can also select the filter type for the measurement.

Key Path	Front-panel key
Instrument S/W Revision	Prior to A.02.00

Info BW

Enables you to set the information bandwidth (Info BW) of the analyzer.

Key Path	BW
Mode	BASIC, PN, WCDMA, C2K, GSM, WIMAX OFDMA, TD-SCDMA, 1xEV-DO, DVB-T/H, DTMB
Remote Command	[:SENSE] :WAVEform:BANDwidth[:RESolution] <freq> [:SENSE] :WAVEform:BANDwidth[:RESolution] ?
Example	WAV:BAND 1kHz WAV:BAND?
Notes	You must be in the mode that includes Waveform measurement to use this command. Use INSTRUMENT:SElect to set the mode.
Preset	All except GSM/EDGE: 100 kHz GSM/EDGE: 510kHz TDSCDMA: 1.3MHZ 1xEVDO: 1.3MHz DVB-T/H: 8.0MHZ DTMB: 8.0MHz
State Saved	Saved in instrument state.
Min	10 Hz
Max	Hardware Dependent: RF Input: No Option = 10 MHz Option B25 = 25 MHz I/Q Input: No Option = 10 MHz per channel (20 MHz for I+jQ) Option B25 = 25 MHz per channel (50 MHz for I+jQ) Option S40 = 40 MHz per channel (80 MHz for I+jQ)
Instrument S/W Revision	Prior to A.02.00

IBW Control

Accesses the Filter Type key

Key Path	BW
Instrument S/W Revision	Prior to A.02.00

Filter Type

Selects the type of bandwidth filter that is used. The choices are Gaussian or Flat top.

Key Path	BW, RBW Control
Mode	BASIC, PN, WCDMA, C2K, GSM, WIMAX OFDMA, TD-SCDMA, 1xEV-DO, DVB-T/H, DTMB
Remote Command	[:SENSE] :WAVEform: BANDwidth: SHAPe GAUSSian FLATtop [:SENSE] :WAVEform: BANDwidth: SHAPe?
Example	WAV: BAND: SHAP GAUS WAV: BAND: SHAP?
Notes	You must be in the mode that includes Waveform measurement to use this command. Use INSTRument: SElect to set the mode.
Preset	GAUSSian
State Saved	Saved in instrument state.
Range	Gaussian FlatTop
Instrument S/W Revision	Prior to A.02.00

Gaussian

The table in the section “[Gaussian filters](#)” on page 394 lists all 160 Gaussian filter types.

Gaussian filters

Normal (-3 dB)	-6 dB	Noise	Impulse
1.0 Hz	1.41 Hz	1.06 Hz	1.49 Hz
1.1 Hz	1.55 Hz	1.16 Hz	1.63 Hz
1.2 Hz	1.69 Hz	1.27 Hz	1.77 Hz
1.3 Hz	1.83 Hz	1.37 Hz	1.92 Hz
1.5 Hz	2.11 Hz	1.59 Hz	2.22 Hz
1.6 Hz	2.25 Hz	1.69 Hz	2.37 Hz

Normal (-3 dB)	-6 dB	Noise	Impulse
1.8 Hz	2.53 Hz	1.90 Hz	2.66 Hz
2.0 Hz	2.81 Hz	2.12 Hz	2.96 Hz
2.2 Hz	3.09 Hz	2.33 Hz	3.25 Hz
2.4 Hz	3.38 Hz	2.54 Hz	3.55 Hz
2.7 Hz	3.80 Hz	2.86 Hz	3.99 Hz
3.0 Hz	4.22 Hz	3.17 Hz	4.44 Hz
3.3 Hz	4.64 Hz	3.49 Hz	4.88 Hz
3.6 Hz	5.06 Hz	3.81 Hz	5.32 Hz
3.9 Hz	5.49 Hz	4.12 Hz	5.77 Hz
4.3 Hz	6.05 Hz	4.55 Hz	6.36 Hz
4.7 Hz	6.61 Hz	4.97 Hz	6.95 Hz
5.1 Hz	7.17 Hz	5.39 Hz	7.54 Hz
5.6 Hz	7.87 Hz	5.92 Hz	8.27 Hz
6.2 Hz	8.72 Hz	6.56 Hz	9.17 Hz
6.8 Hz	9.55 Hz	7.18 Hz	10.0 Hz
7.5 Hz	10.5 Hz	7.93 Hz	11.1 Hz
8.2 Hz	11.5 Hz	8.66 Hz	12.1 Hz
9.1 Hz	12.8 Hz	9.64 Hz	13.5 Hz
10 Hz	14.0 Hz	10.6 Hz	14.8 Hz
11 Hz	15.4 Hz	11.6 Hz	16.2 Hz
12 Hz	16.9 Hz	12.7 Hz	17.7 Hz
13 Hz	18.3 Hz	13.7 Hz	19.2 Hz
15 Hz	21.1 Hz	15.9 Hz	22.2 Hz
16 Hz	22.5 Hz	16.9 Hz	23.7 Hz
18 Hz	25.3 Hz	19.1 Hz	26.6 Hz
20 Hz	28.1 Hz	21.1 Hz	29.5 Hz
22 Hz	30.9 Hz	23.2 Hz	32.5 Hz
24 Hz	33.8 Hz	25.4 Hz	35.5 Hz
27 Hz	38.0 Hz	28.6 Hz	40.0 Hz
30 Hz	42.3 Hz	31.8 Hz	44.5 Hz

Waveform Measurement
BW

Normal (-3 dB)	-6 dB	Noise	Impulse
33 Hz	46.3 Hz	34.8 Hz	48.7 Hz
36 Hz	50.7 Hz	38.1 Hz	53.3 Hz
39 Hz	54.9 Hz	41.3 Hz	57.7 Hz
43 Hz	60.5 Hz	45.5 Hz	63.6 Hz
47 Hz	66.1 Hz	49.7 Hz	69.5 Hz
51 Hz	71.7 Hz	53.9 Hz	75.3 Hz
56 Hz	78.9 Hz	59.3 Hz	83.0 Hz
62 Hz	87.3 Hz	65.6 Hz	91.7 Hz
68 Hz	95.5 Hz	71.8 Hz	100 Hz
75 Hz	106 Hz	79.4 Hz	111 Hz
82 Hz	115 Hz	86.8 Hz	121 Hz
91 Hz	128 Hz	96.4 Hz	135 Hz
100 Hz	141 Hz	106 Hz	148 Hz
110 Hz	154 Hz	116 Hz	162 Hz
120 Hz	169 Hz	127 Hz	178 Hz
130 Hz	183 Hz	137 Hz	192 Hz
150 Hz	211 Hz	159 Hz	222 Hz
160 Hz	225 Hz	169 Hz	237 Hz
180 Hz	253 Hz	190 Hz	266 Hz
200 Hz	281 Hz	211 Hz	295 Hz
220 Hz	309 Hz	232 Hz	325 Hz
240 Hz	337 Hz	254 Hz	355 Hz
270 Hz	380 Hz	286 Hz	400 Hz
300 Hz	422 Hz	317 Hz	444 Hz
330 Hz	463 Hz	348 Hz	487 Hz
360 Hz	507 Hz	381 Hz	533 Hz
390 Hz	550 Hz	413 Hz	578 Hz
430 Hz	605 Hz	455 Hz	636 Hz
470 Hz	662 Hz	498 Hz	696 Hz
510 Hz	718 Hz	540 Hz	755 Hz

Normal (-3 dB)	-6 dB	Noise	Impulse
560 Hz	789 Hz	593 Hz	829 Hz
620 Hz	872 Hz	655 Hz	916 Hz
680 Hz	958 Hz	720 Hz	1.01 kHz
750 Hz	1.06 kHz	794 Hz	1.11 kHz
820 Hz	1.15 kHz	866 Hz	1.21 kHz
910 Hz	1.28 kHz	964 Hz	1.35 kHz
1.0 kHz	1.41 kHz	1.06 kHz	1.48 kHz
1.1 kHz	1.55 kHz	1.17 kHz	1.63 kHz
1.2 kHz	1.69 kHz	1.27 kHz	1.78 kHz
1.3 kHz	1.83 kHz	1.38 kHz	1.93 kHz
1.5 kHz	2.11 kHz	1.59 kHz	2.22 kHz
1.6 kHz	2.26 kHz	1.70 kHz	2.37 kHz
1.8 kHz	2.54 kHz	1.91 kHz	2.67 kHz
2.0 kHz	2.82 kHz	2.12 kHz	2.96 kHz
2.2 kHz	3.10 kHz	2.33 kHz	3.26 kHz
2.4 kHz	3.38 kHz	2.54 kHz	3.56 kHz
2.7 kHz	3.80 kHz	2.86 kHz	4.00 kHz
3.0 kHz	4.23 kHz	3.18 kHz	4.44 kHz
3.3 kHz	4.65 kHz	3.49 kHz	4.89 kHz
3.6 kHz	5.06 kHz	3.81 kHz	5.32 kHz
3.9 kHz	5.48 kHz	4.12 kHz	5.76 kHz
4.3 kHz	6.07 kHz	4.56 kHz	6.38 kHz
4.7 kHz	6.62 kHz	4.98 kHz	6.96 kHz
5.1 kHz	7.16 kHz	5.38 kHz	7.53 kHz
5.6 kHz	7.87 kHz	5.92 kHz	8.27 kHz
6.2 kHz	8.74 kHz	6.57 kHz	9.18 kHz
6.8 kHz	9.58 kHz	7.20 kHz	10.1 kHz
7.5 kHz	10.5 kHz	7.92 kHz	11.1 kHz
8.2 kHz	11.5 kHz	8.66 kHz	12.1 kHz
9.1 kHz	12.8 kHz	9.64 kHz	13.5 kHz

Waveform Measurement
BW

Normal (-3 dB)	-6 dB	Noise	Impulse
10 kHz	14.1 kHz	10.6 kHz	14.8 kHz
11 kHz	15.4 kHz	11.6 kHz	16.2 kHz
12 kHz	16.9 kHz	12.7 kHz	17.8 kHz
13 kHz	18.3 kHz	13.7 kHz	19.2 kHz
15 kHz	21.2 kHz	15.9 kHz	22.3 kHz
16 kHz	22.4 kHz	16.8 kHz	23.5 kHz
18 kHz	25.2 kHz	19.0 kHz	26.5 kHz
20 kHz	28.4 kHz	21.3 kHz	29.8 kHz
22 kHz	31.2 kHz	23.4 kHz	32.8 kHz
24 kHz	33.8 kHz	25.4 kHz	35.6 kHz
27 kHz	38.1 kHz	28.7 kHz	40.1 kHz
30 kHz	42.1 kHz	31.7 kHz	44.3 kHz
33 kHz	46.8 kHz	35.2 kHz	49.2 kHz
36 kHz	50.1 kHz	37.7 kHz	52.7 kHz
39 kHz	54.8 kHz	41.2 kHz	57.6 kHz
43 kHz	61.1 kHz	46.0 kHz	64.3 kHz
47 kHz	66.2 kHz	49.8 kHz	69.6 kHz
51 kHz	72.3 kHz	54.3 kHz	76.0 kHz
56 kHz	79.5 kHz	59.8 kHz	83.6 kHz
62 kHz	86.3 kHz	64.9 kHz	90.8 kHz
68 kHz	96.5 kHz	72.6 kHz	101 kHz
75 kHz	106 kHz	79.7 kHz	111 kHz
82 kHz	114 kHz	86.0 kHz	120 kHz
91 kHz	129 kHz	97.3 kHz	136 kHz
100 kHz	140 kHz	105 kHz	147 kHz
110 kHz	154 kHz	116 kHz	162 kHz
120 kHz	169 kHz	127 kHz	178 kHz
130 kHz	182 kHz	137 kHz	192 kHz
150 kHz	210 kHz	158 kHz	221 kHz
160 kHz	223 kHz	168 kHz	235 kHz

Normal (-3 dB)	-6 dB	Noise	Impulse
180 kHz	253 kHz	190 kHz	266 kHz
200 kHz	280 kHz	211 kHz	295 kHz
220 kHz	308 kHz	232 kHz	324 kHz
240 kHz	336 kHz	253 kHz	353 kHz
270 kHz	380 kHz	286 kHz	400 kHz
300 kHz	420 kHz	316 kHz	441 kHz
330 kHz	467 kHz	352 kHz	491 kHz
360 kHz	506 kHz	380 kHz	532 kHz
390 kHz	550 kHz	414 kHz	578 kHz
430 kHz	599 kHz	451 kHz	629 kHz
470 kHz	660 kHz	497 kHz	693 kHz
510 kHz	715 kHz	538 kHz	750 kHz
560 kHz	786 kHz	592 kHz	826 kHz
620 kHz	867 kHz	653 kHz	912 kHz
680 kHz	952 kHz	717 kHz	1.00 MHz
750 kHz	1.05 MHz	791 kHz	1.10 MHz
820 kHz	1.14 MHz	859 kHz	1.19 MHz
910 kHz	1.27 MHz	960 kHz	1.34 MHz
1.0 MHz	1.40 MHz	1.06 MHz	1.47 MHz
1.1 MHz	1.53 MHz	1.15 MHz	1.61 MHz
1.2 MHz	1.66 MHz	1.26 MHz	1.75 MHz
1.3 MHz	1.80 MHz	1.36 MHz	1.89 MHz
1.5 MHz	2.06 MHz	1.56 MHz	2.17 MHz
1.6 MHz	2.19 MHz	1.66 MHz	2.29 MHz
1.8 MHz	2.51 MHz	1.91 MHz	2.63 MHz
2.0 MHz	2.75 MHz	2.10 MHz	2.88 MHz
2.2 MHz	3.00 MHz	2.30 MHz	3.14 MHz
2.4 MHz	3.30 MHz	2.54 MHz	3.45 MHz
2.7 MHz	3.63 MHz	2.81 MHz	3.78 MHz
3.0 MHz	4.09 MHz	3.18 MHz	4.22 MHz

Waveform Measurement
BW

Normal (-3 dB)	-6 dB	Noise	Impulse
4 MHz	5.30 MHz	4.23 MHz	5.30 MHz
5 MHz	5.78 MHz	4.81 MHz	5.41 MHz
6 MHz	6.31 MHz	5.50 MHz	5.82 MHz
8 MHz	8.07 MHz	7.21 MHz	6.90 MHz

Flattop

The table in the section “[Flattop Filters](#)” on page 400 lists all 134 Flattop filter types.

Flattop Filters

3.0 Hz	3.3 Hz	3.6 Hz	3.9 Hz
4.3 Hz	4.7 Hz	5.1 Hz	5.6 Hz
6.2 Hz	6.8 Hz	7.5 Hz	8.2 Hz
9.1 Hz	10 Hz	11 Hz	12 Hz
13 Hz	15 Hz	16 Hz	18 Hz
20 Hz	22 Hz	24 Hz	27 Hz
30 Hz	33 Hz	36 Hz	39 Hz
43 Hz	47 Hz	51 Hz	56 Hz
62 Hz	68 Hz	75 Hz	82 Hz
91 Hz	100 Hz	110 Hz	120 Hz
130 Hz	150 Hz	160 Hz	180 Hz
200 Hz	220 Hz	240 Hz	270 Hz
300 Hz	330 Hz	360 Hz	390 Hz
430 Hz	470 Hz	510 Hz	560 Hz
620 Hz	680 Hz	750 Hz	820 Hz
910 Hz	1.0 kHz	1.1 kHz	1.2 kHz
1.3 kHz	1.5 kHz	1.6 kHz	1.8 kHz
2.0 kHz	2.2 kHz	2.4 kHz	2.7 kHz
3.0 kHz	3.3 kHz	3.6 kHz	3.9 kHz
4.3 kHz	4.7 kHz	5.1 kHz	5.6 kHz
6.2 kHz	6.8 kHz	7.5 kHz	8.2 kHz
9.1 kHz	10 kHz	11 kHz	12 kHz

13 kHz	15 kHz	16 kHz	18 kHz
20 kHz	22 kHz	24 kHz	27 kHz
30 kHz	33 kHz	36 kHz	39 kHz
43 kHz	47 kHz	51 kHz	56 kHz
62 kHz	68 kHz	75 kHz	82 kHz
91 kHz	100 kHz	110 kHz	120 kHz
130 kHz	150 kHz	160 kHz	180 kHz
200 kHz	220 kHz	240 kHz	270 kHz
300 kHz	330 kHz	390 kHz	430 kHz
510 kHz	620 kHz	750 kHz	1.0 MHz
1.5 MHz	3.0 MHz	4 MHz	5 MHz
6 MHz	8 MHz		

Cont

See “[Cont \(Continuous Measurement/Sweep\)](#)” on page 465 in the section "Common Measurement Functions" for more information.

FREQ Channel

See “[FREQ Channel](#)” on page 467 in the section "Common Measurement Functions" for more information.

Input/Output

See “[Input/Output](#)” on page 471 in the section "Common Measurement Functions" for more information.

Marker

Accesses a menu that enables you to select, set up and control the markers for the current measurement.

See “[Marker](#)” on page 529 in the section “Common Measurement Functions” for more information

Key Path	Front-panel key
Instrument S/W Revision	Prior to A.02.00

Select Marker

Displays 12 markers available for selection.

Key Path	Marker
Instrument S/W Revision	Prior to A.02.00

Marker Type

Sets the marker control mode to **Normal**, **Delta**, **Fixed** or **Off**. All interactions and dependencies detailed under the key description are enforced when the remote command is sent. If the selected marker is Off, pressing Marker sets it to Normal and places it at the center of the screen on the trace determined by the **Marker Trace** rules. At the same time, **Marker X Axis Value** appears on the Active Function area.

The default active function is the active function for the currently selected marker control mode. If the current control mode is Off, there is no active function and the active function is turned off.

Key Path	Marker
Mode	BASIC, PN, WCDMA, C2K, GSM, WIMAX OFDMA, TD-SCDMA, 1xEV-DO, DVB-T/H, DTMB
Remote Command	:CALCulate:WAVEform:MARKer [1] 2 3 4 5 6 7 8 9 10 11 12 : MODE POSITION DELTA OFF :CALCulate:WAVEform:MARKer [1] 2 3 4 5 6 7 8 9 10 11 12 : MODE?
Example	CALC:WAV:MARK:MODE OFF CALC:WAV:MARK:MODE?
Notes	If the selected marker is Off, pressing Marker sets it to Normal and places it at the center of the screen on the trace determined by the Marker Trace rules. At the same time, Marker X Axis Value appears on the Active Function area. Default Active Function: the active function for the selected marker’s current control mode. If the current control mode is Off, there is no active function and the active function is turned off. Active Function Display: the marker X axis value entered in the active function area displays the marker value to its full entered precision.

Waveform Measurement Marker

Notes (Cont.)	You must be in the mode that Waveform measurement is included to use this command. Use INSTRument:SElect to set the mode.
Preset	=OFF
Preset	OFF
State Saved	Saved in instrument state.
Range	Normal Delta Off
Instrument S/W Revision	Prior to A.02.00

Marker X Axis Value (Remote Command only)

Sets the marker X Axis value in the current marker X Axis Scale unit. It has no effect if the control mode is **Off**, but is the SCPI equivalent of entering an X value if the control mode is **Normal** or **Delta**.

Mode	BASIC, PN, WCDMA, C2K, GSM, WIMAX OFDMA, TD-SCDMA, 1xEV-DO, DVB-T/H, DTMB
Remote Command	:CALCulate:WAVEform:MARKer [1] 2 3 4 5 6 7 8 9 10 11 12 : X <time> :CALCulate:WAVEform:MARKer [1] 2 3 4 5 6 7 8 9 10 11 12 : X?
Example	CALC:WAV:MARK:X 50 ms CALC:WAV:MARK:X?
Notes	If no suffix is sent, uses the fundamental units for the current marker X Axis Scale. If a suffix is sent that does not match the current marker X Axis Scale unit, an error “Invalid suffix” is generated. If the specified marker is Fixed and a Marker Function is on, error –221 “Settings conflict; cannot adjust Fixed marker while Marker Function is on” is generated. The query returns the marker’s absolute X Axis value if the control mode is Normal , or the offset from the marker’s reference marker if the control mode is Delta . The query is returned in the fundamental units for the current marker X Axis scale: Hz for Frequency and Inverse Time , seconds for Period and Time . If the marker is Off the response is not a number. You must be in the mode that includes Waveform measurement to use this command. Use INSTRument:SElect to set the mode.
Preset	0
Preset	After a preset, all markers are turned OFF, so Marker X Axis Value query returns a not a number (NAN).
State Saved	No
Min	–9.9E+37
Max	9.9E+37
Instrument S/W Revision	Prior to A.02.00

Marker X Axis Position (Remote Command only)

Sets the marker X position in trace points. It has no effect if the control mode is **Off**, but is the SCPI equivalent of entering a value if the control mode is **Normal** or **Delta**. The entered value is immediately translated into the current X Axis Scale units for setting the value of the marker.

Mode	BASIC, PN, WCDMA, C2K, GSM, WIMAX OFDMA, TD-SCDMA, 1xEV-DO, DVB-T/H, DTMB
Remote Command	:CALCulate:WAVEform:MARKer [1] 2 3 4 5 6 7 8 9 10 11 12 : X:POSition <real> :CALCulate:WAVEform:MARKer [1] 2 3 4 5 6 7 8 9 10 11 12 : X:POSition?
Example	CALC:WAV:MARK:X:POS 500 CALC:WAV:MARK:X:POS?
Notes	The query returns the marker's absolute X Axis value in trace points if the control mode is Normal or the offset from the marker's reference marker in trace points if the control mode is Delta . The value is returned as a real number, not an integer, corresponding to the translation from X Axis Scale units to trace points. You must be in the mode that includes Waveform measurement to use this command. Use INSTRument:SElect to set the mode.
Preset	0
Preset	After a preset, all markers are turned OFF, so Marker X Axis Value query returns a not a number (NAN).
State Saved	No
Min	-9.9E+37
Max	9.9E+37
Instrument S/W Revision	Prior to A.02.00

Marker Y Axis Value (Remote Command only)

Queries the marker Y Axis value in the current marker Y Axis unit.

Mode	BASIC, PN, WCDMA, C2K, GSM, WIMAX OFDMA, TD-SCDMA, 1xEV-DO, DVB-T/H, DTMB
Remote Command	:CALCulate:WAVEform:MARKer [1] 2 3 4 5 6 7 8 9 10 11 12 : Y?
Example	CALC:WAV:MARK11:Y?

Waveform Measurement Marker

Notes	<p>When the marker is on, IQ waveform returns I and Q values.</p> <p>Case #1 - Trace RF: returns a single double value.</p> <pre>>:CALC:WAV:MARK1:Y? -2.402406506109E+001</pre> <p>Case #2 - Trace IQ: returns a double array of two values, the first is X, and the second is Y.</p> <pre>>:CALC:WAV:MARK1:Y? -3.006944493834E-003,+9.9870666467354E-004</pre> <p>You must be in the mode that includes Waveform measurement to use this command. Use INSTRUMENT:SELEct to set the mode.</p>
Preset	Result dependant on markers setup and signal source
State Saved	No
Instrument S/W Revision	Prior to A.02.00

Properties

Accesses the marker properties menu.

Key Path	Marker
Instrument S/W Revision	Prior to A.02.00

Select Marker

Displays 12 markers available for selection.

Key Path	Marker
Instrument S/W Revision	Prior to A.02.00

Relative To

Selects the marker that the selected marker is relative to (its reference marker).

Key Path	Marker, Properties
Mode	BASIC, PN, WCDMA, C2K, GSM, WIMAX OFDMA, TD-SCDMA, 1xEV-DO, DVB-T/H, DTMB
Remote Command	<pre>:CALCulate:WAVeform:MARKer [1] 2 3 4 5 6 7 8 9 10 11 12 : REFerence <integer> :CALCulate:WAVeform:MARKer [1] 2 3 4 5 6 7 8 9 10 11 12 : REFerence?</pre>

Example	<pre>CALC:WAV:MARK:REF 8 CALC:WAV:MARK:REF?</pre>
---------	---

Notes	<p>A marker cannot be relative to itself so that choice is grayed out, and if sent from SCPI generates error –221: “Settings conflict; marker cannot be relative to itself.”</p> <p>When queried a single value is returned (the specified marker numbers relative marker).</p> <p>You must be in the mode that Waveform measurement is included to use this command. Use INSTRUMENT:SElect to set the mode.</p>
Preset	2 3 4 5 6 7 8 9 10 11 12 1
State Saved	Saved in instrument state.
Min	1
Max	12
Instrument S/W Revision	Prior to A.02.00

Marker Trace

Assigns the specified marker to the designated trace.

Key Path	Marker
Mode	BASIC, PN, WCDMA, C2K, GSM, WIMAX OFDMA, TD-SCDMA, 1xEV-DO, DVB-T/H, DTMB
Remote Command	<pre>:CALCulate:WAVEform:MARKer [1] 2 3 4 5 6 7 8 9 10 11 12 : TRACe RFENvelope IQ :CALCulate:WAVEform:MARKer [1] 2 3 4 5 6 7 8 9 10 11 12 : TRACe?</pre>
Example	<pre>CALC:WAV:MARK:TRAC RFEN CALC:WAV:MARK:TRAC?</pre>
Notes	<p>Assigns the specified marker to the designated trace.</p> <p>You must be in the mode that includes Waveform measurement to use this command. Use INSTRUMENT:SElect to set the mode.</p>
Preset	RFEN
State Saved	Saved in instrument state.
Range	RF Envelope IQ Waveform
Instrument S/W Revision	Prior to A.02.00

Couple Markers

Toggles the state of the markers to be coupled On or Off. When this function is true (On), moving any marker causes an equal X axis movement of every other marker which is not **Off**. “Equal X axis movement” refers to the difference between each marker’s X Axis value (in the fundamental x-axis units of the trace that marker is on) and the X Axis value of the marker being moved (in the same fundamental x-axis units) are preserved.

Key Path	Marker
Mode	BASIC, PN, WCDMA, C2K, GSM, WIMAX OFDMA, TD-SCDMA, 1xEV-DO, DVB-T/H, DTMB
Remote Command	:CALCulate:WAVeform:MARKer:COUPle[:STATE] ON OFF 1 0 :CALCulate:WAVeform:MARKer:COUPle[:STATE]?
Example	CALC:WAV:MARK:COUP ON CALC:WAV:MARK:COUP ON
Notes	You must be in the mode that includes Waveform measurement to use this command. Use INSTRument:SElect to set the mode.
Preset	OFF
State Saved	Saved in instrument state.
Range	On Off
Instrument S/W Revision	Prior to A.02.00

All Markers Off

Turns off all markers.

Key Path	Marker
Mode	BASIC, PN, WCDMA, C2K, GSM, WIMAX OFDMA, TD-SCDMA, 1xEV-DO, DVB-T/H, DTMB
Remote Command	:CALCulate:WAVeform:MARKer:AOFF
Example	CALC:WAV:MARK:AOFF
Notes	You must be in the mode that includes Waveform measurement to use this command. Use INSTRument:SElect to set the mode.
Instrument S/W Revision	Prior to A.02.00

Marker Function

Accesses a menu of marker functions that perform post-processing operations on markers based on the measurement specifications. Marker functions are distinct from Measurement functions, which automatically perform complex sequences of setup, data acquisition, and display operations in order to measure specified signal characteristics. Marker Functions are specified for each individual marker and may be turned on individually for each marker.

The **Marker Function** menu controls which marker functions are turned on and allows you to adjust the setup parameters for each function. These parameters include the following, but only one parameter can be assigned to a given marker:

- **Marker Noise**
- **Band/Interval Power**
- **Band/Interval Density**
- **Marker Function Off**

Key Path	Front-panel key
Instrument S/W Revision	Prior to A.02.00

Select Marker

Displays 12 markers available for selection.

Key Path	Marker
Instrument S/W Revision	Prior to A.02.00

Marker Function Type

Sets the marker control function type to, Marker Noise, Band/Interval Power, Band Interval Density, or Marker Function Off

Key Path	Marker Function
Mode	BASIC, PN, WCDMA, C2K, GSM, WIMAX OFDMA, TD-SCDMA, 1xEV-DO, DVB-T/H, DTMB
Remote Command	:CALCulate:WAVEform:MARKer[1] 2 3 4 5 6 7 8 9 10 11 12:FUNCTION BPOWER BDENSITY OFF :CALCulate:WAVEform:MARKer[1] 2 3 4 5 6 7 8 9 10 11 12:FUNCTION?
Example	CALC:WAV:MARK:FUNC BPOW CALC:WAV:MARK:FUNC?

Waveform Measurement
Marker Function

Notes	You must be in the mode that includes Waveform measurement to use this command. Use INSTRument:SElect to set the mode.
Preset	OFF
State Saved	Saved in instrument state.
Range	Band/Interval Power Band Interval Density Marker Function Off
Instrument S/W Revision	Prior to A.02.00

Band Adjust

Accesses a menu that enables you to set the frequency span width and the left and right edge, or time values, for the band or interval of the selected marker.

Key Path	Marker Function
Instrument S/W Revision	Prior to A.02.00

Band/Interval Span for Time Domain

Sets the width of the frequency span for the selected marker.

Key Path	Marker Function
Mode	BASIC, PN, WCDMA, C2K, GSM, WIMAX OFDMA, TD-SCDMA, 1xEV-DO, DVB-T/H, DTMB
Remote Command	:CALCulate:WAVEform:MARKer [1] 2 3 4 5 6 7 8 9 10 11 12 : FUNction:BAND:SPAN <time> :CALCulate:WAVEform:MARKer [1] 2 3 4 5 6 7 8 9 10 11 12 : FUNction:BAND:SPAN?
Example	CALC:WAV:MARK:FUNC:BAND:SPAN 20 ms CALC:WAV:MARK:FUNC:BAND:SPAN?
Notes	You must be in the mode that includes Waveform measurement to use this command. Use INSTRument:SElect to set the mode.
Dependencies/Couplings	Changing the Band/Interval Span necessarily changes the Band/Interval Left and Band/Interval Right values
Preset	0
Preset	10% of Meas Time
State Saved	Saved in instrument state.
Min	0
Max	100s
Instrument S/W Revision	Prior to A.02.00

Band/Interval Left for Time Domain

Sets the left edge frequency or time value for the band of the selected marker.

Key Path	Marker Function
Mode	BASIC, PN, WCDMA, C2K, GSM, WIMAX OFDMA, TD-SCDMA, 1xEV-DO, DVB-T/H, DTMB
Remote Command	:CALCulate:WAVEform:MARKer[1] 2 3 4 5 6 7 8 9 10 11 12:FUNCTION:BAND:LEFT <time> :CALCulate:WAVEform:MARKer[1] 2 3 4 5 6 7 8 9 10 11 12:FUNCTION:BAND:LEFT?
Example	CALC:WAV:MARK12:FUNC:BAND:LEFT 1 s CALC:WAV:MARK12:FUNC:BAND:LEFT?
Notes	You must be in the mode that includes Waveform measurement to use this command. Use INSTRument:SElect to set the mode.
Dependencies/Couplings	Changing the Band/Interval Left necessarily changes the Band/Interval Span and Band/Interval Right values
Preset	0
Preset	5% of Meas Time
State Saved	Saved in instrument state.
Min	0
Max	100s
Instrument S/W Revision	Prior to A.02.00

Band/Interval Right for Time Domain

Sets the right edge frequency or time value for the band of the selected marker.

Key Path	Marker Function
Mode	BASIC, PN, WCDMA, C2K, GSM, WIMAX OFDMA, TD-SCDMA, 1xEV-DO, DVB-T/H, DTMB
Remote Command	:CALCulate:WAVEform:MARKer[1] 2 3 4 5 6 7 8 9 10 11 12:FUNCTION:BAND:RIGHT <time> :CALCulate:WAVEform:MARKer[1] 2 3 4 5 6 7 8 9 10 11 12:FUNCTION:BAND:RIGHT?
Example	CALC:WAV:MARK12:FUNC:BAND:RIGHT 1 s CALC:WAV:MARK12:FUNC:BAND:RIGHT?
Notes	You must be in the mode that includes Waveform measurement to use this command. Use INSTRument:SElect to set the mode.

Waveform Measurement
Marker Function

Dependencies/Couplings	Changing the Band/Interval Left necessarily changes the Band/Interval Span and Band/Interval Right values
Preset	0
Preset	5% of Meas Time
State Saved	Saved in instrument state.
Min	0
Max	100s
Instrument S/W Revision	Prior to A.02.00

Marker To

There is no 'Marker To' functionality supported in Waveform measurements. The front-panel key displays a blank menu key when pressed.

Key Path	Front-panel key
Instrument S/W Revision	Prior to A.02.00

Meas

See “[Meas](#)” on page 535 in the section "Common Measurement Functions" for more information.

Meas Setup

Displays the setup menu keys that enable you to control the parameters for the current measurement.

Key Path	Front-panel key
Instrument S/W Revision	Prior to A.02.00

Average/Hold Number

Sets the number of sweeps (average counts) that are averaged. After the specified number of sweeps, the averaging mode (terminal control) setting determines the averaging action.

Key Path	Meas Setup
Mode	BASIC, PN, WCDMA, C2K, GSM, WIMAX OFDMA, TD-SCDMA, 1xEV-DO, DVB-T/H, DTMB
Remote Command	[:SENSe]:WAVeform:AVERage:COUNT <integer> [:SENSe]:WAVeform:AVERage:COUNT? [:SENSe]:WAVeform:AVERage[:STATe] OFF ON 0 1 [:SENSe]:WAVeform:AVERage[:STATe]?
Example	WAV:AVER:COUN 1001 WAV:AVER:COUN? WAV:AVER ON WAV:AVER?
Notes	You must be in the mode that includes Waveform measurement to use this command. Use INSTRument:SELEct to set the mode.
Preset	10 OFF
State Saved	Saved in instrument state.
Min	1
Max	20001
Instrument S/W Revision	Prior to A.02.00

Avg Mode

Enables you to set the averaging mode.

When set to Exponential (Exp) the measurement averaging continues using the specified number of averages to compute each averaged value. The average is displayed at the end of each sweep.

Waveform Measurement Meas Setup

When set to Repeat, the measurement resets the average counter each time the specified number of averages is reached.

Key Path	Meas Setup
Mode	BASIC, PN, WCDMA, C2K, GSM, WIMAX OFDMA, TD-SCDMA, 1xEV-DO, DVB-T/H, DTMB
Remote Command	[:SENSE] :WAVEform:AVERage:TCONtrol EXPonential REPeat [:SENSE] :WAVEform:AVERage:TCONtrol?
Example	WAV:AVER:TCON REP WAV:AVER:TCON?
Notes	You must be in the mode that includes Waveform measurement to use this command. Use INSTRument:SELEct to set the mode.
Preset	EXPonential
State Saved	Saved in instrument state.
Range	Exp Repeat
Instrument S/W Revision	Prior to A.02.00

Avg Type

Selects the type of averaging.

Key Path	Meas Setup
Mode	BASIC, PN, WCDMA, C2K, GSM, WIMAX OFDMA, TD-SCDMA, 1xEV-DO, DVB-T/H, DTMB
Remote Command	[:SENSE] :WAVEform:AVERage:TYPE LOG MAXimum MINimum RMS SCALar [:SENSE] :WAVEform:AVERage:TYPE?
Example	WAV:AVER:TYPE MAX WAV:AVER:TYPE?
Notes	The SCPI selection of MAX and MIN are kept because of BWCC reason, but they are removed from the front panel access because they are not Average. You must be in the mode that includes Waveform measurement to use this command. Use INSTRument:SELEct to set the mode.
Preset	RMS
State Saved	Saved in instrument state.
Range	Pwr Avg(RMS) Log-Pwr Avg(Video) Voltage Avg
Instrument S/W Revision	Prior to A.02.00

Meas Time

Sets how long the measurement is performed. X Scale only changes the representation of the display.

Key Path	Meas Setup
Mode	BASIC, PN, WCDMA, C2K, GSM, WIMAX OFDMA, TD-SCDMA, 1xEV-DO, DVB-T/H, DTMB
Remote Command	[:SENSE] :WAVeform:SWEep:TIME <time> [:SENSE] :WAVeform:SWEep:TIME?
Example	WAV:SWE:TIME 50 ms WAV:SWE:TIME?
Notes	Specifies and returns how long the measurement is performed. It is the time record length of the measurement waveform. The Max time may be reduced when the sample frequency is high due to the memory limitation. You must be in the mode that includes Waveform measurement to use this command. Use INSTRument:SElect to set the mode.
Preset	2.000000 ms
State Saved	Saved in instrument state.
Range	1.000 μ s to 100.00 s
Instrument S/W Revision	Prior to A.02.00

Meas Preset

Restores all the measurement parameters to their default values.

Key Path	Meas Setup
Mode	BASIC, PN, WCDMA, C2K, GSM, WIMAX OFDMA, TD-SCDMA, 1xEV-DO, DVB-T/H, DTMB
Remote Command	:CONFigure:WAVeform
Example	CONF:WAV
Notes	Restore default values of all parameters. You must be in the mode that includes Waveform measurement to use this command. Use INSTRument:SElect to set the mode.
Instrument S/W Revision	Prior to A.02.00

Advanced

Accesses a menu of “advanced” functions that are used for specific applications. These settings should not be changed for most measurements.

Key Path	Meas Setup
Instrument S/W Revision	Prior to A.02.00

ADC Dither

Accesses the ADC Dither control menu.

Key Path	Meas Setup, Advanced
Instrument S/W Revision	Prior to A.02.00

ADC Dither Auto

Sets ADC dithering to automatically select whether dithering is needed.

Key Path	Meas Setup, Advanced, ADC Dither
Mode	BASIC, PN, WCDMA, C2K, GSM, WIMAX OFDMA, TD-SCDMA, 1xEV-DO, DVB-T/H, DTMB
Remote Command	[:SENSe] :WAVeform:ADC:DITHer:AUTO [:STATe] OFF ON 0 1 [:SENSe] :WAVeform:ADC:DITHer:AUTO [:STATe] ?
Example	WAV:ADC:DITH:AUTO ON WAV:ADC:DITH:AUTO?
Notes	The dither function improves linearity for low level signals, at the expense of a higher noise floor. This table is for SCPI definition purpose only. You must be in the mode that includes Waveform measurement to use this command. Use INSTRument:SElect to set the mode.
Preset	OFF
State Saved	Saved in instrument state.
Range	On Off
Instrument S/W Revision	Prior to A.02.00

ADC Dither

Toggles the dither function On and Off. The dither function improves linearity for low level signals, at the expense of a higher noise floor.

The reduced clipping-to-noise ratio results in higher noise, because the clipping level of the ADC relative to the front terminals remains unchanged with the introduction of dither. The enhanced linearity is mostly improved scale fidelity.

With dither on, the third-order distortions are usually invisible for mixer levels below –35 dBm. With dither off, these distortions can be visible, with typical power levels of –110 dBm referred to the mixer. Detection nonlinearity can reach 1 dB for dither off at mixer levels around –70 dBm and lower, while the specified nonlinearity is many times smaller with dither on.

Key Path	Meas Setup, Advanced, ADC Dither
Mode	BASIC, PN, WCDMA, C2K, GSM, WIMAX OFDMA, TD-SCDMA, 1xEV-DO, DVB-T/H, DTMB
Remote Command	[:SENSe] :WAVeform:ADC:DITHer [:STATe] OFF ON 0 1 [:SENSe] :WAVeform:ADC:DITHer [:STATe] ?
Example	WAV:ADC:DITH ON WAV:ADC:DITH?
Notes	The dither function improves linearity for low level signals, at the expense of a higher noise floor. . You must be in the mode that includes Waveform measurement to use this command. Use INSTRument:SElect to set the mode.
Preset	OFF
State Saved	Saved in instrument state.
Range	Auto Man
Instrument S/W Revision	Prior to A.02.00

IF Gain

Sets the IF Gain function to Auto, Low Gain or High Gain. These settings affect sensitivity and IF overloads.

This only applies to the RF input. It does not apply to baseband I/Q input.

Key Path	Meas Setup, Advanced
Instrument S/W Revision	Prior to A.02.00

IF Gain Auto

Activates the auto rules for IF Gain. When Auto is active, the IF Gain is set to High Gain under and of the following conditions:

- The input attenuator is set to 0 dB
- the preamp is turned On and the frequency range is under 3.6 GHz

For other settings, Auto sets the IF Gain to Low Gain.

Key Path	Meas Setup, Advanced, IF Gain
----------	--------------------------------------

Waveform Measurement Meas Setup

Mode	BASIC, PN, WCDMA, C2K, GSM, WIMAX OFDMA, TD-SCDMA, 1xEV-DO, DVB-T/H, DTMB
Remote Command	[:SENSe] :WAVeform:IF:GAIN:AUTO [:STATe] ON OFF 1 0 [:SENSe] :WAVeform:IF:GAIN:AUTO [:STATe] ?
Example	WAV:IF:GAIN:AUTO ON WAV:IF:GAIN:AUTO?
Notes	This only applies to the RF input. It does not apply to baseband I/Q input. You must be in the mode that includes Waveform measurement to use this command. Use INSTRument:SELEct to set the mode.
Preset	ON
State Saved	Saved in instrument state.
Range	On Off
Instrument S/W Revision	Prior to A.02.00

IF Gain State

Selects the range of IF gain.

Key Path	Meas Setup, Advanced, IF Gain
Mode	BASIC, PN, WCDMA, C2K, GSM, WIMAX OFDMA, TD-SCDMA, 1xEV-DO, DVB-T/H, DTMB
Remote Command	[:SENSe] :WAVeform:IF:GAIN [:STATe] AUTOrange LOW HIGH [:SENSe] :WAVeform:IF:GAIN [:STATe] ?
Example	WAV:IF:GAIN HIGH WAV:IF:GAIN?
Notes	This only applies to the RF input and does not apply to baseband I/Q input. You must be in the mode that includes Waveform measurement to use this command. Use INSTRument:SELEct to set the mode.
Preset	AUTO
State Saved	Saved in instrument state.
Range	Autorange (Slower Follows Signals) Low (Best for Large Signals) High (Best Noise Level)
Instrument S/W Revision	Prior to A.02.00

Mode

See “[Mode](#)” on page 551 in the section "Common Measurement Functions" for more information.

Mode Setup

See “[Mode Setup](#)” on page 565 in the section "Common Measurement Functions" for more information.

Peak Search

Places the selected marker on the trace point with the maximum y-axis value for that marker's trace and accesses a menu that enables you to select to do a minimum peak search.

Key Path	Front-panel key
Mode	BASIC, PN, WCDMA, C2K, GSM, WIMAX OFDMA, TD-SCDMA, 1xEV-DO, DVB-T/H, DTMB
Remote Command	:CALCulate:WAVEform:MARKer [1] 2 3 4 5 6 7 8 9 10 11 12 : MAXimum
Example	CALC:WAV:MARK2:MAX
Notes	You must be in the mode that includes Waveform measurement to use this command. Use INSTRument:SElect to set the mode.
Instrument S/W Revision	Prior to A.02.00

Next Peak

Moves the selected marker to the next highest local maximum with a value less than the current marker's.

Key Path	Peak Search
Mode	BASIC
Remote Command	:CALCulate:WAVEform:MARKer [1] 2 3 4 5 6 7 8 9 10 11 12 : MAXimum:NEXT
Example	CALC:WAV:MARK:MAX:NEXT
Notes	You must be in the mode that includes Waveform measurement to use this command. Use INSTRument:SElect to set the mode.
Instrument S/W Revision	Prior to A.02.00

Min Search

Moves the selected marker to the minimum y-axis value on the current trace.

Key Path	Peak Search
Mode	BASIC, PN, WCDMA, C2K, GSM, WIMAX OFDMA, TD-SCDMA, 1xEV-DO, DVB-T/H, DTMB
Remote Command	:CALCulate:WAVEform:MARKer [1] 2 3 4 5 6 7 8 9 10 11 12 : MINimum
Example	CALC:WAV:MARK:MIN

Waveform Measurement
Peak Search

Notes	You must be in the mode that includes Waveform measurement to use this command. Use INSTRument:SElect to set the mode.
Instrument S/W Revision	Prior to A.02.00

Recall

See [“Recall” on page 569](#) in the section "Common Measurement Functions" for more information.

Restart

See “[Restart](#)” on page 591 in the section "Common Measurement Functions" for more information.

Save

See [“Save” on page 593](#) in the section "Common Measurement Functions" for more information.

Single

See “[Single \(Single Measurement/Sweep\)](#)” on page 619 in the section "Common Measurement Functions" for more information.

Source

See “[Source](#)” on page 621 in the section "Common Measurement Functions" for more information.

Span X Scale

Accesses a menu of functions that enable you to set the horizontal scale parameters.

Key Path	Front-panel key
Instrument S/W Revision	Prior to A.02.00

Ref Value

Sets the reference value for time on the horizontal axis. When Auto Scaling is set to On, the displayed plots use a Scale/Div value determined by the analyzer, based on the measurement result.

Key Path	SPAN X Scale
Mode	BASIC, PN, WCDMA, C2K, GSM, WIMAX OFDMA, TD-SCDMA, 1xEV-DO, DVB-T/H, DTMB
Remote Command	:DISPlay:WAVEform:VIEW[1] 2:WINDow[1]:TRACe:X[:SCALe]:RLEVel <time> :DISPlay:WAVEform:VIEW[1] 2:WINDow[1]:TRACe:X[:SCALe]:RLEVel?
Example	DISP:WAV:VIEW:WIND:TRAC:X:RLEV 10 ms DISP:WAV:VIEW:WIND:TRAC:X:RLEV?
Notes	You must be in the mode that includes Waveform measurement to use this command. Use INSTRument:SElect to set the mode.
Dependencies/Couplings	If the Auto Scaling is set to On, this value is automatically determined by the measurement result. When you set this value manually, Auto Scaling automatically changes to Off.
Preset	0.00 s
State Saved	Saved in instrument state.
Min	-1.000 s
Max	10.00 s
Instrument S/W Revision	Prior to A.02.00

Scale/Div

Sets the horizontal scale by changing a time value per division.

Key Path	SPAN X Scale
Mode	BASIC, PN, WCDMA, C2K, GSM, WIMAX OFDMA, TD-SCDMA, 1xEV-DO, DVB-T/H, DTMB

Remote Command	:DISPlay:WAVEform:VIEW[1] 2:WINDow[1] :TRACe:X[:SCALe] : PDIVision <time>
	:DISPlay:WAVEform:VIEW[1] 2:WINDow[1] :TRACe:X[:SCALe] : PDIVision?
Example	DISP:WAV:VIEW:WIND:TRAC:X:PDIV 500 us DISP:WAV:VIEW:WIND:TRAC:X:PDIV?
Notes	You must be in the mode that includes Waveform measurement to use this command. Use INSTRument:SElect to set the mode.
Dependencies/Couplings	If the Auto Scaling is set to On, this value is automatically determined by the measurement result. When you set this value manually, Auto Scaling automatically changes to Off.
Preset	200.0 us
State Saved	Saved in instrument state.
Min	1.000 ns
Max	1.000 s
Instrument S/W Revision	Prior to A.02.00

Ref Position

Sets the reference position for the X axis to Left, Center or Right.

Key Path	SPAN X Scale
Mode	BASIC, PN, WCDMA, C2K, GSM, WIMAX OFDMA, TD-SCDMA, 1xEV-DO, DVB-T/H, DTMB
Remote Command	:DISPlay:WAVEform:VIEW[1] 2:WINDow[1] :TRACe:X[:SCALe] : RPOsition LEFT CENTer RIGHT
	:DISPlay:WAVEform:VIEW[1] 2:WINDow[1] :TRACe:X[:SCALe] : RPOsition?
Example	DISP:WAV:VIEW:WIND:TRAC:X:RPOS LEFT DISP:WAV:VIEW:WIND:TRAC:X:RPOS?
Notes	Allows you to set the reference position to Left, Ctr (center) or Right. You must be in the mode that includes Waveform measurement to use this command. Use INSTRument:SElect to set the mode.
Preset	LEFT
State Saved	Saved in instrument state.
Range	Left Ctr Right
Instrument S/W Revision	Prior to A.02.00

Auto Scaling

Toggles the scale coupling function between On and Off.

Key Path	SPAN X Scale
Mode	BASIC, PN, WCDMA, C2K, GSM, WIMAX OFDMA, TD-SCDMA, 1xEV-DO, DVB-T/H, DTMB
Remote Command	:DISPlay:WAVeform:VIEW[1] 2:WINDow[1]:TRACe:X[:SCALe]:COUPlE 0 1 OFF ON :DISPlay:WAVeform:VIEW[1] 2:WINDow[1]:TRACe:X[:SCALe]:COUPlE?
Example	DISP:WAV:VIEW:WIND:TRAC:X:COUP ON DISP:WAV:VIEW:WIND:TRAC:X:COUP?
Notes	You must be in the mode that includes Waveform measurement to use this command. Use INSTRument:SELEct to set the mode.
Dependencies/Couplings	When Auto Scaling is On and the Restart front-panel key is pressed, this function automatically determines the scale per division and reference values based on the measurement results. When you set a value to either Scale/Div or Ref Value manually, Auto Scaling automatically changes to Off.
Preset	1
State Saved	Saved in instrument state.
Range	On Off
Instrument S/W Revision	Prior to A.02.00

Sweep/Control

Accesses the Sweep menu that allows you to pause and restart the measurement.

Key Path	Front-panel key
Instrument S/W Revision	Prior to A.02.00

Pause and Resume

Pauses a measurement after the current data acquisition is complete. When Paused, the label on the key changes to Resume. Pressing the Resume key resumes the measurement at the point it was at when paused.

See [“Sweep / Control” on page 625](#) in the section "Common Measurement Functions" for more information.

Key Path	Sweep/Control
Instrument S/W Revision	Prior to A.02.00

Trace/Detector

There is no 'Trace/Detector' functionality supported in the Waveform measurement. The front-panel key displays a blank menu key when pressed.

Key Path	Front-panel key
Instrument S/W Revision	Prior to A.02.00

Trigger

Accesses a menu of functions that enable you to select and control the trigger source for the current measurement

See [“Trigger” on page 641](#) in the section "Common Measurement Functions" for information about all keys in this menu.

Key Path	Front-panel key
Instrument S/W Revision	Prior to A.02.00

View/Display

Accesses a menu of functions that enable you to set up and control the display parameters for the current measurement.

This topic contains the following sections:

[“View Selection by name \(SCPI only\)” on page 438](#)

[“View Selection by number \(SCPI only\)” on page 438](#)

View Selection by name (SCPI only)

Selects the results view.

Key Path	View/Display
Mode	BASIC, PN, WCDMA, C2K, GSM, WIMAX OFDMA, TD-SCDMA, 1xEV-DO, DVB-T/H, DTMB
Remote Command	:DISPlay:WAVeform:VIEW[:SElect] RFENvelope IQ :DISPlay:WAVeform:VIEW[:SElect]?
Example	DISP:WAV:VIEW RFEN DISP:WAV:VIEW?
Notes	You must be in the mode that includes Waveform measurement to use this command. Use INSTRument:SElect to set the mode.
Preset	RFENveloper
State Saved	Saved in instrument state.
Range	RF Envelope IQ Waveform
Instrument S/W Revision	Prior to A.02.00

View Selection by number (SCPI only)

Displays the numeric values of the measurement results.

Mode	BASIC, PN, WCDMA, C2K, GSM, WIMAX OFDMA, TD-SCDMA, 1xEV-DO, DVB-T/H, DTMB
Remote Command	:DISPlay:WAVeform:VIEW:NSElect <integer> :DISPlay:WAVeform:VIEW:NSElect?
Example	DISP:WAV:VIEW:NSEL 1 DISP:WAV:VIEW:NSEL?
Notes	You must be in the mode that includes Waveform measurement to use this command. Use INSTRument:SElect to set the mode.

Preset	1
State Saved	Saved in instrument state.
Min	1
Max	2
Instrument S/W Revision	Prior to A.02.00
Key Path	Front-panel key
Instrument S/W Revision	Prior to A.02.00

Display

Accesses a menu of functions that enable you to set the display parameters.

See “Display” on page 697 in the section “Common Measurement Functions” for more information.

Key Path	View/Display
Instrument S/W Revision	Prior to A.02.00

RF Envelope

The view below shows an example of the RF Envelope result for the waveform (time domain) measurements in the graph window. The measured values for the mean power and peak-to-mean power are shown in the text window.

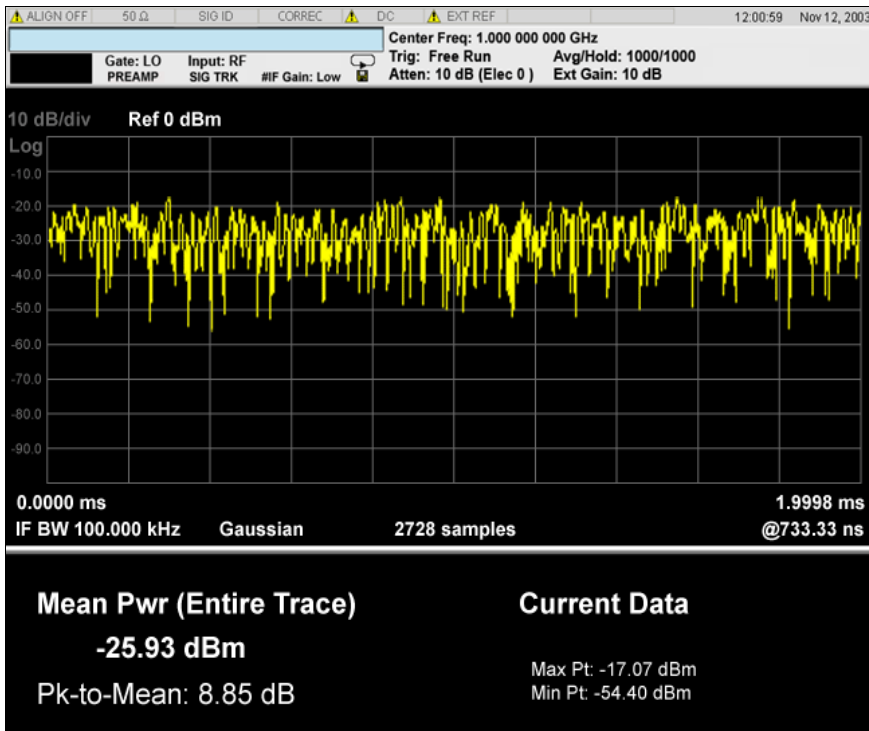

Waveform Measurement
View/Display

Numeric Results

Name	Type	Description	Unit	Format
Mean Pwr	Float64	The mean power (dBm). This is either the power across the entire trace, or the power between markers if the markers are enabled.	dBm	XX.XX dBm
Pk-to-Mean	Float64	This is the ratio of the maximum signal level to the mean power.	dB	XX.XX dB
Max Pt	Float64	The maximum of the most recently acquired data.	dBm	XX.XX dBm
Min Pt	Float64	The minimum of the most recently acquired data.	dBm	XX.XX dBm

Key Path **View/Display**
Instrument S/W Revision Prior to A.02.00

I/Q Waveform

The view below shows the I and Q signal waveforms in parameters of voltage versus time.

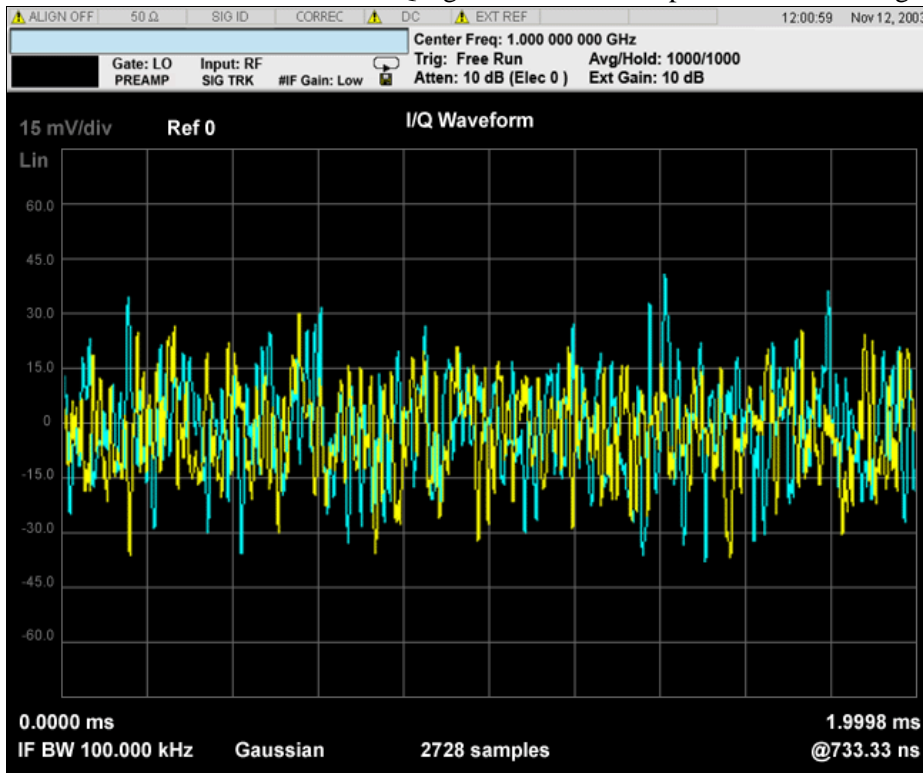

Key Path **View/Display**
Instrument S/W Revision Prior to A.02.00

The key and command descriptions in this section describe functions that operate the same in multiple measurements and/or modes. This section is a library of functions that is referenced by many measurements and modes

To find the exact description and parameters for functions in a specific measurement, always look in the measurement section of this documentation. Pressing the front-panel key or softkey and then pressing the green Help key also provides the correct information.

NOTE

If you want to print the documentation, be sure to select this section and the measurement of interest to ensure having all the information you need. See [“Printing Acrobat Files” on page 69](#) for further instructions about printing.

Amplitude Y Scale (AMPTD Y Scale)

Some Amplitude features are common across multiple Modes and Measurements. These common features are described in this section. See the Measurement description for information on features that are specific to that measurement.

The Amplitude key activates the Amplitude menu and selects Reference Level as the active function.

Key Path	Front-panel key
Instrument S/W Revision	Prior to A.02.00

Attenuation

This menu controls both the electrical and mechanical attenuators and their interactions. All parameters in the Attenuation menus are Meas Global, meaning they are common to all the measurements and are unaffected by Meas Preset.

Dependencies/Couplings	In measurements which support the I/Q inputs, this key is unavailable when I/Q is the selected input, and is replaced by the Range key in that case.
Key Path	AMPTD Y Scale
Readback Line	Contains a summary in [] brackets of the total attenuation from the menu below, which is the current Total (Elec + Mech) attenuation. Note that when in "Pre-Adjust for Min Clip" this value can change at the start of every measurement.
Instrument S/W Revision	Prior to A.02.00

Mech Atten Auto/Man

You can modify the mechanical attenuation applied to the RF input signal path. This value is normally auto coupled to the Ref Level, the Internal Preamp Gain, any External Gain that is entered, and the Max Mixer Level, as described in the table below. However, when the electrical attenuator is enabled, there is no Auto/Man functionality for the mechanical attenuator, and the third line of the key disappears. The Auto/Man state of the key is remembered and restored when the electrical attenuator is once again disabled.

Some measurement applications have functionality that can pre-adjust the input signal for minimum clipping. That is, it attenuates the input so it does not over-drive the analyzer. When this functionality is available, the Auto/Man selection is not available.

Remote Command:	<code>[:SENSE] :POWER [:RF] :ATTenuation <rel_ampl></code>
	<code>[:SENSE] :POWER [:RF] :ATTenuation?</code>
	<code>[:SENSE] :POWER [:RF] :ATTenuation:AUTO OFF ON 0 1</code>
	<code>[:SENSE] :POWER [:RF] :ATTenuation:AUTO?</code>

Amplitude Y Scale (AMPTD Y Scale)

Example:	POW:ATT 20 Sets the attenuator to manual mode, and sets the value to 20 dB.
Dependencies/Couplings:	<p>When the electrical attenuator is enabled, the mechanical attenuator has no auto setting and Auto/Man line on the key disappears. The state of Auto/Man is remembered and restored when the electrical attenuator is once again disabled. If it is restored to man, the mechanical attenuation is set to the sum of the current values of mechanical and electrical attenuation, but if it is restored to Auto it recouples according to the Couplings, below.</p> <p>When the Input Attenuator is in 'auto', it uses the following algorithm to determine a value:</p> $\text{Atten} = \text{ReferenceLevel} + \text{PreAmpGain} + \text{ExternalGain} - \text{RefLevelOffset} - \text{MaxMixerLevel} + \text{IF Gain}.$ <p>Limit this value to be between 6 and 70 dB for MXA (or 60 dB for EXA). No value below 6 dB can ever be chosen by Auto.</p> <p>The resulting value should be rounded up to the largest value possible given the attenuation step setting. That is, 50.01 dB would change to 60 dB (for a 10 dB attenuation step).</p> <p>The "IF Gain" term in the equation above is either 0 dB or +10 dB, depending in a fairly complex fashion on the settings of FFT IF Gain, Swept IF Gain, max Ref Level and the Auto/Man setting of Mech Atten.</p>
Preset:	Auto
State Saved:	Saved in State
Min:	0 dB The mechanical attenuation cannot be decreased below 6 dB with the knob or step keys. To get to a value below 6 dB it has to be directly entered from the keypad or via SCPI. This protects from adjusting the attenuation to a dangerously small value which can put the instrument at risk of damage to input circuitry. However, if the current mechanical attenuation is below 6 dB it can be increased with the knob and step keys, but not decreased.
Max:	EXA: 60 dB MXA: 70 dB
Key Path:	AMPTD Y Scale, Attenuation
Instrument S/W Revision:	Prior to A.02.00

Enable Elec Atten

You can enable or disable the Electrical Attenuator. The Electrical Attenuator offers no significant advantage over the Mechanical Attenuator for front-panel operation. Therefore it is assumed you will use the Mechanical Attenuator when operating the analyzer from the front-panel.

The electronic attenuator is unavailable above 3.6 GHz. Therefore, if the Stop Frequency of the analyzer is > 3.6 GHz then Enable Elec Atten is grayed out. If the Elec Atten is enabled, then the Stop Freq of the analyzer is limited to 3.6 GHz, which is to say the UI start, stop, center frequency and span values are all

limited to a maximum of 3.6 GHz + Frequency Offset.

Remote Command: `[:SENSE] :POWER [:RF] :EATTenuation:STATE OFF|ON|0|1`
`[:SENSE] :POWER [:RF] :EATTenuation:STATE?`

Example: POW:EATT:STAT ON

Dependencies/Couplings: The electronic attenuator is unavailable above 3.6 GHz. Therefore, if the Stop Frequency of the analyzer is > 3.6 GHz then the Elec Atten is grayed out.

If the Internal Preamp is on, meaning it is set to Low Band or Full, the electronic attenuator is unavailable. In this case the Enable Elec Atten key will be OFF and grayed out.

If either of the above is true, if the SCPI command is sent, a generic error indicating that the electronic attenuator is unavailable will be sent.

If the Electronic Attenuator is enabled, then the Stop Freq of the analyzer is limited to 3.6 GHz and the Internal Preamp is unavailable.

Preset: OFF
 State Saved: Saved in instrument state.
 Key Path: **AMPTD Y Scale, Attenuation**
 Instrument S/W Revision: Prior to A.02.00

When the Electrical Attenuator is enabled, the Mechanical Attenuator transitions to a state in which it has no Auto function. Here are the rules for transitioning the Mechanical Attenuator:

When the Electrical Attenuator is enabled:

- The Mechanical Attenuator is initialized to 10 dB (this is its optimal performance setting). You can then set it as desired with SCPI, numeric keypad, step keys, or knob, and it behaves as it normally would in manual mode
- The Auto/Man state of Mech Atten is saved
- The Auto/Man line on the Mech Atten key disappears and the auto rules are disabled
- The Electrical Attenuator is set to 10 dB less than the previous value of the Mechanical Attenuator, within the limitation that it must stay within the range of 0 to 24 dB of attenuation.

Examples:

- Mech Atten at 20 dB. Elec Atten enabled, Mech Atten set to 10 dB, and Elect Atten set to 10 dB. New total attenuation equals value before Elec Atten enabled.
- Mech Atten at 0 dB. Elec Atten enabled, Mech Atten set to 10 dB, and Elect Atten set to 0 dB. New total attenuation does not equal value before Elec Atten enabled.

Amplitude Y Scale (AMPTD Y Scale)

- Mech Atten at 40 dB. Elec Atten enabled, Mech Atten set to 10 dB, and Elect Atten set to 24 dB. New total attenuation does not equal value before Elec Atten enabled.

When the Electrical Attenuator is disabled:

- The Elec Atten key is grayed out
- The Auto/Man state of Mech Atten is restored
- If now in Auto, Mech Atten recouples
- If now in man, Mech Atten sets to the value of total atten that existed before the Elec Atten was disabled. The resulting value should be rounded up to the smallest value possible given the Mech Atten Step setting - (That is, 57 dB would change to 58 dB when Mech Atten Step is 2 dB.)

Elec Atten

You can modify the electrical attenuation using this function

Remote Command:	<code>[:SENSe] :POWer [:RF] :EATTenuation <rel_ampl></code> <code>[:SENSe] :POWer [:RF] :EATTenuation?</code>
Restriction and Notes:	Electrical Attenuation's spec is defined only when Mechanical Attenuation is 6 dB.
Dependencies/Couplings:	When Enable Elec Atten is off, Elec Atten key is grayed out.
Preset:	0 dB
State Saved:	Saved in instrument state.
Min:	0 dB
Max:	24 dB
Key Path:	AMPTD Y Scale, Attenuation
Instrument S/W Revision:	Prior to A.02.00

Adjust Atten for Min Clip

This function is similar to the "Optimize Ref Level" function in some measurements in the Agilent PSA and ESA analyzers. Its purpose is to set the combination of mechanical and electrical attenuation based on the current measured signal level so that clipping will be at a minimum.

This is a "one-time" function, that is, it executes once, when the key is pressed.

This key is grayed out in measurements that do not support this functionality. The spectrum analyzer measurement, Swept SA, does not support this functionality.

Remote Command:	<code>[:SENSe] :POWer [:RF] :RANGe:OPTimize IMMEDIATE</code>
Key Path:	AMPTD Y Scale, Attenuation
Instrument S/W Revision:	Prior to A.02.00

The algorithm to be used is as follows:

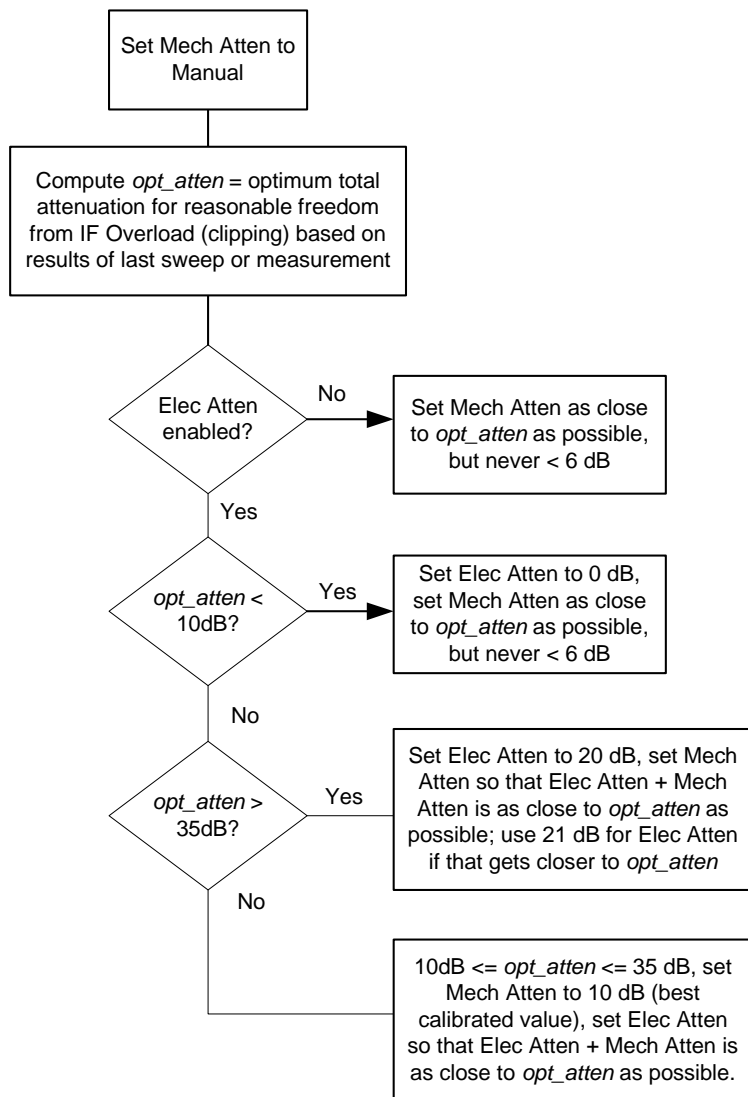

vsd04

Pre-Adjust for Min Clip

This adjustment executes each time a measurement restarts. Therefore, in Continuous, it only executes before the first measurement.

This key is grayed out in measurements that do not support this functionality. The spectrum analyzer measurement, Swept SA, does not support this functionality.

Remote Command: `[:SENSE] :POWER [:RF] :RANGE:OPTimize:ATTenuation
OFF | ELECTrical | COMBined
[:SENSe] :POWER [:RF] :RANGE:OPTimize:ATTenuation?`

State Saved: Saved in State

Key Path: **AMPTD Y Scale, Attenuation**

Amplitude Y Scale (AMPTD Y Scale)

Instrument S/W Revision: Prior to A.02.00

Remote Command: [:SENSe] :POWer [:RF] :RANGe:AUTO ON|OFF|1|0
[:SENSe] :POWer [:RF] :RANGe:AUTO?

Remote Command Notes: ON aliases to "Elec Atten Only"
OFF aliases to "Off"
The query returns true if not "Off"

Instrument S/W Revision: Prior to A.02.00

Off

Example: :POW:RANGe:OPT:ATT OFF

Key Path: **AMPTD Y Scale, Attenuation, Pre-Adjust for Min Clip**

Instrument S/W Revision: Prior to A.02.00

Elec Atten Only

Example: :POW:RANGe:OPT:ATT ELEC

Key Path: **AMPTD Y Scale, Attenuation, Pre-Adjust for Min Clip**

Instrument S/W Revision: Prior to A.02.00

Mech + Elec Atten

Example: :POW:RANGe:OPT:ATT COMB

Key Path: **AMPTD Y Scale, Attenuation, Pre-Adjust for Min Clip**

Instrument S/W Revision: Prior to A.02.00

Mech Atten Step

This controls what step size is used when making adjustments to the Input Attenuation.

Remote Command: [:SENSe] :POWer [:RF] :ATTenuation:STEP[:INCRement] 10 dB |
2 dB
[:SENSe] :POWer [:RF] :ATTenuation:STEP[:INCRement] ?

Example: POW:ATT:STEP 2

Dependencies/Couplings:	Blanked in EXA if option FSA (2 dB steps) is not present. Attempts to set it via SCPI will yield the "Option not present" error. When the attenuation step size changes, the current mechanical attenuation value is adjusted (if necessary) to be quantized to the new step size. That is, if step is set to 10 dB, mech atten is increased if necessary so it is a multiple of 10 dB
Remote Command Notes:	Note this feature works like a 1-N choice from the front panel, but it takes a specific value (in dB) when used remotely. The only valid values are 2 and 10.
Preset:	MXA: 2 dB EXA: 10 dB (2 dB with option FSA)
State Saved:	Saved in State
Key Path:	AMPTD Y Scale, Attenuation
Instrument S/W Revision:	Prior to A.02.00

Max Mixer Level

The Max Mixer Level controls the limitation on the Ref Level for a given attenuation setting, and therefore also interacts with the Auto rules for selecting the attenuation as a coupling from the reference level.

Remote Command:	<code>[:SENSE] :POWER [:RF] :MIXer:RANGe [:UPPer] <real></code> <code>[:SENSe] :POWER [:RF] :MIXer:RANGe [:UPPer] ?</code>
Example:	<code>POW:MIX:RANG -15 dBm</code>
Preset:	-10 dBm
State Saved:	Saved in State
Min:	-50 dBm
Max:	-10 dBm
Key Path:	AMPTD Y Scale, Attenuation
Default Unit:	Depends on the current selected Y axis unit, see Swept SA discussion of Y Axis Unit
Instrument S/W Revision:	Prior to A.02.00

Amplitude Y Scale (AMPTD Y Scale)

Range

This key is only available when I/Q is the selected input. It replaces the Attenuation key in that case.

Each input channel (I and Q) has four internal gain ranges. The maximum allowed voltage in each gain range is slightly more than the nominal value, so the break point between ranges is a couple millivolts higher than the nominal (setting a peak voltage of 0.502 mV will still map to the 0.5 V Peak range).

Gain Setting	Volts RMS	Volts Peak	Volts Peak - Peak	dBm (50Ω)	Break Point
0 dB	0.7071	1.0	2.0	10	n/a
6 dB	0.3536	0.5	1.0	4	0.502 V Peak
12 dB	0.1768	0.25	0.5	-2	0.252 V Peak
18 dB	0.0884	0.125	0.25	-8	0.127 V Peak

Restriction and Notes	Visible only when the selected input is I/Q.
Key Path	AMPTD Y Scale
State Saved	No
Readback Text	When Range is Auto, "[Auto]" When Range is Man and I & Q are the same, "[<range value>]" When Range is Man and I & Q are different: "[I: <I range value> Q: <Q range value>]" See I Range and Q Range for the <range value> enumeration definition.
Instrument S/W Revision	Prior to A.02.00

Range Auto/Man

The Auto setting for Range will cause the range to be set based on the Y Scale settings. When Range is "Auto", the I & Q Range are set based on the top of the Y Scale when the Y scale is in dB units (for example, power), or to the max(abs(top), abs(bottom)) when the Y scale reference is not at top of screen.

Not all measurements support Range Auto/Man. If Auto is not supported in the current measurement, this key is grayed out and shows "Man" and MAN is returned to a SCPI query; but this does NOT change the Meas Global Auto/Man for Range, so when you go to a measurement that supports Auto, it goes back to Auto if it was previously in Auto.

Remote Command	<code>[:SENSe] :VOLTage:IQ:RANGe:AUTO OFF ON 0 1</code> <code>[:SENSe] :VOLTage:IQ:RANGe:AUTO?</code>
-----------------------	--

Dependencies/Couplings	When in Auto, both I Range and Q Range are set to the same value, computed as follows: Maximum absolute value is computed for the Y Scale. The top and bottom of the graph are computed based on Ref Value, Scale/Div, and Ref Position. Formula: YMax = max(abs(top), abs(bottom)). The I Range and Q Range are then set to YMax. If Auto is not supported, sending the SCPI command will generate an error.
Example	Put the I Range and Q Range in manual. VOLT:IQ:RANG:AUTO OFF
Key Path	AMPTD Y Scale, Range
Preset	ON
State Saved	Saved in instrument state.
Range	Auto Man
Instrument S/W Revision	Prior to A.02.00

This is an alternate form of the SCPI command to match the POWer form of the I Range and Q Range SCPI.

Remote Command:	[:SENSE] :POWER: IQ:RANGe:AUTO OFF ON 0 1 [:SENSe] :POWER: IQ:RANGe:AUTO?
Preset:	ON
Range:	Auto Man
Remote Command Notes:	The POW:IQ:RANG:AUTO is an alternate form of the VOLT:IQ:RANG:AUTO command. This is to maintain consistency with I Range and Q Range, which support both the POWER and VOLTage forms of the command.
Example:	Put the I Range and Q Range in manual. POW:IQ:RANG:AUTO OFF
Instrument S/W Revision:	Prior to A.02.00

I Range

This is the internal gain range for the I channel when Input Path is I Only or Ind I/Q, and it is used for both the I and Q channels when Input Path is I+jQ. See [“I/Q Gain Ranges” on page 455](#).

Remote Command	[:SENSE] :VOLTage: IQ [: I] :RANGe [:UPPer] <voltage> [:SENSe] :VOLTage: IQ [: I] :RANGe [:UPPer] ?
Dependencies/Couplings	When Q Same as I is On, the I Range value will be copied to the Q Range. Changing the value will also set Range = Man.

Amplitude Y Scale (AMPTD Y Scale)

Remote Command Notes	The numeric entries are mapped to the smallest gain range whose break point is greater than or equal to the value, or 1 V Peak if the value is greater than 1 V.
Example	Set the I Range to 0.5 V Peak VOLT:IQ:RANG 0.5 V
Key Path	AMPTD Y Scale, Range
Preset	1 V Peak
State Saved	Saved in instrument state.
Range	1 V Peak 0.5 V Peak 0.25 V Peak 0.125 V Peak
Instrument S/W Revision	Prior to A.02.00

This is an alternate form of the SCPI command to allow entry as a power.

Remote Command:	<code>[:SENSE] :POWER:IQ [:I] :RANGE [:UPPER] <ampl></code> <code>[:SENSE] :POWER:IQ [:I] :RANGE [:UPPER] ?</code>
Preset:	10.0 dBm
Range:	-20 dBm to 10 dBm
Min:	-20 dBm
Max:	10 dBm
Remote Command Notes:	The POWER form of the command is provided for convenience. It maps to the same underlying gain range parameter as the VOLTage form of the command. The Reference Z (not the I channel Input Z) is used to convert the power to peak voltage, which is then used to set the I Range as with the VOLTage form of the command. The power values of the 4 range states (1V Peak, 0.5V Peak, 0.25V Peak, and 0.125V Peak) will vary with Reference Z. Here are some examples: 50Ω: 10, 4, -2, -8 75Ω: 8.2, 2.2, -3.8, -9.8 600Ω: -0.8, -6.8, -12.8, -18.9
Example:	Set the I Range to 0.5 V Peak when Reference Z is 50Ω, and to 1.0 V Peak when Reference Z is 75Ω POW:IQ:RANG 4 dBm
Instrument S/W Revision:	Prior to A.02.00

Q Range

Bring up the Q Range menu.

Key Path	AMPTD Y Scale, Range
Readback Text	Q Same as I 1 V Peak 0.5 V Peak 0.25 V Peak 0.125 V Peak When Q Same as I is On, the readback is "Q Same as I", otherwise it is the Q Range value.
Instrument S/W Revision	Prior to A.02.00

Q Same as I

Many, but not all, usages require the I and Q channels have an identical setup. To simplify channel setup, the Q Same as I will cause the Q channel range to be mirrored from the I channel. That way you only need to set up one channel (the I channel). The I channel values are copied to the Q channel, so at the time Q Same as I is "Off" the I and Q channel setups will be identical.

Remote Command	[:SENSE] :VOLTage POWer:IQ:MIRRored OFF ON 0 1 [:SENSE] :VOLTage POWer:IQ:MIRRored?
Dependencies/Couplings	When On, the I Range value is mirrored (copied) to the Q Range.
Example	Turn off the mirroring of I Range to Q Range. VOLT:IQ:MIRR OFF POW:IQ:MIRR OFF
Key Path	AMPTD Y Scale, Range, Q Range
Preset	On
State Saved	Saved in instrument state.
Range	On Off
Readback Text	"Q Same as I" when On, otherwise none.
Instrument S/W Revision	Prior to A.02.00

Q Range Value

This is the internal gain range for the Q channel. See "[I/Q Gain Ranges](#)" on page 455. The Q Range only applies to Input Path Q Only and Ind I/Q. For input I+jQ the I Range determines both I and Q channel range settings.

Remote Command	[:SENSE] :VOLTage:IQ:Q:RANGE [:UPPer] <voltage> [:SENSE] :VOLTage:IQ:Q:RANGE [:UPPer] ?
Dependencies/Couplings	When Q Same as I is On, the I Range value will be copied to the Q Range and the range value keys are disabled. Changing the value will also set Range = Man.

Amplitude Y Scale (AMPTD Y Scale)

Remote Command Notes	The numeric entries are mapped to the smallest gain range whose break point is greater than or equal to the value, or 1 V Peak if the value is greater than 1 V. The Q Range is only used for Input Path Q Only and Ind I/Q. For input I+jQ the I Range determines both I and Q channel range settings.
Example	Set the Q Range to 0.5 V Peak VOLT:IQ:Q:RANG 0.5 V
Key Path	AMPTD Y Scale, Range
Preset	1 V Peak
State Saved	Saved in instrument state.
Range	1 V Peak 0.5 V Peak 0.25 V Peak 0.125 V Peak
Instrument S/W Revision	Prior to A.02.00

This is an alternate form of the SCPI command to allow entry as a power.

Remote Command:	<code>[:SENSe] :POWer: IQ:Q:RANGe [:UPPer] <ampl></code> <code>[:SENSe] :POWer: IQ:Q:RANGe [:UPPer] ?</code>
Preset:	10.0 dBm
Range:	-20 dBm to 10 dBm
Min:	-20 dBm
Max:	10 dBm
Remote Command Notes:	The POWer form of the command is provided for convenience. It maps to the same underlying gain range parameter as the VOLTage form of the command. The Reference Z (not the Q channel Input Z) is used to convert the power to peak voltage, which is then used to set the Q Range as with the VOLTage form of the command. The power values of the 4 range states (1V Peak, 0.5V Peak, 0.25V Peak, and 0.125V Peak) will vary with Reference Z. Here are some examples: 50Ω: 10, 4, -2, -8 75Ω: 8.2, 2.2, -3.8, -9.8 600Ω: -0.8, -6.8, -12.8, -18.9
Example:	Will set the Q Range to 0.5 V Peak when Reference Z is 50Ω, and to 1.0 V Peak when Reference Z is 75Ω POW:IQ:Q:RANG 4 dBm
Instrument S/W Revision:	Prior to A.02.00

I/Q Gain Ranges

1 V Peak

Set the channel gain state to 1 Volt Peak.

Key Path	AMPTD Y Scale, I Range Q Range
Instrument S/W Revision	Prior to A.02.00

0.5 V Peak

Set the channel gain state to 1 Volt Peak.

Key Path	AMPTD Y Scale, I Range Q Range
Instrument S/W Revision	Prior to A.02.00

0.25 V Peak

Set the channel gain state to 1 Volt Peak.

Key Path	AMPTD Y Scale, I Range Q Range
Instrument S/W Revision	Prior to A.02.00

0.125 V Peak

Set the channel gain state to 1 Volt Peak.

Key Path	AMPTD Y Scale, I Range Q Range
Instrument S/W Revision	Prior to A.02.00

Presel Center

When this key is pressed, the centering of the preselector filter is adjusted to optimize the amplitude accuracy at the frequency of the selected marker. If the selected marker is not on when Presel Center is pressed, the analyzer will turn on the selected marker, perform a peak search, and then perform centering on the marker's center frequency. If the selected marker is already on and between the start and stop frequencies of the analyzer, the analyzer performs the preselector calibration on that marker's frequency. If the selected marker is already on, but outside the frequency range between Start Freq and Stop Freq, the analyzer will first perform a peak search, then perform centering on the marker's center frequency.

The value displayed on the **Presel Adjust** key will change to reflect the new preselector tuning (see **Presel Adjust**, below).

A number of considerations should be observed to ensure proper operation:

If the selected marker is off, the analyzer will turn on a marker, perform a peak search, and adjust the preselector using the selected marker's frequency. It uses the "highest peak" peak search method unqualified by threshold or excursion, so that there is no chance of a 'no peak found' error. It continues with that peak, even if it is the peak of just noise. Therefore, for this operation to work properly, there

Amplitude Y Scale (AMPTD Y Scale)

should be a signal on screen in a preselected range for the peak search to find.

If the selected marker is already on, the analyzer will attempt the centering at that marker's frequency. There is no preselector for signals below about 3.6 GHz, therefore if the marker is on a signal below 3.6 GHz, no centering will be attempted and an advisory message generated

When centering the preselector, *OPC will not return true until the process is complete and a subsequent measurement has completed, nor will results be returned to a READ or MEASure command. Note further that if the analyzer is in a measurement such as averaging when this happens, the act of centering the preselector will restart averaging but the first average trace will not be taken until the centering is completed.

Remote Command:	<code>[:SENSe] :POWer [:RF] :PCENter</code>
Example:	POW:PCEN
Dependencies/Couplings:	<ul style="list-style-type: none">• Grayed out if microwave preselector is off (see Input/Output, Microwave Preselector On/Off)• If the selected marker's frequency is below Band 1, advisory 0.5001 is generated and no action is taken.• Grayed out if entirely in Band 0.• Blank in models that do not include a preselector, such as option 503. If the SCPI is sent in such models, it generates an error.• Active marker position determines where the centering will be attempted.
Remote Command Notes:	Note that the rules outlined above under the key description apply for the remote command as well as the key. Hence, the result of the command is dependent on marker position, etc. Any message shown by the key press is also shown in response to the remote command.
Key Path:	AMPTD Y Scale
SCPI Status Bits/OPC Dependencies:	The Measuring bit should remain set while this command is operating and should not go false until the subsequent sweep/measurement has completed.
Instrument S/W Revision:	Prior to A.02.00

Preselector Adjust

Allows you to manually adjust the preselector filter frequency to optimize its response to the signal of interest. This function is only available when **Presel Center** is available (see **Presel Center**, above), that is, the same gray-out rules apply.

For general purpose signal analysis, using Presel Center is recommended. Centering the filter minimizes the impact of long-term preselector drift. Presel Adjust can be used instead to manually optimize the preselector. One application of manual optimization would be to peak the preselector response, which both optimizes the signal-to-noise ratio and minimizes amplitude variations due to small (short-term) preselector drifting.

Preselector Adjust is a Meas Global parameter.

Remote Command:	<code>[:SENSE] :POWER [:RF] :PADJust <freq></code> <code>[:SENSE] :POWER [:RF] :PADJust?</code>
Example:	<code>POW:PADJ 100KHz</code> <code>POW:PADJ?</code>
Dependencies/Couplings:	<ul style="list-style-type: none"> • Grayed out if microwave preselector is off (see Input/Output, Microwave Preselector On/Off) • Grayed out if entirely in Band 0. • Blank in models that do not include a preselector, such as option 503. If the SCPI is sent in these instruments, it generates an error.
Preset:	0 MHz
State Saved:	The Presel Adjust value set by Presel Center , or by manually adjusting Presel Adjust , is not saved in Instrument State, and does not survive Preset or power cycle.
Min:	-500 MHz
Max:	500 MHz
Key Path:	AMPTD Y Scale
Default Unit:	Hz
Instrument S/W Revision:	Prior to A.02.00
Remote Command:	<code>[:SENSE] :POWER [:RF] :PADJust :PRESelector</code> <code>MWAVE MMWave EXTernal</code> <code>[:SENSE] :POWER [:RF] :PADJust :PRESelector?</code>
Remote Command Notes:	<p><code>[:SENSE] :POWER [:RF] :PADJust :PRESelector MWAVE MMWave EXTernal</code></p> <p>where: MWAVE = 3–26 GHz MMWave = 26–50 GHz EXTernal = External</p> <p>Preselector Selection - PSA had multiple preselectors, and you could select which preselector to center. Since MXA will have only one preselector, the preselector selection key will no longer be available. However, in order to provide backward compatibility, we will support the remote command.</p> <p>The command form is a NOP</p> <p>The query will return MWAVE</p>
Instrument S/W Revision:	Prior to A.02.00

Amplitude Y Scale (AMPTD Y Scale)

Internal Preamp

Accesses keys that control the internal preamps. Turning on the preamp gives a better noise figure, but a poorer TOI to noise floor dynamic range. You can optimize this setting for your particular measurement.

Preamp on/off and Preamp Band are Meas Global parameters.

Remote Command: [:SENSe]:POWer[:RF]:GAIN[:STATe] OFF|ON|0|1
[:SENSe]:POWer[:RF]:GAIN[:STATe]?

Dependencies/Couplings: Preamp is not available on all hardware platforms. If the preamp is not present or is unlicensed, the key is not shown.

The preamp is not available when the electronic attenuator is enabled.

Preset: OFF

State Saved: Saved in state

Key Path: **AMPTD Y Scale**

Instrument S/W Revision: Prior to A.02.00

Remote Command: [:SENSe]:POWer[:RF]:GAIN:BAND LOW|FULL
[:SENSe]:POWer[:RF]:GAIN:BAND?

Dependencies/Couplings: Preamp is not available on all hardware platforms. If the preamp is not present or is unlicensed, the key is not shown.

If a POW:GAIN:BAND FULL command is sent when a low band preamp is available, the preamp band parameter is to LOW instead of FULL, and an "Option not installed" message is generated.

Preset: LOW

State Saved: Saved in state

Key Path: **AMPTD Y Scale, Internal Preamp**

Instrument S/W Revision: Prior to A.02.00

Off

Turns the internal preamp off

Example: :POW:GAIN OFF

Key Path: **AMPTD Y Scale, Internal Preamp**

Readback: Off

Instrument S/W Revision: Prior to A.02.00

Low Band

Sets the internal preamp to use only the low band (0–3.6 GHz)

Example: :POW:GAIN ON
 :POW:GAIN:BAND LOW

Key Path: **AMPTD Y Scale, Internal Preamp**

Readback: Low Band

Instrument S/W Revision: Prior to A.02.00

Full Range

Sets the internal preamp to use its full range. The low band (0–3.6 GHz) is supplied by the low band preamp and the frequencies above 3.6 GHz are supplied by the high band preamp.

The instrument compensates for the preamp gain(s) as it sweeps. For the value of "Int Preamp Gain" in the Ref Level equations, we assume a preamp gain of 20 dB in Low Band Preamp mode and 35 dB in Full Range preamp mode. These gain rules are not dependent on start and stop frequencies. These gains are the maximum gain of the preamp hardware; we will always have the same or less actual gain, providing clipping margin.

The frequency range of the installed (optional) preamp is displayed in square brackets on the key label. If the high band option is not installed the Full Range key does not appear.

Example: :POW:GAIN ON
 :POW:GAIN:BAND FULL

Key Path: **AMPTD Y Scale, Internal Preamp**

Readback: Full Range

Instrument S/W Revision: Prior to A.02.00

Amplitude Y Scale (AMPTD Y Scale)

AUTO COUPLE

The Auto Couple feature provides a quick and convenient way to automatically couple multiple instrument settings. This helps ensure accurate measurements and optimum dynamic range. When the Auto Couple feature is activated, either from the front panel or remotely, all parameters of the current measurement which have an Auto/Manual mode are set to Auto mode and all measurement settings dependent on (or coupled to) the Auto/Man parameters are automatically adjusted for optimal performance.

However, the Auto Couple key is meas local key, so its actions are confined to the current measurement only. It does not affect other measurements in the mode, and it does not affect markers, marker functions, or trace or display attributes.

Remote Command: :COUPLe ALL|NONE

Example: :COUP ALL

Remote Command Notes: :COUPLe ALL puts all Auto/Man parameters in Auto mode (equivalent to pressing the **Auto Couple** key).

:COUPLE NONE puts all Auto/Man parameters in manual mode. It decouples all the coupled instrument parameters and is not recommended for making measurements.

Key Path: **Front-panel key**

Instrument S/W Revision: Prior to A.02.00

AUTO COUPLE

BW

Bandwidth features are unique to each Measurement. See the specific Measurement for more information.

The front panel key accesses keys to control measurement bandwidth settings.

Key Path	Front panel key
Instrument S/W Revision	Prior to A.02.00

BW

Cont (Continuous Measurement/Sweep)

Sets the analyzer for Continuous measurement operation. The single/continuous state is Meas Global so the setting will affect all measurements. If you are Paused, pressing Cont does a Resume.

Remote Command:	:INITiate:CONTinuous OFF ON 0 1 :INITiate:CONTinuous?
Example:	:INIT:CONT 0 puts analyzer in Single measurement operation. :INIT:CONT 1 puts analyzer in Continuous measurement operation
Preset:	ON SYST:PRESet sets INIT:CONT to ON but *RST sets INIT:CONT to OFF.
State Saved:	Saved in Instrument State
Key Path:	Front-panel key
Instrument S/W Revision:	Prior to A.02.00

In Swept SA Measurement (Spectrum Analysis Mode):

The analyzer takes repetitive sweeps, averages, measurements, etc. when in Continuous mode. When the average count reaches the **Average/Hold Number** the count stops incrementing but the analyzer keeps sweeping. See the Trace/Detector section for the averaging formula used both before and after the **Average/Hold Number** is reached. The trigger condition must be met prior to each sweep. The type of trace processing for multiple sweeps, is set under the Trace/Detector key, with choices of **Trace Average, Max Hold, or Min Hold**.

In Other Measurements/Modes:

With **Avg Number** (in **Meas Setup** menu) set to **Off** or set to **On** with a value of 1, a sweep is taken after the trigger condition is met; and the analyzer continues to take new sweeps after the current sweep has completed and the trigger condition is again met. However, with **Avg Number** set to On with a value >1, multiple sweeps (data acquisitions) are taken for the measurement. The trigger condition must be met prior to each sweep. The sweep is not stopped when the average count k equals the number N set for Avg Number is reached, but the number k stops incrementing. A measurement average usually applies to all traces, marker results, and numeric results. But sometimes it only applies to the numeric results.

If the analyzer is in Single measurement, pressing the **Continuous** key does not change k and does not cause the sweep to be reset; the only action is to put the analyzer into Continuous measurement operation.

If it is already in continuous sweep:

the INIT:CONT 1 command has no effect

the INIT:CONT 0 command will place the analyzer in Single Sweep but will have no effect on the current sequence until $k = N$, at which point the current sequence will stop and the instrument will go to the idle state.

Cont (Continuous Measurement/Sweep)

FREQ Channel

Accesses a menu allowing you to set Frequency parameters for Phase Noise measurements.

Key Path	Front-panel key
Instrument S/W Revision	Prior to A.02.00

Auto Tune

When this key is pressed, the measurement automatically searches for and tunes to the strongest signal within the currently specified search span.

Remote Command	<code>[:SENSe] :FREQuency:CARRier:SEARch</code>
Example	<code>FREQ:CARR:SEAR</code>
Key Path	FREQ Channel
Mode	PN
Instrument S/W Revision	Prior to A.02.00

Carrier Freq

Specifies the center frequency of the carrier

Remote Command	<code>[:SENSe] :FREQuency:CARRier <freq></code> <code>[:SENSe] :FREQuency:CARRier?</code>
Example	<code>FREQ:CARR 1</code> <code>FREQ:CARR?</code>
Key Path	FREQ Channel
Mode	PN
Notes	When Signal Track is ON, Carrier Frequency is automatically set depending on the signal. When Auto Tune is performed, Carrier Frequency is automatically set as the result of Auto Tuning algorithm.
Preset	1GHz
State Saved	Saved in instrument state.
Min	-79.999995 MHz

FREQ Channel

Max	Hardware Dependent: Opt503 = 3.69999995 GHz Opt508 = 8.49999995 GHz Opt513 = 13.79999995 GHz Opt526 = 26.99999995 GHz
Instrument S/W Revision	Prior to A.02.00

Signal Track

Selects whether or not the analyzer tracks a slowly drifting signal. When signal tracking is Off, the analyzer measures at a fixed frequency. When signal tracking is On, the analyzer repeatedly measures the center frequency of the carrier signal on every acquisition to check for any change that might have occurred, and returns to the new frequency if necessary.

Remote Command	<code>[:SENSE] :FREQuency:CARRier:TRACk [:STATe] OFF ON 0 1</code> <code>[:SENSe] :FREQuency:CARRier:TRACk [:STATe] ?</code>
Example	<code>FREQ:CARR:TRAC</code> <code>FREQ:CARR:TRAC?</code>
Key Path	FREQ Channel
Mode	PN
Notes	Signal Tracking assumes the new acquisition occurs repeatedly without pause. If the acquisition is paused, the drifting frequency might be bigger than the tracking algorithm expects, in that case, the analyzer might lose the frequency of carrier. Then, the user can perform Auto Tune to find the carrier again. Repeated realignment of the carrier signal when signal tracking is On causes measurements to take slightly longer than when signal tracking is Off
Preset	ON
State Saved	Saved in instrument state.
Instrument S/W Revision	Prior to A.02.00

Tracking

Accesses the menu for tracking parameters.

Key Path	FREQ Channel
Instrument S/W Revision	Prior to A.02.00

Span

Specifies the frequency span for signal tracking functionality. The analyzer searches for the carrier signal from $\text{CurrentCenterFrequency} - (\text{Span} / 2)$ to $\text{CurrentCenterFrequency} + (\text{Span} / 2)$. A smaller span will provide a more precise result for signal tracking.

Remote Command	[:SENSe]:FREQuency:CARRier:TRACk:SPAN <freq> [:SENSe]:FREQuency:CARRier:TRACk:SPAN? [:SENSe]:FREQuency:CARRier:TRACk:SPAN:AUTO ON OFF 1 0 [:SENSe]:FREQuency:CARRier:TRACk:SPAN:AUTO?
-----------------------	--

Example	FREQ:CARR:TRAC:SPAN 100kHz FREQ:CARR:TRAC:SPAN? FREQ:CARR:TRAC:SPAN:AUTO ON FREQ:CARR:TRAC:SPAN:AUTO?
---------	--

Dependencies/Couplings	When a value other than the default is set, it turns span auto mode to OFF. When AUTO is specified, the span value turns back to default.
------------------------	--

Key Path	FRREQ Channel, Tracking
Mode	PN
Preset	51kHz ON
State Saved	Saved in instrument state.
Min	10.0 kHz
Max	Hardware Dependent: No option = 10MHz Option B25 = 25MHz
Instrument S/W Revision	Prior to A.02.00

FREQ Channel

Accuracy

Specifies the accuracy of signal tracking functionality. Tracking with higher accuracy takes longer.

Remote Command	<code>[:SENSe] :FREQuency:CARRier:TRACk:ACCuracy LOW MED HIGH</code> <code>[:SENSe] :FREQuency:CARRier:TRACk:ACCuracy?</code>
Example	<code>FREQ:CARR:TRAC:ACC LOW</code> <code>FREQ:CARR:TRAC:ACC?</code>
Key Path	FREQ Channel, Tracking
Mode	PN
Preset	MED
State Saved	Saved in instrument state.
Range	Low (Slowest) Medium High (Fastest)
Instrument S/W Revision	Prior to A.02.00

Input/Output

The Input/Output features are common across multiple Modes and Measurements. These common features are described in this section. See the Measurement description for information on features that are unique.

The Input/Output key accesses the keys that control the Input/Output parameters of the instrument. In general, these are functions associated with external connections to the analyzer, either to the inputs or the outputs. Since these connections tend to be fairly stable within a given setup, in general the input/output settings do not change when you Preset the analyzer.

Other functions related to the input/output connections, but which tend to change on a measurement by measurement basis, can be found under **Trig** and **Amplitude**. In addition, some of the digital I/O bus configurations can be found under **System**.

NOTE The functions in the Input/Output menu are "global" (common) to all Modes (applications). But individual Input/Output functions only appear in a Mode if they apply to that Mode. Functions that apply to a Mode but not to all measurements in the Mode may be grayed out in some measurements.

The Input Port selection is the first menu under Input/Output:

Remote Command:	[:SENSe] :FEED RF AIQ IQ IONLy QONLy AREFERENCE [:SENSe] :FEED?
Remote Command Notes:	The parameter EXTMixer is for future use and is not supported at this time; sending it generates an error.
Preset:	This setting is unaffected by a Preset or power cycle. It survives Mode Preset and mode changes. It is set to RF on a "Restore Input/Output Defaults" or "Restore System Defaults->All"
State Saved:	Saved in state
Key Path:	Front-panel key
Instrument S/W Revision:	Prior to A.02.00

Input/Output variables - Preset behavior

Virtually all the input/output settings are NOT a part of mode preset. They can be set to their default value by one of the three ways - by using the Restore Input/Output Defaults key on the first page of the input/output menu, by using the System->Restore System Defaults->Input/Output Settings or by using the System -> Restore System Defaults->All. Also, they survive Preset and Power cycle.

A very few of the Input/Output settings do respond to a Mode Preset; for example, if the Calibrator is on it turns off on a Preset, and if DC coupling is in effect it switches to AC on a Preset. These exceptions are

Input/Output

made in the interest of reliability and usability, which overrides the need for absolute consistency. Exceptions are noted in the SCPI table for the excepted functions.

RF Input

Selects the front panel RF input port to be the analyzer signal input. If RF is already selected, pressing this key accesses the RF input setup functions.

Example:	[[:SENSe]:FEED RF
Key Path:	Input/Output
Readback:	The current input impedance settings are Readback to this key i.e. "XX, ZZ" where XX is AC or DC and ZZ is 50 or 75
Instrument S/W Revision:	Prior to A.02.00

Input Z Correction

Sets the input impedance for unit conversions. This affects the results when the y axis unit is voltage or current units (dBmV, dB μ V, dB μ A, V, A) but not when it is power units (dBm, W). The impedance you select is for computational purposes only, since the actual impedance is set by internal hardware to 50 ohm. Setting the computational input impedance to 75 ohm is useful when using a 75 ohm to 50 ohm adapter to measure a 75 ohm device on an analyzer with 50 ohm input impedance.

There are a variety ways to make 50 to 75 ohm transitions, such as impedance transformers or minimum loss pads. The choice of the solution that is best for your measurement situation requires balancing the amount of loss that you can tolerate with the amount of measurement frequency range that you need. If you are using one of these pads/adaptors with the **Input Z Corr** function, you might also want to use the **Ext Gain** key. This function is used to set a correction value to compensate for the gain (loss) through your pad. This correction factor is applied to the displayed measurement values.

Remote Command:	[[:SENSe]:CORRection:IMPedance[:INPut][:MAGNitude] 50 75 [:SENSe]:CORRection:IMPedance[:INPut][:MAGNitude]?
Example:	CORR:IMP 75 sets the input impedance correction to 75 ohms. CORR:IMP?
Preset:	This is unaffected by Preset but is set to 50 ohms on a "Restore Input/Output Defaults" or "Restore System Defaults->All" Some instruments/options may have 75 ohms available.
State Saved:	Saved in State
Key Path:	Input/Output, RF Input
Readback:	50 or 75. Current setting reads back to the RF key.
Instrument S/W Revision:	Prior to A.02.00

RF Coupling

Specifies alternating current (AC) or direct current (DC) coupling at the analyzer RF input port. Selecting AC coupling switches in a blocking capacitor that blocks any DC voltage present at the analyzer input. This decreases the input frequency range of the analyzer, but prevents damage to the input circuitry of the analyzer if there is a DC voltage present at the RF input.

In AC coupling mode, you can view signals less than 10 MHz but the amplitude accuracy is not specified. To accurately see a signal of less than 10 MHz, you must switch to DC coupling.

Some amplitude specifications apply only when coupling is set to DC. Refer to the appropriate amplitude specifications and characteristics for your analyzer.

When operating in DC coupled mode, ensure protection of the analyzer input circuitry by limiting the DC part of the input level to within 200 mV of 0 Vdc. In AC or DC coupling, limit the input RF power to +30 dBm (1 Watt).

Selecting Input Coupling

X-Series Option	AC Frequency Range	N9010A DC Frequency Range	N9020A DC Frequency Range
Option 503	10 MHz to 3.6 GHz	9 kHz to 3.6 GHz	3 Hz to 3.6 GHz
Option 507	10 MHz to 7.0 GHz	9 kHz to 7.0 GHz	
Option 508	10 MHz to 8.4 GHz		3 Hz to 8.4 GHz
Option 513	10 MHz to 13.6 GHz	9 kHz to 13.6 GHz	3 Hz to 13.6 GHz
Option 526	10 MHz to 26.5 GHz	9 kHz to 26.5 GHz	3 Hz to 26.5 GHz

Remote Command: :INPut:COUPling AC|DC
 :INPut:COUPling?

Example: INP:COUP DC

Preset: AC

State Saved: Saved in State

Key Path: **Input/Output, RF Input**

Instrument S/W Revision: Prior to A.02.00

I/Q

This feature is not available unless the Baseband I/Q option (BBA) is installed.

Selects the front panel I/Q input ports to be the analyzer signal input. If I/Q is already selected, pressing this key accesses the I/Q setup menu.

Restriction and Notes Not all measurements support the use of the I/Q signal input. When I/Q is selected in a measurement that does not support it, the "Meas invalid with I/Q inputs" error condition occurs.

Input/Output

Remote Command Notes	<p>The parameters IQ IONLy QONLy are only supported for backwards compatibility. The E44406 SCPI has the following that corresponds to FEED:IQ:TYPE for MXA.</p> <p>[[:SENSe]:FEED IQ IONLy QONLy</p> <p>[[:SENSe]:FEED?</p> <p>[[:SENSe]:FEED IQ will set the I/Q path to IQ</p> <p>[[:SENSe]:FEED IONLy will set the I/Q path to I Only</p> <p>[[:SENSe]:FEED QONLy will set the I/Q path to QOnly</p> <p>Note [[:SENSe]:FEED? will not be backward compatible.</p> <p>The query [[:SENSe]:FEED? will always returns AIQ whatever the type of legacy parameters IQ IONLy QONLy has been used.</p>
Example	FEED AIQ
Key Path	Input/Output
Mode	BASIC, CDMA2K, EDGE GSM, TDSCDMA, VSA89601, WIMAX OFDMA
Instrument S/W Revision	Prior to A.02.00

The Baseband I/Q functionality is a hardware option. It is option BBA. If the option is not installed, none of the I/Q functionality is enabled.

The Baseband I/Q has four input ports and one output port. The input ports are I, I-bar, Q, and Q-bar. The I and I-bar together compose the I channel and the Q and Q-bar together compose the Q channel. Each channel has two modes of operation, Single-Ended (also called "unbalanced") and Differential Input (also called "balanced"). When in Single-Ended operation, only the main port (I or Q) is used and the complementary port (I-bar or Q-bar) is ignored. When in Differential Input mode, both main and complementary ports are used.

The input settings (range, attenuation, skew, impedance, external gain) apply to the channels, not the individual ports.

The system supports a variety of 1 M Ω input passive probes as well as the Agilent 113x Series active differential probes using the Infinimax probe interface.

The Agilent 113x Series active probes can be used for both single ended and differential measurements. In either case a single connection is made for each channel (on either the I or Q input). The input is automatically configured to 50 Ω single ended and the probe power is supplied through the Infinimax interface. The probe can be configured for a variety of input coupling and low frequency rejection modes. In addition, a wide range of offset voltages and probe attenuation accessories are supported at the probe interface. The active probe has the advantage that it does not significantly load the circuit under test, even with unity gain probing.

With passive 1 M Ω probes, the probe will introduce a capacitive load on the circuit, unless higher attenuation is used at the probe interface. Higher attenuation reduces the signal level and degrades the signal-to-noise-ratio of the measurement. Passive probes are available with a variety of attenuation values for a moderate cost. Most Agilent passive probes can be automatically identified by the system, setting the input impedance setting required as well as the nominal attenuation. For single ended

measurements a single probe is used for each channel. Other passive probes can be used, with the attenuation and impedance settings configured manually.

For full differential measurements, the system supports probes on each of the four inputs. The attenuation of the probes should be the same for good common mode rejection and channel match.

Both active and passive probes in single ended and differential configurations can be calibrated. This calibration uses the Cal Out BNC connection and a probe connection accessory. The calibration achieves excellent absolute gain flatness in a probed measurement. It matches both the gain and frequency response of the I and Q channels as well as any delay skew, resulting in high accuracy in derived measurements such as Error Vector Magnitude (EVM).

When a probe is connected a status message will be displayed. The message will indicate if calibration data is available or not. Calibration data is saved for each type of probe (including "none") for each port and will be reapplied whenever that type of probe is re-connected to the same port. For probes with EEPROM identification, the calibration data will be stored based on the unique probe identifier and will reapply data for that particular probe if it is available. The data will not follow a probe from one port to another. For probes without EEPROM identification, the instrument cannot distinguish between different probes of the same type and it will use the data from the last calibration for that probe type on that port.

When in differential mode, both the main and complementary probes are expected to be of the same type.

In some situations, the I and Q channels should be configured identically. In other situations it is convenient to control them independently. Some menus have a "Q Same as I" setting that will cause the Q channel configuration to mirror the I channel configuration, avoiding the overhead of double data entry when the channels should be the same.

The output port is for calibrating the I/Q input ports, although it can also be manually controlled.

There are two types of calibrations available: cable calibration and probe calibration. The cable calibration will guide you through connecting each input port in turn. All ports must be calibrated together. The probe calibration is done for a specific channel (I or Q). If in Single-Ended mode, only the main port is calibrated. When in Differential Input mode, you are guided through calibrating both main and complementary ports.

The front panel I/Q port LEDs indicate the current state of that port. On (green) indicates it is active, and off (dark) indicates it is not in use. For example, the Cal Out port LED is on if and only if there is signal coming out of that port.

The input is a context and some parameters have separate values for each context. The SCPI for these parameters has an optional "[:RF|IQ]" node. If the specific context is omitted, the command acts on the current input context's value. Here are the parameters that are input context sensitive:

- Center Frequency
- Trigger Source

It is important to distinguish between the I and Q input ports and the displayed I and Q data values. The I and Q input ports feed into a digital receiver that does digital tuning and filtering. The I and Q data seen by you (either on the display or through SCPI) corresponds to the real ("I") and the imaginary ("Q") output from the digital receiver. When the input path is $I+jQ$ or I Only and the center frequency is 0 Hz the I input ends up in as the real output from the receiver and appears as "I" data. Likewise, when the input path is $I-jQ$ and the center frequency is 0 Hz, the Q input ends up as the imaginary output from the

Input/Output

receiver and appears as "Q" data. However, when the input path is Q Only, the Q input is sent to the receiver as $Q+j0$, so the receiver output has the Q input coming out on the real output, and so in Q Only, the signal from the Q input port appears as the "I" data. Another situation where the I and Q data do not necessarily correspond directly to the I and Q inputs is when the center frequency is non-zero. The digital processing involved in the tuning is a complex operation. This will result in I Only data appearing as both "I" and "Q" data, the same as that signal would appear if seen through the RF input port.

I/Q Path

Selects which I/Q input channels are active. The LED next to each I/Q input port will be on when that port is active.

The analysis bandwidth for each channel is the same as that of the instrument. So, for example, the base N9020A has a bandwidth of 10 MHz. With I/Q input the I and Q channels would each have an analysis bandwidth of 10 MHz, giving 20 MHz of bandwidth when the I/Q Path is I+jQ. With option B25, the available bandwidth becomes 25 MHz, giving 25 MHz each to I and Q and 50 MHz to I+jQ. With option S40, the available bandwidth becomes 40 MHz, giving 40 MHz each to I and Q, that is 80 MHz to I+jQ.

I/Q voltage to power conversion processing is dependent on the I/Q Path selected.

- With I+jQ input we know that the input signal may not be symmetrical about 0 Hz, because it has a complex component. Therefore, above 0 Hz only the positive frequency information is displayed, and below 0 Hz only the negative frequency information is displayed.
- With all other Input Path selections, the input signal has no complex component and therefore is always symmetrical about 0 Hz. In this case, by convention, the power conversion shows the combined voltage for both the positive and negative frequencies. The information displayed below 0 Hz is the mirror of the information displayed above 0 Hz. This results in a power reading 6.02 dB higher (for both) than would be seen with only the positive frequency voltage. Note also that, in this case the real signal may have complex modulation embedded in it, but that must be recovered by further signal processing.

Remote Command	<code>[:SENSE] :FEED:IQ:TYPE IQ IONLY QONLY</code> <code>[:SENSE] :FEED:IQ:TYPE?</code>
Example	Set the input to be both the I and Q channels, combined as $I + j * Q$. <code>FEED:IQ:TYPE IQ</code>
Key Path	Input/Output, I/Q
Preset	IQ
State Saved	Yes
	This is unaffected by Preset but is set to the default value on a "Restore Input/Output Defaults" or "Restore System Defaults->All"
Range	I+jQ I Only Q Only
Readback Text	I+jQ I Only Q Only
Instrument S/W Revision	Prior to A.02.00

Remote Command: :INPut [1] :IQ:TYPE IQ|I|Q
 :INPut [1] :IQ:TYPE?
 Preset: IQ
 Instrument S/W Revision: Prior to A.02.00

I+jQ

Sets the signal input to be both the I and Q channels. The I and Q channel data will be combined as $I + j * Q$.

Example Set the input to be both the I and Q channels, combined as $I + j * Q$.
 FEED:IQ:TYPE IQ

Key Path **Input/Output, I/Q, I/Q Path**
 Instrument S/W Revision Prior to A.02.00

I Only

Sets the signal input to be only the I channel. The Q channel will be ignored. The data collected is still complex. When the center frequency is 0 the imaginary part will always be zero, but for any other center frequency both the real and imaginary parts will be significant.

Example Set the input to be only the I channel.
 FEED:IQ:TYPE IONL

Key Path **Input/Output, I/Q, I/Q Path**
 Instrument S/W Revision Prior to A.02.00

Q Only

Sets the signal input to be only the Q channel. The I channel will be ignored. The Q channel will be sent to the digital receiver block as $Q+j0$. The receiver's output is still complex. When the center frequency is 0 the imaginary part will always be zero, but for any other center frequency both the real and imaginary parts will be significant. Note that since the receiver's real output is displayed as the "I" data, when the center frequency is 0, the Q Only input appears as the "I" data.

Example Set the input to be only the Q channel.
 FEED:IQ:TYPE QONL

Key Path **Input/Output, I/Q, I/Q Path**
 Instrument S/W Revision Prior to A.02.00

Input/Output

I Setup

Accesses the channel setup parameters for the I channel.

Key Path	Input/Output, I/Q
Instrument S/W Revision	Prior to A.02.00

I Differential Input

Selects differential input on or off for the I channel. For differential input (also called balanced input), the analyzer uses both main and complementary ports. When differential input is off (also called single-ended or unbalanced input), the analyzer uses only the main port.

Remote Command	<code>:INPut:IQ[:I]:DIFFerential OFF ON 0 1</code> <code>:INPut:IQ[:I]:DIFFerential?</code>
Dependencies/Couplings	Some active probes include built-in differential capability. When one of these probes is sensed, this key is disabled. Since the differential capability is handled in the probe, the Analyzer will use only the main port and the key will show that the Analyzer's Differential Input mode is Off (indicating that the complementary port not in use). When Q Same as I is On, the value set for I will also be copied to Q.
Restriction and Notes	When Differential Input = On, the analyzer will check for attenuation mismatches between the I and I-bar ports. If the difference in attenuation values exceeds 0.5 dB an error condition will be set.
Example	Put the I channel in Differential Input mode <code>INP:IQ:DIFF ON</code>
Key Path	Input/Output, I/Q, I Setup
Preset	Off
State Saved	Yes This is unaffected by Preset but is set to the default value on a "Restore Input/Output Defaults" or "Restore System Defaults->All"
Range	Off On
Instrument S/W Revision	Prior to A.02.00
Remote Command:	<code>:INPut [1] :IQ:BALanced[:STATe] OFF ON 0 1</code> <code>:INPut [1] :IQ:BALanced[:STATe] ?</code>
Preset:	OFF
Remote Command Notes:	This backwards compatibility SCPI command was for an instrument without independent settings for the I and Q channels. Therefore, it is tied only to the I channel and does not provide an equivalent for the Q channel. For proper operation of the backwards compatibility command Q Same as I should be set to On.

Instrument S/W Revision: Prior to A.02.00

I Input Z

Selects the input impedance for the I channel. The impedance applies to both the I and I-bar ports.

The input impedance controls the hardware signal path impedance match. It is not used for converting voltage to power. The voltage to power conversion always uses the Reference Z parameter. The Reference Z parameter applies to both I and Q channels.

Remote Command	:INPut [1] :IQ[:I] :IMPedance LOW HIGH :INPut [1] :IQ[:I] :IMPedance?
Dependencies/Couplings	Input impedance is a built-in characteristic of a probe. Therefore, whenever a probe is sensed, this key is disabled and the value is set to match the probe. When no probe is sensed on Q and Q Same as I is On, the value set for I will also be copied to Q.
Remote Command Notes	LOW = 50 Ω , HIGH = 1 M Ω
Example	Set the I channel input impedance to 1 M Ω INP:IQ:IMP HIGH
Key Path	Input/Output, I/Q, I Setup
Preset	LOW
State Saved	Yes This is unaffected by Preset but is set to the default value on a "Restore Input/Output Defaults" or "Restore System Defaults->All"
Range	50 Ω 1 M Ω
Instrument S/W Revision	Prior to A.02.00

I Skew

This command sets the skew factor for the I channel. The skew will shift the channel's data in time. Use this to compensate for differences in the electrical lengths of the input paths due to cabling.

Remote Command	[:SENSe] :CORRection:IQ[:I] :SKEW <seconds> [:SENSe] :CORRection:IQ[:I] :SKEW?
Example	Delay the data for the I channel by 10 ns. CORR:IQ:SKEW 10 ns
Key Path	Input/Output, I/Q, I Setup
Preset	0

Input/Output

State Saved	Yes
	This is unaffected by Preset but is set to the default value on a "Restore Input/Output Defaults" or "Restore System Defaults->All"
Range	0 s to 100 ns
Instrument S/W Revision	Prior to A.02.00

I Probe

Access the probe setup parameters for the I channel. See [“I/Q Probe Setup” on page 484](#).

Key Path	Input/Output, I/Q, I Setup
State Saved	No
Readback Text	[<I port probe id>] This is reporting the type of probe sensed on the I port. There is no parameter for overriding what is sensed.
Instrument S/W Revision	Prior to A.02.00

Combined Differential/Input Z

This is SCPI only (no front panel) and is for backwards compatibility only. It combines the Differential Input and Input Z selections into a single SCPI command.

Remote Command: :INPut:IMPedance:IQ U50|B50|U1M|B1M
:INPut:IMPedance:IQ?

Preset: U50

Remote Command Notes: The enum values translate as follows:
U50: Differential Input = Off, Input Z = 50Ω
B50: Differential Input = On, Input Z = 50Ω
U1M: Differential Input = Off, Input Z = 1 MΩ
B1M: Differential Input = On, Input Z = 1 MΩ

This command is for backwards compatibility. It combines the Input Z (50Ω or 1 MΩ) parameter with the Differential Input (Off = "Unbalanced", On = "Balanced") parameter into a single enumeration.

This backwards compatibility SCPI command was for an instrument without independent settings for the I and Q channels. Therefore, it is tied only to the I channel and does not provide an equivalent for the Q channel. For proper operation of the backwards compatibility command Q Same as I should be set to On.

Also, note the subtle difference between this SCPI command and the backwards compatibility command for Input Z. The Input Z SCPI has "IQ" before "IMP" while this command has that order reversed.

Dependencies/Couplings:	This command does not have an independent parameter, but instead is tied to the Differential Input and Input Z parameters. The coupling for those parameters apply to this command too.
Example:	:INPut:IMPedance:IQ U50 This is equivalent to the following two SCPI commands: :INP:IQ:DIFF OFF :INP:IQ:IMP 50
Instrument S/W Revision:	Prior to A.02.00

Q Setup

Accesses the channel setup parameters for the Q channel.

Key Path	Input/Output, I/Q
Readback Text	When Q Same as I is On the readback is "Q Same as I".
Instrument S/W Revision	Prior to A.02.00

Q Same as I

Many, but not all, usages require the I and Q channels have an identical setup. To simplify channel setup, the Q Same as I will cause the Q channel parameters to be mirrored from the I channel. That way you only need to set up one channel (the I channel). The I channel values are copied to the Q channel, so at the time Q Same as I is turned off the I and Q channel setups will be identical. This does not apply to Probe settings or to parameters that determined by the probe.

Remote Command	:INPut:IQ:MIRROred OFF ON 0 1 :INPut:IQ:MIRROred?
Dependencies/Couplings	Only displayed for the Q channel. When Yes, the I channel values for some parameters are mirrored (copied) to the Q channel. However, when a parameter is determined by the type of probe and a probe is sensed, the probe setting is always used and the I channel setting is ignored. The following parameters are mirrored: Differential Input (when not determined by probe) Input Z (when not determined by probe)
Example	Turn off the mirroring of parameters from I to Q. INP:IQ:MIRR OFF
Key Path	Input/Output, I/Q, Q Setup
Preset	This is unaffected by Preset but is set to the default value (Q Same as I set to "On") on a "Restore Input/Output Defaults" or "Restore System Defaults->All"
State Saved	Saved in instrument state.

Input/Output

Range	On Off
Readback Text	"Q Same as I" when On, otherwise none.
Instrument S/W Revision	Prior to A.02.00

Q Differential Input

Selects differential input on or off for the Q channel. For differential input (also called balanced input), the analyzer uses both the Q and Q-bar ports. When differential input is off (also called single-ended or unbalanced input), the analyzer uses only the Q port.

Remote Command	<code>:INPut:IQ:Q:DIFFerential OFF ON 0 1</code> <code>:INPut:IQ:Q:DIFFerential?</code>
Dependencies/Couplings	Some active probes include built-in differential capability. When one of these probes is sensed, this key is disabled. Since the differential capability is handled in the probe, the Analyzer will use only the main port and the key will show that the Analyzer's Differential Input mode is Off (indicating that the complementary port not in use). When a differential probe is not sensed and Q Same as I is On, the value set for I will be copied to Q. This key is disabled when Q Same as I is On.
Restriction and Notes	When Differential Input = On, the analyzer will check for attenuation mismatches between the Q and Q-bar ports. If the difference in attenuation values exceeds 0.5 dB an error condition will be set.
Example	Put the Q channel in Differential Input mode <code>INP:IQ:Q:DIFF ON</code>
Key Path	Input/Output, I/Q, Q Setup
Preset	Off
State Saved	On This is unaffected by Preset but is set to the default value on a "Restore Input/Output Defaults" or "Restore System Defaults->All"
Range	Off On
Instrument S/W Revision	Prior to A.02.00

Q Input Z

Selects the input impedance for the Q channel. The impedance applies to both the Q and Q-bar ports.

The input impedance controls the hardware signal path impedance match. It is not used for converting voltage to power. The voltage to power conversion always uses the Reference Z parameter. The Reference Z parameter applies to both I and Q channels.

Remote Command	<code>:INPut [1] :IQ:Q:IMPedance LOW HIGH</code> <code>:INPut [1] :IQ:Q:IMPedance?</code>
-----------------------	--

Dependencies/Couplings	Input impedance is a built-in characteristic of a probe. Therefore, whenever a probe is sensed, this key is disabled and the value is set to match the probe. When no probe is sensed and Q Same as I is On, the value set for I will also be copied to Q. This key is disabled when Q Same as I is On.
Remote Command Notes	LOW = 50 Ω , HIGH = 1 M Ω
Example	Set the Q channel input impedance to 1 M Ω INP:IQ:Q:IMP HIGH
Key Path	Input/Output, I/Q, Q Setup
Preset	LOW
State Saved	On This is unaffected by Preset but is set to the default value on a "Restore Input/Output Defaults" or "Restore System Defaults->All"
Range	50 Ω 1 M Ω
Instrument S/W Revision	Prior to A.02.00

Q Skew

This command sets the skew factor for the Q channel. The skew will shift the channel's data in time. Use this to compensate for differences in the electrical lengths of the input paths due to cabling and probes.

Remote Command	[:SENSE] :CORREction:IQ:Q:SKEW <seconds> [:SENSe] :CORREction:IQ:Q:SKEW?
Example	Delay the data for the Q channel by 10 ns. CORR:IQ:Q:SKEW 10 ns
Key Path	Input/Output, I/Q, Q Setup
Preset	0
State Saved	Yes This is unaffected by Preset but is set to the default value on a "Restore Input/Output Defaults" or "Restore System Defaults->All"
Range	0 s to 100 ns
Instrument S/W Revision	Prior to A.02.00

Q Probe

Accesses the probe setup parameters for the Q channel. See ["I/Q Probe Setup"](#) on page 484.

Key Path	Input/Output, I/Q, Q Setup
State Saved	No

Input/Output

Readback Text	[<Q port probe id>] This is reporting the type of probe sensed on the Q port. There is no parameter for overriding what is sensed.
Instrument S/W Revision	Prior to A.02.00

I/Q Probe Setup

The set of I/Q probe setup parameters change based on the type of probe that is sensed. All probe types have the Attenuation parameter, and all probe types can be calibrated. The remaining parameters are only available for some probe types and will not be shown when not available. The probe type is determined by and reported for only for the I and Q ports, never the I-bar or Q-bar ports. The menu title will be "<ch>: <probe id>", where "<ch>" is either "I" or "Q" and "<probe id>" is the type of probe. For example, for the I Probe setup with an Agilent 1130A probe connected to the I port, the title will be "I: 1130A".

Probe calibration data is stored for each probe type for each channel. When no probe is sensed, the probe type "Unknown" is used, and this is also is treated like a probe type with its own calibration data. When a probe is changed, the calibration data for that probe type for that port is restored. An advisory message will be displayed showing the new probe type and the calibration status. The calibration data is stored permanently (survives power cycle) and is not affected by Preset or any of the Restore commands. When the probe has EEPROM identification (most newer Agilent probes have this), the calibration data is stored by probe serial number and port, so if you have two probes of the same type, the correct calibration data will be used for each. For probes that do not have EEPROM identification, the calibration data is stored by probe type and port and the instrument cannot distinguish between different probes of the same type. In all cases (with or without EEPROM identification), the calibration data is port specific, so it will not follow a specific probe from port to port if the probe is moved.

The "Unknown" probe type is used whenever no probe is sensed. When no calibration data exists for "Unknown" the latest cable calibration data is used (see [“I/Q Guided Calibration” on page 516](#)).

Attenuation

The attenuation is part of the calibration data stored with the probe type and is initially the value that was returned by the last calibration. You are able to modify this value and any changes will be stored with the calibration data and will survive power cycles and presets. When a probe calibration is performed the attenuation value will be overwritten by the calibration.

Remote Command	<code>[:SENSE] :CORRection:IQ:I Q:ATTenuation:RATio <real></code> <code>[:SENSe] :CORRection:IQ:I Q:ATTenuation:RATio?</code>
Restriction and Notes	Each probe type has its own attenuation setting. As probes are changed the attenuation value will reflect the new probe's setting. Changing the attenuation affects only the current probe type's setting and leaves all others unchanged.
Example	Set the attenuation for the current I probe to 100.00:1. <code>CORR:IQ:I:ATT:RAT 100</code>
Key Path	Input/Output, I/Q, I Setup Q Setup, I Probe Q Probe
Preset	Each probe type has its own default. The default for the "Unknown" probe type is 1:1.

State Saved	Saved with probe calibration data. It survives power cycle and is not affected by Preset or Restore.
Range	0.001 to 10000
Instrument S/W Revision	Prior to A.02.00

This is an alternate form of the SCPI that allows input as a power instead of a ratio.

Remote Command:	<code>[:SENSE] :CORRection:IQ:I Q:ATTenuation <rel_ampl></code> <code>[:SENSE] :CORRection:IQ:I Q:ATTenuation?</code>
Range:	-60 dB to +80 dB
Example:	Set the attenuation for the current I probe type to 100.00:1. <code>CORR:IQ:I:ATT 20 dB</code>
Instrument S/W Revision:	Prior to A.02.00

Offset

Some active probes have DC offset capability. When one of these probes is connected this control will be visible. The signal is will be adjusted for the DC offset before entering the analyzer's port. This allows for removal of a DC offset before hitting the analyzer's input port voltage limits. For example, a signal that varies 1 V peak-to-peak with a DC offset equal to the analyzer's max input voltage would exceed the input limits of the analyzer for half its cycle. Removing the DC offset allows the analyzer to correctly process the entire signal.

Remote Command	<code>:INPut:OFFSet:I Q <voltage></code> <code>:INPut:OFFSet:I Q?</code>
Restriction and Notes	Only some probe types support Offset. For those that do, each probe type has its own Offset setting. As probes are changed the Offset value will reflect the new probe's setting. Changing the Offset affects only the current probe type's setting and leaves all others unchanged.
Example	Remove a DC offset of -0.5 V from the I channel input. <code>INP:OFFS:I -0.5</code>
Key Path	Input/Output, I/Q, I Setup Q Setup, I Probe Q Probe
Preset	0 V
State Saved	Saved with probe calibration data. It survives power cycle and is not affected by Preset or Restore.
Range	-18 V to +18 V
Instrument S/W Revision	Prior to A.02.00

Input/Output

Coupling

Some probe types allow coupling to reject low frequencies. This will filter out the DC component of a signal that is composed of a DC bias plus some AC signal. This control is visible only for probe types that have this capability.

Remote Command	:INPut:COUPling:I Q DC LFR1 LFR2 :INPut:COUPling:I Q?
Restriction and Notes	Only some probe types support Coupling. For those that do, each probe type has its own Coupling setting. As probes are changed the Coupling value will reflect the new probe's setting. Changing the Coupling affects only the current probe type's setting and leaves all others unchanged.
Example	Set the probe to low frequency rejection below 1.7 Hz. INP:COUP:I LFR1
Key Path	Input/Output, I/Q, I Setup Q Setup, I Probe Q Probe
Preset	DC
State Saved	Saved with probe calibration data. It survives power cycle and is not affected by Preset or Restore.
Range	DC AC 1.7 Hz LFR1 AC 0.14 Hz LFR2
Readback Text	DC LFR1 LFR2
Instrument S/W Revision	Prior to A.02.00

DC

Turns off low frequency rejection, allowing signals down to DC.

Example	Turn off low frequency rejection on the I channel INP:COUP:I DC
Key Path	Input/Output, I/Q, I Setup Q Setup, I Probe Q Probe, Coupling
Instrument S/W Revision	Prior to A.02.00

LFR1

Turns on low frequency rejection, rejecting signal component lower than 1.7 Hz.

Example	Turn on low frequency rejection on the I channel for frequencies lower than 1.7 Hz INP:COUP:I LFR1
Key Path	Input/Output, I/Q, I Setup Q Setup, I Probe Q Probe, Coupling
Instrument S/W Revision	Prior to A.02.00

LFR2

Turns on low frequency rejection, rejecting signal component lower than 0.14 Hz.

Example	Turn on low frequency rejection on the I channel for frequencies lower than 0.14 Hz INP:COUP:I LFR2
Key Path	Input/Output, I/Q, I Setup Q Setup, I Probe Q Probe, Coupling
Instrument S/W Revision	Prior to A.02.00

Calibrate

Starts the guided probe calibration. The guided probe calibration is context sensitive and depends on the channel (I or Q) and the Differential Input state. The calibration is only performed on the selected channel. When Differential Input is on, both the probe attached to the main port and the probe attached to the complementary port are calibrated. When Differential Input is off, only the probe attached to the main port is calibrated. See [“I/Q Guided Calibration” on page 516](#).

Key Path	Input/Output, I/Q, I Setup Q Setup, I Probe Q Probe, Coupling
Readback Text	The last calibration date, or if no calibration exists, "(empty)". Last: <cal date> <cal time> Example: Last: 8/22/2007 1:02:49 PM
Instrument S/W Revision	Prior to A.02.00

Clear Calibration

Clears the calibration data for the current port and probe. It does not clear the data for other probe types or other ports. If the sensed probe has EEPROM identification, only the data for that specific probe is cleared. After this command has completed, the probe calibration state will be the same as if no probe calibration had ever been performed for the specified channel and probe; the probe attenuation will be the default value for that probe type and the Cable Calibration frequency response corrections will be used. This command is dependent on the Differential Input state. When Differential Input is on, both the data for the probe attached to the main port and the data for the probe attached to the complementary port are cleared. When Differential Input is off, only data for the probe attached to the main port is cleared.

Remote Command	:CALibration:IQ:PROBe:I Q:CLEAr
Example	Clear the calibration data for the I channel and the current probe (with EEPROM identification) or probe type (without EEPROM identification). :CAL:IQ:PROBe:I:CLE
Key Path	Input/Output, I/Q, I Setup Q Setup, I Probe Q Probe

Input/Output

Instrument S/W Revision Prior to A.02.00

Reference Z

Sets the value of the impedance to be used in converting voltage to power for the I and Q channels. This does not change the hardware's path impedance (see ["I Input Z" on page 479](#)).

Remote Command :INPut:IMPedance:REFErence <integer>
 :INPut:IMPedance:REFErence?

Example Set the I/Q reference impedance to 50 Ω
 INP:IMP:REF 50

Key Path **Input/Output, I/Q**

Preset 50 Ω

State Saved Yes

This is unaffected by Preset but is set to the default value on a "Restore Input/Output Defaults" or "Restore System Defaults->All"

Range 1 Ω to 1 M Ω

Instrument S/W Revision Prior to A.02.00

RF Calibrator

Lets you choose a calibrator signal to look at or turns the calibrator "off" (meaning switches back to the selected input). When one of the calibrator signals is selected, the analyzer routes that signal (an internal amplitude reference) to the analyzer, while leaving the main input selection menu (RF or I/Q) unchanged.

This function presets to OFF on a Mode Preset, which causes the internal circuitry to switch back to the selected input (RF, Ext Mix or I/Q).

Remote Command: [:SENSE]:FEED:AREFErence REF50|REF4800|COMB|OFF
 [:SENSE]:FEED:AREFErence?

Example: FEED:AREF REF50 selects the 50 MHz amplitude reference as the signal input.
 FEED:AREF REF4800 selects the 4.8 GHz amplitude reference as the signal input
 FEED:AREF COMB selects the 300 MHz comb modulated signal as the signal input
 FEED:AREF OFF turns the calibrator "off" (meaning switches back to the selected input – RF, ExtMix or I/Q)

Dependencies/Couplings:	Selecting an input (RF, Ext Mix or I/Q) turns the Calibrator OFF. This is true whether the input is selected by the keys or with the [:SENSe]:FEED command. The 4.8 GHz internal reference is only available in some models, and only with options 507, 508, 513, and 526.
Preset:	OFF
State Saved:	Saved in State
Key Path:	Input/Output
Readback:	Off, 50 MHz, 4.8 GHz or Comb
Instrument S/W Revision:	Prior to A.02.00

50 MHz

Selects the 50 MHz internal reference as the input signal.

Key Path	Input/Output, RF Calibrator
Readback	50 MHz
Instrument S/W Revision	Prior to A.02.00

4.8 GHz

Selects the 4.8 GHz internal reference as the input signal.

Dependencies/Couplings:	This key is blank (unavailable) in MXA with frequency option 503, and in EXA
Key Path:	Input/Output, RF Calibrator
Readback:	4.8 GHz
Instrument S/W Revision:	Prior to A.02.00

Comb

Selects the 300 MHz comb modulated signal as the input signal.

Key Path	Input/Output, RF Calibrator
Readback	Comb
Instrument S/W Revision	Prior to A.02.00

Off

Switches the input back to the selected input (RF, Ext Mix or I/Q)

Key Path	Input/Output, RF Calibrator
----------	------------------------------------

Input/Output

Readback	Off
Instrument S/W Revision	Prior to A.02.00

External Gain

Compensates for gain/loss in the measurement system outside the spectrum analyzer. The External Gain is subtracted from the amplitude readout (or the loss is added to the amplitude readout). So, the displayed signal level represents the signal level at the output of the device-under-test, which can be the input of an external device that provides gain/loss.

Entering an External Gain value does not affect the Reference Level, therefore the trace position on screen changes, as do all of values represented by the trace data. Thus, the values of exported trace data, queried trace data, marker amplitudes, trace data used in calculations such as N dB points, trace math, peak threshold, etc., are all affected by External Gain. Changing the External Gain, even on a trace which is not updating, will immediately change all of the above, without new data needing to be taken.

NOTE	Changing the External Gain causes the analyzer to immediately stop the current sweep and prepare to begin a new sweep, but the data will not change until the trace data updates, because the offset is applied to the data as it is taken. If a trace is exported with a nonzero External Gain, the exported data will contain the trace data with the offset applied.
-------------	---

In the Spectrum Analyzer mode, a Preamp is the common external device providing gain/loss. In a measurement application mode like GSM or W-CDMA, the gain/loss could be from a BTS (Base Transceiver Station) or an MS (Mobile Station). So in the Spectrum Analyzer mode MS and BTS would be grayed out and the only choice would be Ext Preamp. Similarly in some of the digital communications applications, Ext Preamp will be grayed out and you would have a choice of MS or BTS.

Dependencies/Couplings:	The Ext Preamp, MS, and BS keys may be grayed out depending on which measurement is currently selected. If any of the grayed out keys are pressed, or the equivalent SCPI command is sent, an advisory message is generated.
Key Path:	Input/Output
Readback:	1-of-N selection [variable]
Instrument S/W Revision:	Prior to A.02.00

Ext Preamp

This function is similar to the reference level offset function. Both affect the displayed signal level. Ref Lvl Offset is a mathematical offset only, no analyzer configuration is affected. Ext Preamp gain is used when determining the auto-coupled value of the Attenuator. The External Gain value and the Maximum Mixer Level settings are both part of the automatic setting equation for the RF attenuation setting. (10 dB of Attenuation is added for every 10 dB of External Gain.)

Please note that the Ref Lvl Offset and Maximum Mixer Level are described in the Amplitude section. They are reset by the instrument Preset. The External Preamp Gain is reset by the "Restore Input/Output Defaults" or "Restore System Defaults->All functions. The External Gain is subtracted from the

amplitude readout so that the displayed signal level represents the signal level at the output of the device-under-test, which is the input of the external device that is providing gain/loss.

Remote Command:	<code>[:SENSE] :CORRection:SA [:RF] :GAIN <rel_ampl></code> <code>[:SENSE] :CORRection:SA [:RF] :GAIN?</code>
Example:	<code>CORR:SA:GAIN 10</code> sets the Ext Gain value to 10 dB <code>CORR:SA:GAIN -10</code> sets the Ext Gain value to -10 dB (that is, an attenuation of 10 dB)
Dependencies/Couplings:	The reference level limits are determined in part by the External Gain/Atten, Max Mixer Level, and RF Atten. This key is grayed out in many application Modes.
Preset:	This is unaffected by Preset but is set to 0 dB on a "Restore Input/Output Defaults" or "Restore System Defaults->All"
State Saved:	Saved in State
Min:	-81.90 dB
Max:	81.90 dB
Key Path:	Input/Output, External Gain
Readback:	Preamp Gain, <Ext Gain value> dB
Instrument S/W Revision:	Prior to A.02.00

MS

Sets an external gain/attenuation value for MS (Mobile Station) tests.

Remote Command:	<code>[:SENSE] :CORRection:MS [:RF] :GAIN <rel_ampl></code> <code>[:SENSE] :CORRection:MS [:RF] :GAIN?</code>
Example:	<code>CORR:MS:GAIN 10</code> sets the Ext Gain value to 10 dB <code>CORR:MS:GAIN -10</code> sets the Ext Gain value to -10 dB (that is, a loss of 10 dB.)
Dependencies/Couplings:	The reference level limits are determined in part by the External Gain, Max Mixer Level, RF Atten This key is grayed out in the SA Mode.
Preset:	This is unaffected by Preset but is set to 0 dB on a "Restore Input/Output Defaults" or "Restore System Defaults->All"
State Saved:	Saved in State
Min:	-100 dB
Max:	100 dB
Key Path:	Input/Output, External Gain

Input/Output

Readback: MS, <Ext Gain value> dB

Instrument S/W Revision: Prior to A.02.00

BTS

Sets an external attenuation value for BTS (Base Transceiver Station) tests.

Remote Command: [:SENSe]:CORRection:BTS[:RF]:GAIN <rel_ampl>
[:SENSe]:CORRection:BTS[:RF]:GAIN?

Example: CORR:BTS:GAIN 10 sets the Ext Gain value to 10 dB
CORR:BTS:GAIN -10 sets the Ext Gain value to -10 dB (that is, a loss of 10 dB.)

Dependencies/Couplings: The reference level limits are determined in part by the External Gain, Max Mixer Level, RF Atten

This key is grayed out in the SA Mode.

Preset: This is unaffected by Preset but is set to 0 dB on a "Restore Input/Output Defaults" or "Restore System Defaults->All"

State Saved: Saved in State

Min: -100 dB

Max: 100 dB

Key Path: **Input/Output, External Gain**

Readback: BTS, <Ext Gain value> dB

Instrument S/W Revision: Prior to A.02.00

I Ext Gain

This function affects only the I channel input, except when the Input Path is I+jQ. In I+jQ this setting is applied to both I and Q channel inputs. It is not available unless the Baseband I/Q option (BBA) is installed.

Remote Command [:SENSe]:CORRection:IQ:I:GAIN <rel_ampl>
[:SENSe]:CORRection:IQ:I:GAIN?

Restriction and Notes Not available unless option BBA is installed

Example Set the I Ext Gain to 10 dB
CORR:IQ:I:GAIN 10
Set the I Ext Gain to -10 dB (that is, a loss of 10 dB.)
CORR:IQ:I:GAIN -10

Key Path **Input/Output, External Gain**

Preset	0 dB
	This is unaffected by Preset but is set to 0 dB on a "Restore Input/Output Defaults" or "Restore System Defaults->All"
State Saved	Saved in instrument state.
Min	-100 dB
Max	100 dB
Readback Text	I Gain, <I Ext Gain> dB
Instrument S/W Revision	Prior to A.02.00

Q Ext Gain

This function affects only the Q channel input and only when the Input Path is not I+jQ. It is not available unless the Baseband I/Q option (BBA) is installed.

Remote Command	<code>[:SENSE] :CORRection:IQ:Q:GAIN <rel_ampl></code> <code>[:SENSE] :CORRection:IQ:Q:GAIN?</code>
Restriction and Notes	Not available unless option BBA is installed
Example	Set the Q Ext Gain to 10 dB <code>CORR:IQ:Q:GAIN 10</code> Set the Q Ext Gain to -10 dB (that is, a loss of 10 dB.) <code>CORR:IQ:Q:GAIN -10</code>
Key Path	Input/Output, External Gain
Preset	0 dB
	This is unaffected by Preset but is set to 0 dB on a "Restore Input/Output Defaults" or "Restore System Defaults->All"
State Saved	Saved in instrument state.
Min	-100 dB
Max	100 dB
Readback Text	Q Gain, <I Ext Gain> dB
Instrument S/W Revision	Prior to A.02.00

Restore Input/Output Defaults

This selection causes the group of settings and data associated with **Input/Output** key to be a reset to their default values. This level of Restore System Defaults does not affect any other system settings or mode settings and does not cause a mode switch. All the features described in this section are reset using this key, including Input Corrections and Data (described in the Corrections section).

Example:	:SYST:DEF INP presets all the Input/Output variables to their factory default values.
Remote Command Notes:	Please refer to the Utility Functions for information about Restore System Defaults and the complete description of the :SYSTem:DEFAult INPut: command.
Key Path:	Input/Output
Instrument S/W Revision:	Prior to A.02.00

Data Source

Gives you the choice of either using a hardware input signal as the input or raw data stored in a data storage buffer from an earlier acquisition. You can also share raw data across certain measurements that support this feature. The measurements must be capable of storing raw data. There are three choices under this menu. You can select "Inputs" which is the same as selecting one of the inputs from the input port, for example RF, AREF, I/Q, EXTMixer, or IFALign. Selecting "Capture Buffer" allows you to use data that has been stored earlier in the same measurement or from a previous measurement using the "Current Meas -> Capture Buffer" feature. Selecting "Recorded Data" allows you to playback long data capture records stored in the record buffer.

When you make a recording (see **Record Data Now** below) or when you recall a recording (see the Recall section) the data source is automatically set to Recorded Data. You can toggle the data source between Inputs and the current Recording (if there is one). That is, the recording remains in memory until it is replaced by a new recording, or the application is closed.

Remote Command:	[:SENSE] :FEED:DATA INPut STORed RECorded [:SENSE] :FEED:DATA?
Example:	FEED:DATA REC FEED:DATA?
Dependencies/Couplings:	Not all inputs are available in all modes. Unavailable keys are grayed out.
Remote Command Notes:	INPut = Inputs STORed = Capture Buffer RECorded = Record Data Buffer
Preset:	This is unaffected by Preset but is set to INPut on a "Restore Input/Output Defaults" or "Restore System Defaults->All"
State Saved:	Saved in state
Key Path:	Input/Output

Readback: Variable
 Instrument S/W Revision: Prior to A.02.00

Inputs

Sets the measurement to use the input selections (RF, AREF, EXTMix, I/Q)

Example: FEED:DATA INP causes the measurement to look at the input selection

Key Path: **Input/Output, Data Source**

Readback: Inputs

Instrument S/W Revision: Prior to A.02.00

Capture Buffer

Some WCDMA and demod measurements support this feature. This allows sharing of the raw data across certain measurements. If you want to make another measurement on the same signal, you would store that raw data using the "Current Meas -> Capture Buffer" key. Then the data is available for the next measurement to use. You must have raw data stored in the instrument memory before the Capture Buffer choice is available for use.

If you switch to a measurement that does not support this feature, then the instrument switches to use "Inputs" and grays out this key. If the grayed out key is pressed, it generates a message.

Example: FEED:DATA STOR causes stored measurement data to be used with a different measurement that supports this.

Dependencies/Couplings: Grayed out in the SA measurement.

Key Path: **Input/Output, Data Source**

Readback: Stored Data

Instrument S/W Revision: Prior to A.02.00

Recorded Data

Directs the instrument to get data from the record data buffer in the measurement, rather than from the RF Input Signal.

Example: FEED:DATA REC causes the measurement to extract data from the record data buffer

Dependencies/Couplings: Grayed out in the SA measurement.

Key Path: **Input/Output, Data Source**

Readback: Recorded Data

Instrument S/W Revision: Prior to A.02.00

Input/Output

Current Meas -> Capture Buffer

Pressing this key stores the raw data of one measurement in the internal memory of the instrument where it can then be used by a different measurement by pressing "Stored Data". When raw data is stored, then data source selection switch automatically changes to "Stored Data". Stored raw data cannot be directly accessed by a user. There is no save/recall function to save the raw data in an external media. However if you want to get the stored raw data, you must first perform a measurement using the stored raw data. Now you can access the used raw data, which is the same as stored raw data, using the FETCh or READ commands.

Remote Command:	[:SENSE] :FEED:DATA:STORe
Example:	FEED:DATA:STOR stores recorded data
Dependencies/Couplings:	Grayed out in the SA measurement.
Remote Command Notes:	This is command only, there is no query
Key Path:	Input/Output, Data Source
Instrument S/W Revision:	Prior to A.02.00

Record Data Now

This causes the data source to change to Inputs (if it is not already set) and a recording is made with the current instrument setup. The length of the recording must be specified in advance.

This key changes to **Abort Recording** once the recording process has started. It changes back when the recording is complete.

The following dialogs show the progress of the recording:

This key is also available in the Sweep/Control menu.

Remote Command	[:SENSE] :RECORDing:INITiate [:IMMediate]
Example	REC:INIT
Dependencies/Couplings	Changes Data source to Recorded Data. Grayed out in the SA measurement.
Remote Command Notes	This is command only, there is no query. See the Recall functionality to access previously saved data.
Key Path	Input/Output, Data Source
Mode	VSA
Instrument S/W Revision	Prior to A.02.00

Remote Command:	[:SENSE] :RECORDing:ABORT
Example:	REC:ABOR
Key Path:	Input/Output, Data Source

Remote Command Notes: This is command only, there is no query. The command does nothing if it is sent when there is no recording in progress.

Instrument S/W Revision: Prior to A.02.00

Record Length

This specifies the length of the next recording. (You cannot use this to modify the length of the current recording.) The length defaults to seconds, but you can also specify it in points at the current sample rate, or in time records at the current time record length.

Remote Command [:SENSe]:RECOrding:LENGth <real>,SECOnds|RECOrds|POINts
[:SENSe]:RECOrding:LENGth:STATe MAX|MANual
[:SENSe]:RECOrding:LENGth:STATe?

Example REC:LENG 20,REC
REC:LENG 4.1E-4,SEC
REC:LENG:STAT MAX
REC:LENG:STAT?

Remote Command Notes There is no default unit. The unit must be specified.
The length command does not have a query form. Length information is queried using the two commands following this table.
If set to MAX, all of the available "recording memory" is used.

Key Path **Input/Output, Data Source**
Mode VSA
Preset 50 Records, Manual
State Saved No
Min 0
Max Depends on memory available
Readback <value><Seconds|Points|Records>
Instrument S/W Revision Prior to A.02.00

Remote Command [:SENSe]:RECOrding:LENGth:VALue?

Example REC:LENG:VAL?

Remote Command Notes Query Only
Returns the first (numeric) parameter of the most recent [:SENSe]:RECOrding:LENGth command.

Mode VSA

Input/Output

Preset	50 Records
Instrument S/W Revision	Prior to A.02.00
Remote Command	<code>[:SENSe] :RECOrding:LENGth:UNIT?</code>
Example	<code>REC:LENG:UNIT?</code>
Remote Command Notes	Query Only Returns the second parameter of the most recent <code>[:SENSe] :RECOrding:LENGth</code> command. Possible values are <code>SEC REC POIN</code> . If no second parameter was sent, then the return value is <code>SEC</code> .
Mode	VSA
Preset	RECOrcs
Instrument S/W Revision	Prior to A.02.00

Corrections

This key accesses the Amplitude Corrections menu.

Amplitude Corrections arrays can be entered by you, sent over SCPI, or loaded from a file. They allow a user to correct the response of the analyzer for various use cases. The X-series supports four separate Corrections arrays, each of which can contain up to 2000 points. They can be turned on and off individually and any or all can be on at the same time.

Trace data is in absolute units and corrections data is in relative units, but we want to be able to display trace data at the same time as corrections data. Therefore we establish a reference line to be used while building or editing a Corrections table. The reference line is halfway up the display and represents 0 dB of correction. It is labeled "0 dB CORREC". It is drawn in blue (0,0,255) and is three pixels high.

Corrections data is always in dB. Whatever dB value appears in the correction table represents the correction to be applied to that trace at that frequency. So if a table entry shows 30 dB that means we ADD 30 dB to each trace to correct it before displaying it.

In zero span, where the frequency is always the center frequency of the analyzer, we apply the (interpolated) correction for the center frequency to all points in the trace. In the event where there are two correction amplitudes at the center frequency, we apply the first one in the table.

Note that the corrections are applied as the data is taken; therefore, a trace in **View** (Update Off) will not be affected by changes made to the corrections table after the trace is put in **View**.

Key Path	Input/Output, Corrections
Mode	SA, DVB-T/H, DTMB
Measurement	Swept SA
Preset	Corrections arrays are reset (deleted) by Restore Input/Output Defaults. They survive shutdown and restarting of the analyzer application, which means they will survive a power cycle.

Dependencies/Couplings	Amplitude correction may not be available in all modes; if a mode does not support amplitude correction, the Corrections key should be blanked while in that mode. If an application supports corrections but the current measurement does not, then the key should be grayed out in that measurement
Instrument S/W Revision	A.02.00

Select Correction

Specifies the selected correction. The term "selected correction" is used throughout this document to specify which correction will be affected by the functions.

Key Path	Input/Output, Corrections
Mode	SA
Preset	Set to Correction 1 by Restore Input/Output Defaults
Readback	Correction 1 Correction 2 Correction 3 Correction 4
Instrument S/W Revision	A.02.00

Correction On/Off

Turning the Selected Correction on allows the values in it to be applied to the data. This also automatically turns on "Apply Corrections" (sets it to ON), otherwise the correction would not take effect.

A new sweep is initiated if an amplitude correction is switched on or off. Note that changing, sending or loading corrections data does NOT directly initiate a sweep, however in general these operations will turn corrections on, which DOES initiate a sweep.

Remote Command: `[:SENSE] :CORRection:CSET [1 | 2 | 3 | 4 [:STATe] ON | OFF | 1 | 0`
`[:SENSE] :CORRection:CSET [1 | 2 | 3 | 4 [:STATe] ?`

Example: `SENS:CORR:CSET1 ON`

Dependencies/Couplings: Turning this on automatically turns on "Apply Corrections"

Only the first correction array (Correction 1) supports antenna units. When this array is turned on, and it contains an Antenna Unit other than "None", the Y Axis Unit of the analyzer is forced to that Antenna Unit. All other Y Axis Unit choices are grayed out.

Note that this means that a correction file with an Antenna Unit can only be loaded into the Corrections 1 register. Consequently only for Correction 1 does the dropdown in the Recall dialog include .ant, and if an attempt is made to load a correction file into any other Correction register which DOES contain an antenna unit, a Mass Storage error is generated.

Preset: Not affected by Preset. Set to OFF by **Restore Input/Output Defaults**

State Saved: Saved in State

Input/Output

Key Path: **Input/Output, Corrections**
Instrument S/W Revision: A.02.00

Properties

Accesses a menu that lets you set the properties of the selected correction.

Key Path **Input/Output, Corrections**
Instrument S/W Revision A.02.00

Select Correction

Specifies the selected correction. The term "selected correction" is used throughout this document to specify which correction will be affected by the functions.

Key Path **Input/Output, Corrections, Properties**
Preset Set to Correction 1 by Restore Input/Output Defaults
Readback Correction 1|Correction 2|Correction 3|Correction 4
Instrument S/W Revision A.02.00

Antenna Unit

For devices (like antennae) which make measurements of field strength or flux density, the correction array should contain within its values the appropriate conversion factors such that, when the data on the analyzer is presented in dB μ V, the display is calibrated in the appropriate units. The "Antenna Unit" used for the conversion is contained within the corrections array database. It may be specified by you or loaded in from an external file or SCPI.

When an array with an Antenna Unit other than "None" is turned on, the Y Axis Unit of the analyzer is forced to that unit. When this array is turned on, and it contains an Antenna Unit other than "None", the Y Axis Unit of the analyzer is forced to that Antenna Unit., and all other Y Axis Unit choices are grayed out.

Antenna Unit does not appear in all Modes that support Corrections. Only the modes listed in the Mode row of the table below support Antenna Units.

Remote Command `[:SENSe] :CORRection:CSET [1] | 2 | 3 | 4 :ANTenna [:UNIT]
GAUSS | PTES1a | UVM | UAM | NOConversion`
`[:SENSe] :CORRection:CSET [1] | 2 | 3 | 4 :ANTenna [:UNIT] ?`

Example `CORR:CSET:ANT GAUS`

Dependencies/Couplings	Only the first correction array (Correction 1) supports antenna units. Note that this means that a correction file with an Antenna Unit can only be loaded into the Corrections 1 register. Consequently only for Correction 1 does the dropdown in the Recall dialog include .ant, and if an attempt is made to load a correction file into any other Correction register which DOES contain an antenna unit, a Mass Storage error is generated.
Key Path	Input/Output, Corrections, Properties
Mode	SA
Preset	Unaffected by Preset. Set to NOC by Restore Input/Output Defaults
State Saved	Saved in State
Instrument S/W Revision	A.02.00

dB μ V/m

Sets the antenna unit to dB μ V/m. If this correction is turned on, and Apply Corrections is on, the Y Axis Unit will then be forced to dB μ V/m and all other Y Axis Unit selections will be grayed out.

Example:	:CORR:CSET2:ANT UVM
Key Path:	Input/Output, Corrections, Properties, Antenna Unit
Readback:	"dB μ V/m"
Instrument S/W Revision:	A.02.00

dB μ A/m

Sets the antenna unit to dB μ A/m. If this correction is turned on, and Apply Corrections is on, the Y Axis Unit will then be forced to dB μ A/m and all other Y Axis Unit selections will be grayed out.

Example:	:CORR:CSET2:ANT UVA
Key Path:	Input/Output, Corrections, Properties, Antenna Unit
Readback:	" dB μ A/m"
Instrument S/W Revision:	A.02.00

dBpT

Sets the antenna unit to dBpT. If this correction is turned on, and Apply Corrections is on, the Y Axis Unit will then be forced to dBpT and all other Y Axis Unit selections will be grayed out.

Example:	:CORR:CSET3:ANT PTES
Key Path:	Input/Output, Corrections, Properties, Antenna Unit
Readback:	"dBpT"
Instrument S/W Revision:	A.02.00

Input/Output

dBG

Sets the antenna unit to dBG. If this correction is turned on, and Apply Corrections is on, the Y Axis Unit will then be forced to dBG and all other Y Axis Unit selections will be grayed out.

Example: :CORR:CSET:ANT GAUS
Key Path: **Input/Output, Corrections, Properties, Antenna Unit**
Readback: " dBG"
Instrument S/W Revision: A.02.00

None

Selects no antenna unit for this Correction set. Thus no Y Axis unit will be forced.

Example: :CORR:CSET4:ANT NOC
Key Path: **Input/Output, Corrections, Properties, Antenna Unit**
Readback: "None"
Instrument S/W Revision: A.02.00

Frequency Interpolation

This setting controls how the correction values per-bucket are calculated. We interpolate between frequencies in either the logarithmic or linear scale.

This setting is handled and stored individually per correction set.

Remote Command: [:SENSE]:CORRection:CSET [1] | 2 | 3 | 4 :X:SPACing
LINear | LOGarithmic
[:SENSE]:CORRection:CSET [1] | 2 | 3 | 4 :X:SPACing?
Example: CORR:CSET:X:SPAC LIN
Preset: Unaffected by Preset. Set to Linear by Restore Input/Output Defaults
State Saved: Saved in State
Key Path: **Input/Output, Corrections, Properties**
Instrument S/W Revision: A.02.00

Description

Sets an ASCII description field which will be stored in an exported file. Can be displayed in the active function area by selecting as the active function, if desired to be in a screen dump.

Remote Command: [:SENSE]:CORRection:CSET [1] | 2 | 3 | 4 :DESCRiption "text"
[:SENSE]:CORRection:CSET [1] | 2 | 3 | 4 :DESCRiption?
Example: :CORR:CSET1:DESC "11941A Antenna correction"

Remote Command Notes:	45 chars max; may not fit on display if max chars used
Preset:	Unaffected by Preset. Set to empty by Restore Input/Output Defaults
State Saved:	Saved in State
Key Path:	Input/Output, Corrections, Properties
Instrument S/W Revision:	A.02.00

Comment

Sets an ASCII comment field which will be stored in an exported file. Can be displayed in the active function area by selecting as the active function, if desired to be in a screen dump.

Remote Command:	<code>[:SENSE] :CORRection:CSET [1] 2 3 4 :COMMeNt "text "</code> <code>[:SENSE] :CORRection:CSET [1] 2 3 4 :COMMeNt ?</code>
Example:	<code>:CORR:CSET1:COMM "this is a comment"</code>
Remote Command Notes:	45 chars max; may not fit on display if max chars used
Preset:	Unaffected by Preset. Set to empty by Restore Input/Output Defaults
State Saved:	Saved in State
Key Path:	Input/Output, Corrections, Properties
Instrument S/W Revision:	A.02.00

Edit

Invokes the integrated editing facility for this correction set.

When entering the menu, the editor window turns on, the selected correction is turned **On**, **Apply Corrections** is set to **On**, the amplitude scale is set to **Log**, and the Amplitude Correction (“Ampcor”) trace is displayed. The actual, interpolated correction trace is shown in green for the selected correction. Note that since the actual interpolated correction is shown, the correction trace may have some curvature to it. This trace represents only the correction currently being edited, rather than the total, accumulated amplitude correction for all amplitude corrections which are currently on, although the total, accumulated correction for all corrections which are turned on is still applied to the data traces.

Because corrections data is always in dB, but the Y-axis of the analyzer is in absolute units, it is necessary to establish a reference line for display of the Corrections data. The reference line is halfway up the display and represents 0 dB of correction. It is labeled “0 dB CORREC”. It is drawn in blue.

Corrections data is always in dB. Whatever dB value appears in the correction table represents the correction to be applied to that trace at that frequency. So if a table entry shows 30 dB that means we ADD 30 dB to each trace to correct it before displaying it. By definition all points are connected. If a gap is desired for corrections data, enter 0 dB.

Note that a well-designed Corrections array should start at 0 dB and end at 0 dB. This is because whatever the high end point is will be extended to the top frequency of the instrument, and whatever the low end point is will be extended down to 0 Hz. So for a Corrections array to have no effect outside its range, you should start and end the array at 0 dB.

Input/Output

NOTE The table editor will only operate properly if the analyzer is sweeping, because its updates are tied to the sweep system. Thus, you should not try to use the editor in single sweep, and it will be sluggish during compute-intensive operations like narrow-span FFT sweeps.

When exiting the edit menu (by using the **Return** key or by pressing an instrument front-panel key), the editor window turns off and the Ampcor trace is no longer displayed; however, **Apply Corrections** remains **On**, any correction that was on while in the editor remains on, and the amplitude scale returns to its previous setting.

Corrections arrays are not affected by Preset, because they are in the Input/Output system. They also survive shutdown and restarting of the analyzer application, which means they will survive a power cycle.

Key Path	Input/Output, Corrections
Instrument S/W Revision	A.02.00

Navigate

Lets you move through the table to edit the desired point

Key Path	Input/Output, Corrections, Edit
Notes	There is no value readback on the key
Instrument S/W Revision	A.02.00

Frequency

Lets you edit the frequency of the current row.

Key Path	Input/Output, Corrections, Edit
Notes	There is no value readback on the key
Instrument S/W Revision	A.02.00

Amplitude

Lets you edit the Amplitude of the current row.

Key Path	Input/Output, Corrections, Edit
Notes	There is no value readback on the key
Instrument S/W Revision	A.02.00

Insert Point Below

Pressing this key inserts a point below the current point. The new point is a copy of the current point. And becomes the current point. The new point is not yet entered into the underlying table, and the data in the row is displayed in Light Gray.

Key Path	Input/Output, Corrections, Edit
Instrument S/W Revision	A.02.00

Delete Point

This is an immediate action key. It will immediately delete the currently-selected point, whether or not that point is being edited, and select Navigate. The point following the currently-selected point (or the point preceding if there is none) will be selected.

Key Path	Input/Output, Corrections, Edit
Instrument S/W Revision	A.02.00

Scale X Axis

Matches the X Axis to the selected Correction, as well as possible. Sets the Start and Stop Frequency to contain the minimum and maximum Frequency of the selected Correction. The range between Start Frequency and Stop Frequency is 12.5% above the range between the minimum and maximum Frequency so that span exceeds this range by one graticule division on either side. If in zero-span, or there is no data in the Ampcor table, or the frequency range represented by the table is zero, no action is taken. Standard clipping rules apply, if the value in the table is outside the allowable range for the X axis.

Key Path	Input/Output, Corrections, Edit
Instrument S/W Revision	A.02.00

Delete Correction

Deletes the correction values for this set. When this key is pressed a prompt is placed on the screen that says "Please press Enter or OK key to delete correction. Press ESC or Cancel to close this dialog." The deletion is only performed if you press OK or Enter; if so, after the deletion, the informational message "Correction deleted" appears in the MSG line.

Remote Command:	[:SENSe] :CORRection:CSET [1] 2 3 4 :DELete
Example:	CORR:CSET:DEL CORR:CSET1:DEL CORR:CSET4:DEL
Key Path:	Input/Output, Corrections
Instrument S/W Revision:	A.02.00

Input/Output

Apply Corrections

Applies amplitude corrections which are marked as ON to the measured data. If this is set to NO, then no amplitude correction sets will be used, regardless of their individual on/off settings. If set to YES, then the corrections that are marked as ON (see “Correction On/Off” on page 499) will be used.

Remote Command: `[:SENSE] :CORRection:CSET:ALL [:STATE] ON | OFF | 1 | 0`
`[:SENSe] :CORRection:CSET:ALL [:STATE] ?`

Example: `SENS:CORR:CSET:ALL OFF`

This command makes sure that no amplitude corrections are applied, regardless of their individual on/off settings.

Preset: Not affected by Preset. Set to OFF by Restore Input/Output Defaults

State Saved: Saved in state

Key Path: **Input/Output, Corrections**

Instrument S/W Revision: A.02.00

Delete All Corrections

Erases all correction values for all 4 Amplitude Correction sets.

When this key is pressed a prompt is placed on the screen that says “Please press Enter or OK key to delete all corrections. Press ESC or Cancel to close this dialog.” The deletion is only performed if you press OK or Enter; if so, after the deletion, the informational message “All Corrections deleted” appears in the MSG line.

Remote Command: `[:SENSe] :CORRection:CSET:ALL:DELeTe`

Example: `CORR:CSET:ALL:DEL`

Key Path: **Input/Output, Corrections**

Instrument S/W Revision: A.02.00

Remote Correction Data Set Commands

Set (Replace) Data (Remote Command Only)

The command takes an ASCII series of alternating frequency and amplitude points, each value separated by commas.

The values sent in the command will totally replace all existing correction points in the specified set.

An Ampcor array can contain 2000 points maximum.

Remote Command: `[:SENSe] :CORRection:CSET [1] | 2 | 3 | 4 :DATA <freq>, <ampl>, .`
`. .`
`[:SENSe] :CORRection:CSET [1] | 2 | 3 | 4 :DATA?`

Example:	<code>CORR:CSET1:DATA 10000000,-1.0,20000000,1.0</code> This defines two correction points at (10 MHz, -1.0 dB) and (20 MHz, 1.0 dB) for correction set 1.
Preset:	Empty after Restore Input/Output Defaults. Survives shutdown/restart of analyzer application (including power cycle)
State Saved:	Saved in state
Min:	Freq: 0 Hz Amptd: -1000 dBm
Max:	Freq: 1 THz Amptd: +1000 dBm
Instrument S/W Revision:	A.02.00

Merge Correction Data (Remote Command Only)

The command takes an ASCII series of alternating frequency and amplitude points, each value separated by commas. The difference between this command and Set Data is that this merges new correction points into an existing set.

Any new point with the same frequency as an existing correction point will replace the existing point's amplitude with that of the new point.

An Ampcor array can contain 2000 total points, maximum.

Remote Command:	<code>[:SENSE] :CORRection:CSET [1] 2 3 4 :DATA:MERGe <freq>, <ampl>, ...</code>
Example:	<code>CORR:CSET1:DATA:MERGE 15000000,-5.0,25000000,5.0</code> This adds two correction points at (15 MHz, -5.0 dB) and (25 MHz, 5.0 dB) to whatever values already exist in correction set 1.
Preset:	Empty after Restore Input/Output Defaults. Survives shutdown/restart of analyzer application (including power cycle)
Min:	Freq: 0 Hz Amptd: -1000 dBm
Max:	Freq: 1 THz Amptd: +1000 dBm
Instrument S/W Revision:	A.02.00

Freq Ref In

Specifies the frequency reference as being the internal reference, external reference or sensing the presence of an external reference.

When the frequency reference is set to internal, the internal 10 MHz reference is used even if an external reference is connected.

Input/Output

When the frequency reference is set to external, the instrument will use the external reference. However, if there is no external signal present, or it is not within the proper amplitude range, an error condition detected message is generated. When the external signal becomes valid, the error is cleared.

If Sense is selected, the instrument checks whether a signal is present at the external reference connector and will automatically switch to the external reference when a signal is detected. When no signal is present, it automatically switches to the internal reference. No message is generated as the reference switches between external and internal. The monitoring of the external reference occurs approximately on 1 millisecond intervals, and never occurs in the middle of a measurement acquisition, only at the end of the measurement (end of the request).

If for any reason the instrument's frequency reference is not able to obtain lock, Status bit 2 in the Questionable Frequency register will be true and an error condition detected message is generated. When lock is regained, Status bit 2 in the Questionable Frequency register will be cleared and an error message is cleared will be sent.

If an external frequency reference is being used, you must enter the frequency of the external reference if it is not exactly 10 MHz. The External Ref Freq key is provided for this purpose.

Remote Command:	<code>[:SENSE] :ROSCillator :SOURCE :TYPE INTERNAL EXTERNAL SENSE [:SENSE] :ROSCillator :SOURCE :TYPE?</code>
Preset:	This is unaffected by Preset but is set to SENSE on a "Restore Input/Output Defaults" or "Restore System Defaults->All".
State Saved:	Saved in State.
Key Path:	Input/Output
SCPI Status Bits/OPC Dependencies:	STATus:QUESTIONable:FREQUENCY bit 2 set if unlocked.
Instrument S/W Revision:	Prior to A.02.00
Remote Command:	<code>[:SENSE] :ROSCillator :SOURCE?</code>
Remote Command Notes:	The query [SENSE]:ROSCillator:SOURCE? returns the current switch setting. This means: <ol style="list-style-type: none">1. If it was set to SENSE but there is no external reference so the instrument is actually using the internal reference, then this query returns INTERNAL and not SENSE.2. If it was set to SENSE and there is an external reference present, the query returns EXTERNAL and not SENSE.3. If it was set to EXTERNAL, then the query returns "EXTERNAL"4. If it was set to INTERNAL, then the query returns INTERNAL
Preset:	SENSE
Instrument S/W Revision:	Prior to A.02.00

Remote Command: [:SENSe]:ROSCillator:SOURce INTernal|EXTernal
 Instrument S/W Revision: Prior to A.02.00

Sense

The external reference is used if a valid signal is sensed at the Ext Ref input. Otherwise the internal reference is used.

Example: :ROSC:SOUR:TYPE SENS
 Key Path: **Input/Output, Freq Ref In**
 Readback: Sense
 Instrument S/W Revision: Prior to A.02.00

Internal

The internal reference is used.

Example: :ROSC:SOUR:TYPE INT
 Key Path: **Input/Output, Freq Ref In**
 Readback: Internal
 Instrument S/W Revision: Prior to A.02.00

External

The external reference is used.

Example: :ROSC:SOUR:TYPE EXT
 Key Path: **Input/Output, Freq Ref In**
 Readback: External
 Instrument S/W Revision: Prior to A.02.00

Ext Ref Freq

This key tells the analyzer the frequency of the external reference. When the external reference is in use (either because the reference has been switched to External or because the Reference has been switched to Sense and there is a valid external reference present) this information is used by the analyzer to determine the internal settings needed to lock to that particular external reference signal.

For the instrument to stay locked, the value entered must be within 5 ppm of the actual external reference frequency. So it is important to get it close, or you risk an unlock condition.

Input/Output

This value only affects the instrument's ability to lock. It does not affect any calculations or measurement results. See "Freq Offset" in the Frequency section for information on how to offset frequency values.

Remote Command:	<code>[:SENSE] :ROSCillator:EXTernal:FREQuency <freq></code> <code>[:SENSE] :ROSCillator:EXTernal:FREQuency?</code>
Example:	ROSC:EXT:FREQ 20 MHz sets the external reference frequency to 20 MHz, but does not select the external reference. ROSC:SOUR:TYPE EXT selects the external reference.
Preset:	This is unaffected by Preset but is set to 10 MHz on a "Restore Input/Output Defaults" or "Restore System Defaults->All"
Min:	EXA: 10 MHz MXA: 1 MHz
Max:	EXA: 10 MHz MXA: 50 MHz
Key Path:	Input/Output, Freq Ref In
Default Unit:	Hz
Instrument S/W Revision:	Prior to A.02.00

External Ref Coupling

Only appears with option ERC installed and licensed.

This function lets you couple the sweep system of the analyzer to the state of the External Reference. If **Normal** is selected, data acquisition proceeds regardless of the state of the External Reference. When you select **Ext Ref Out Of Range Stops Acquisition**, the data acquisition (sweep or measurement) stops when either the "521, External ref out of range" or the "503, Frequency Reference unlocked" error is asserted. Note that this will only take place if the **Freq Ref In** selection is **External**.

With the acquisition stopped, the data display will stop updating (even if this occurs in the middle of a sweep or measurement) and no data will be returned to a READ? or MEASure? query; that is to say, these queries will not complete because the analyzer will not respond to them. Furthermore, no response will be generated to a *WAI? or *OPC? query.

Proper SCPI sequences are shown below, which will always fail to return if the acquisition stops during the requested sweep or measurement. Note that, for predictable operation of this function, it is best to operate the analyzer in single measurement mode (INIT:CONT OFF), because if operating in continuous mode, the analyzer may respond to the above queries even after the acquisition stops, with data left over from the previous acquisition.

```
:INIT:CONT OFF
```

```
:INIT:IMM;*OPC?
```

```
--
```

```
:INIT:CONT OFF
```

```
:INIT:IMM;*WAI?
```

```
--
```

```
:INIT:CONT OFF
```

```
:READ?
```

```
--
```

```
:INIT:CONT OFF
```

```
:MEASure?
```

When the acquisition ceases, in addition to the error condition(s) described above, an error message will be generated informing you that the acquisition has ceased due to an invalid external reference. This message will stay on the screen while the acquisition is suspended.

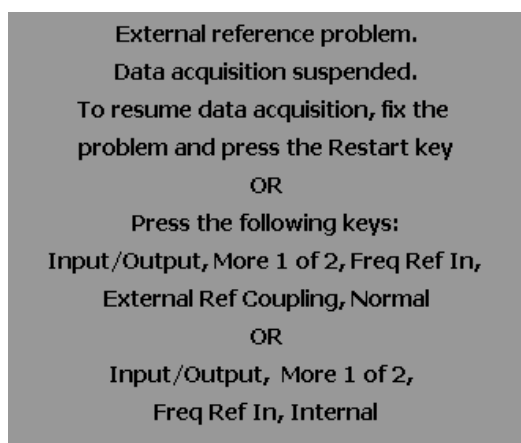

If you press the Restart key this message will be taken off the screen and a new acquisition will be attempted; if the External Reference problem persists the message will go right back up. You can also take the message down by changing back to the **Normal** setting of Sweep/Ext Ref Coupling, or by pressing **Freq Ref In, Internal**, or **Freq Ref In, Sense**, or **Restore Input/Output Defaults**.

The setting of **External Ref Coupling** is persistent across power-cycling and is not reset with **Preset**. It is reset to the default state (**Normal**) when **Restore Input/Output Defaults** is invoked, which will also restart normal data acquisition.

The detection of invalid external reference is under interrupt processing. If the external reference becomes invalid then returns to valid in too short a time, no error condition will be detected or reported and therefore the acquisition will not be stopped.

Remote Command	<code>[:SENSe] :ROSCillator:COUPling NORMal NACquisition</code> <code>[:SENSe] :ROSCillator:COUPling?</code>
Mode	All
Preset	This setting is persistent: it survives power-cycling or Preset and is reset with Restore Input/Output defaults.
State Saved	Not saved in State

Input/Output

Readback	Normal Stop Acq
Key Path:	Input/Output, Freq Ref In
Instrument S/W Revision	A.02.00

Output Config

Accesses keys that configure various output settings, like the frequency reference output, trigger output and analog output.

Key Path	Input/Output
Instrument S/W Revision	Prior to A.02.00

Trig Out (1 and 2)

Select the type of output signal that will be output from the rear panel Trig 1 Out or Trig 2 Out connectors.

Remote Command:	:TRIGger TRIGger1 TRIGger2[:SEquence]:OUTPut HSWP MEASuring MAIN GATE GTRigger OEVEN :TRIGger TRIGger1 TRIGger2[:SEquence]:OUTPut?
------------------------	--

Example: TRIG:OUTP HSWP

Preset: Trigger 1: Sweeping (HSWP)
Trigger 2: Gate

This is unaffected by Preset but is preset to the above values on a "Restore Input/Output Defaults" or "Restore System Defaults->All"

State Saved: Saved in instrument state

Key Path: **Input/Output, Output Config**

Instrument S/W Revision: Prior to A.02.00

Polarity

Sets the output to the Trig 1 Out connector to trigger on either the positive or negative polarity.

Remote Command:	:TRIGger TRIGger1 TRIGger2[:SEquence]:OUTPut:POLarity POSitive NEGative :TRIGger TRIGger1 TRIGger2[:SEquence]:OUTPut:POLarity?
------------------------	--

Example: TRIG1:OUTP:POL POS

Preset: This is unaffected by Preset but is set to POSitive on a "Restore Input/Output Defaults" or "Restore System Defaults->All"

State Saved: Saved in state

Key Path: **Input/Output, Output Config, Trig 1 Output**
 Instrument S/W Revision: Prior to A.02.00

Sweeping (HSWP)

Selects the Sweeping trigger signal to be output to the Trig 1 Out connector. This signal has historically been known as "HSWP" but care should be taken to understand that in this analyzer, its function does not exactly match other products behavior.

Example: TRIG1:OUTP HSWP
 Key Path: **Input/Output, Output Config, Trig 1 Output**
 Readback: Sweeping
 Instrument S/W Revision: Prior to A.02.00

Measuring

Selects the Measuring trigger signal to be output to the Trig 1 Out connector. This signal is true while the Measuring status bit is true.

Example: TRIG1:OUTP MEAS
 Key Path: **Input/Output, Output Config, Trig 1 Output**
 Readback: Measuring
 Instrument S/W Revision: Prior to A.02.00

Main Trigger

Selects the current instrument trigger signal to be output to the Trig 1 Out connector.

Example: TRIG1:OUTP MAIN
 Key Path: **Input/Output, Output Config, Trig 1 Output**
 Readback: Main Trigger
 Instrument S/W Revision: Prior to A.02.00

Gate Trigger

Selects the gate trigger signal to be output to the Trig 1 Out connector. This is the source of the gate timing, not the actual gate signal.

Example: TRIG1:OUTP GTR
 Key Path: **Input/Output, Output Config, Trig 1 Output**
 Readback: Gate Trigger
 Instrument S/W Revision: Prior to A.02.00

Input/Output

Gate

Selects the gate signal to be output to the Trig 1 Out connector. The gate signal has been delayed and its length determined by delay and length settings. When the polarity is positive, a high on the Trig 1 Out represents the time the gate is configured to pass the signal.

Example:	TRIG1:OUTP GATE
Key Path:	Input/Output, Output Config, Trig 1 Output
Readback:	Gate
Instrument S/W Revision:	Prior to A.02.00

Odd/Even Trace Point

Selects either the odd or even trace points as the signal to be output to the Trig 1 Out connector when performing swept spectrum analysis. When the polarity is positive, this output goes high during the time the analyzer is sweeping past the first point (Point 0) and every other following trace point. The opposite is true if the polarity is negative.

Example:	TRIG1:OUTP OEV
Key Path:	Input/Output, Output Config, Trig 1 Output
Readback:	Odd/Even
Instrument S/W Revision:	Prior to A.02.00

Off

Selects no signal to be output to the Trig 1 Out connector.

Example:	TRIG1:OUTP OFF
Key Path:	Input/Output, Output Config, Trig 1 Output
Readback:	Off
Instrument S/W Revision:	Prior to A.02.00

Digital Bus

Opens a menu that allows you to select options for configuring the digital bus output(s) of the analyzer.

Key Path	Input/Output, Output Config
Instrument S/W Revision	Prior to A.02.00

Bus Out

The Digital Bus is a connector located on the rear panel of the instrument. It is a unidirectional link of real time raw ADC data at a 90 MHz rate. No corrections are applied. The ADC is sampling a 22.5 MHz IF. When Bus Out is on, all acquisitions are streamed to the output port including acquisitions for

internal purposes such as Alignment; internal processing and routing of acquisitions continues as usual and is unaffected by the state of Bus Out. This port is intended for use with the Agilent N5105 and N5106 products only. It is not available for general purpose use.

Remote Command	:OUTPut:DBUS [1] [:STATe] ON OFF 1 0 :OUTPut:DBUS [1] [:STATe] ?
Example	OUTP:DBUS ON
Key Path	Input/Output, Output Config, Digital Bus
Scope	Mode Global
Preset	This is unaffected by Preset but is set to Off on a "Restore Input/Output Defaults" or "Restore System Defaults -> All"
State Saved	Saved in instrument state.
Instrument S/W Revision	Prior to A.02.00

I/Q Cal Out

The Baseband I/Q "Cal Out" port can be turned on with either a 1 kHz or a 250 kHz square wave. This can be turned on independent of the input selection. A Preset will reset this to Off.

Remote Command	:OUTPut:IQ:OUTPut IQ1 IQ250 OFF :OUTPut:IQ:OUTPut?
Dependencies/Couplings	An I/Q Cable Calibration or an I/Q Probe Calibration will change the state of the Cal Out port as needed by the calibration routine. When the calibration is finished the I/Q Cal Out is restored to the pre-calibration state.
Example	OUTP:IQ:OUTP IQ1
Key Path	Input/Output, Output Config
Preset	Off
State Saved	Saved in instrument state.
Range	1 kHz Square Wave 250 kHz Square Wave Off
Readback Text	1 kHz 250 kHz Off
Instrument S/W Revision	Prior to A.02.00

1 kHz Square Wave

Turn on the 1 kHz square wave signal at the Cal Out port. This choice is only available with option BBA.

Key Path	Input/Output, Output Config, I/Q Cal Out
Readback	I/Q 1kHz
Instrument S/W Revision	Prior to A.02.00

Input/Output

250 kHz Square Wave

Turn on the 250 kHz square wave signal at the Cal Out port. This choice is only available with option BBA.

Key Path	Input/Output, Output Config, I/Q Cal Out
Readback	I/Q 250kHz
Instrument S/W Revision	Prior to A.02.00

Off

Turn off the signal at the Cal Out port. This choice is only available with option BBA.

Key Path	Input/Output, Output Config, I/Q Cal Out
Readback	Off
Instrument S/W Revision	Prior to A.02.00

I/Q Guided Calibration

Calibrating the Baseband I/Q ports requires several steps and manual connections. The Guided Calibration will interactively step a user through the required steps, displaying diagrams to help with the connections. The steps will vary depending on the setup.

In the Guided Calibration windows, the date and time of the last calibration are displayed. If any of the items listed are displayed in yellow, this indicates that the calibration for that item is inconsistent with the latest calibration, and you should complete the entire calibration process before you exit the calibration.

I/Q Isolation Calibration

The I/Q Isolation Calibration must be run before calibrating any port with either the I/Q Cable Calibration or I/Q Probe Calibration. This calibration is performed with nothing connected to any of the front panel I/Q ports. This is the first step in both the I/Q Cable Calibration and the I/Q Probe Calibration.

Next

Perform the I/Q Isolation calibration.

Remote Command	<code>:CALibration:IQ:ISOLation</code>
Restriction and Notes	All front panel I/Q ports must not be connected to anything.
Remote Command Notes	All cables and probes should be disconnected from the I/Q ports before issuing the SCPI command.
Example	CAL:IQ:ISOL
Key Path	Input/Output, I/Q, I/Q Cable Calibration

State Saved	No.
Instrument S/W Revision	Prior to A.02.00

Exit

Exit the calibration procedure. All ports calibrated before pressing Exit will use the newly acquired calibration data.

Restriction and Notes	Using the Exit button will not restore the calibration data to the state prior to entering the guided calibration. Once a port is calibrated the data is stored immediately and the only way to change it is to redo the calibration step. When the calibration may be left in an inconsistent state, a confirmation dialog will be displayed (see “Exit Confirmation” on page 528).
Key Path	Input/Output, I/Q, I/Q Cable Calibration
Instrument S/W Revision	Prior to A.02.00

I/Q Isolation Calibration Time (Remote Only)

Return the last date and time that the I/Q Isolation Calibration was performed. This is a remote query command only.

Remote Command:	:CALibration:IQ:ISOLation:TIME?
Example:	:CAL:IQ:ISOL:TIME?
Restriction and Notes:	This returns 6 integer values: year, month, day, hour, minute, second. When no calibration has been performed, all values will be 0.
Instrument S/W Revision:	A.02.00

I/Q Cable Calibration

The I/Q cable calibration creates correction data for each of the front panel I/Q ports. This calibration data is used whenever no probe specific calibration data is available. It is important that all ports are calibrated using the same short BNC cable so that the data is comparable from port to port.

The guided calibration (front panel only) will show connection diagrams and guide you through the isolation calibration and calibrating each port. The calibration data for each port is stored separately, so as soon as a port is calibrated that data is saved and will be used. If a user presses "Exit" to exit the calibration process, the data for the ports already completed will still be used. It is recommended that a calibration be completed once started, or if exited, that it be properly done before the next use of the I/Q ports. The "Next" button will perform the calibration for the current port and then proceed to the next step in the calibration procedure. The "Back" button will return to the prior port in the procedure. Both keys and dialog buttons are supplied for ease of use. The dialog buttons are for mouse use and the keys for front panel use.

The calibration can also be done via SCPI, but no connection diagrams will be shown. You will have to make the correct connections before issuing each port calibration command. Again, it is recommended that all ports be calibrated at the same time.

Input/Output

The instrument state remains as it was prior to entering the calibration procedure except while a port is actually being calibrated. Once a port is calibrated it returns to the prior state. A port calibration is in process only from the time the "Next" button is pressed until the next screen is shown. For SCPI, this corresponds to the time from issuing the CAL:IQ:FLAT:I|IB|Q|QB command until the operation is complete.

For example, if the prior instrument state is Cal Out = Off, Input = I+jQ, and Differential = Off, then up until the time the "Next" button is pressed the I Input and Q Input LEDs are on and the Cal Out, I-bar Input and Q-bar Input LEDs are off. Once the "Next" button is pressed for the I port calibration, only the Cal Out and I Input LEDs will be on and the others will be off. When the screen progresses to the next step ("Next" button again enabled), the prior state is restored and only the I Input and Q Input LEDs are on (Cal Out is off again).

The last calibration date and time for each port will be displayed. Any calibrations that are more than a day older than the most recent calibration will be displayed with the color amber.

Key Path	Input/Output, I/Q, I/Q
Instrument S/W Revision	Prior to A.02.00

I Port

The I port calibration is performed with the front panel's I port connected via a short BNC cable to the Cal Out port. The guided calibration will show a diagram of the required connections.

Back

Return to the prior step in the calibration procedure.

Key Path	Input/Output, I/Q, Q Setup, Q Probe, Calibrate
Instrument S/W Revision	Prior to A.02.00

Next

Perform the I port calibration.

Remote Command	<code>:CALibration:IQ:FLATness:I</code>
Restriction and Notes	The recommended procedure is to use the same BNC cable to calibrate all I/Q ports. All I/Q ports should be calibrated sequentially during the procedure. The calibration data is saved as soon as the port is calibrated and will survive power cycles. It is not reset by any preset or restore data commands.
Remote Command Notes	The I port must be connected to the Cal Out port before issuing the SCPI command.
Example	CAL:IQ:FLAT:I
Key Path	Input/Output, I/Q, I/Q Cable Calibration
State Saved	No.
Instrument S/W Revision	Prior to A.02.00

Exit

Exit the calibration procedure. All ports calibrated before pressing Exit will use the newly acquired calibration data.

Restriction and Notes	Using the Exit button will not restore the calibration data to the state prior to entering the guided calibration. Once a port is calibrated the data is stored immediately and the only way to change it is to redo the calibration step. When the calibration may be left in an inconsistent state, a confirmation dialog will be displayed (see “Exit Confirmation” on page 528).
Key Path	Input/Output, I/Q, I/Q Cable Calibration
Instrument S/W Revision	Prior to A.02.00

I-bar Port

The I-bar port calibration is performed with the front panel's I-bar port connected via a short BNC cable to the Cal Out port. The guided calibration will show a diagram of the required connections.

Back

Return to the prior step in the calibration procedure.

Restriction and Notes	Using the Back button will not restore the calibration data to a prior state. Once a port is calibrated the data is stored immediately and the only way to change it is to redo the calibration step. The Back button allows you to go back to a prior step to redo that calibration step.
Key Path	Input/Output, I/Q, I/Q Cable Calibration
Instrument S/W Revision	Prior to A.02.00

Next

Perform the I-bar port calibration.

Remote Command	<code>:CALibration:IQ:FLATness:IBAR</code>
Restriction and Notes	The recommended procedure is to use the same BNC cable to calibrate all I/Q ports. All I/Q ports should be calibrated sequentially during the procedure. The calibration data is saved as soon as the port is calibrated and will survive power cycles. It is not reset by any preset or restore data commands.
Remote Command Notes	The I-bar port must be connected to the Cal Out port before issuing the SCPI command.
Example	<code>CAL:IQ:FLAT:IBAR</code>
Key Path	Input/Output, I/Q, I/Q Cable Calibration
State Saved	No
Instrument S/W Revision	Prior to A.02.00

Input/Output

Exit

Exit the calibration procedure. All ports calibrated before pressing Exit will use the newly acquired calibration data.

Restriction and Notes Using the Exit button will not restore the calibration data to the state prior to entering the guided calibration. Once a port is calibrated the data is stored immediately and the only way to change it is to redo the calibration step.

When the calibration may be left in an inconsistent state, a confirmation dialog will be displayed (see [“Exit Confirmation” on page 528](#)).

Key Path **Input/Output, I/Q, I/Q Cable Calibration**

Instrument S/W Revision Prior to A.02.00

Q Port

The Q port calibration is performed with the front panel's Q port connected via a short BNC cable to the Cal Out port. The guided calibration will show a diagram of the required connections.

Back

Return to the prior step in the calibration procedure.

Restriction and Notes Using the Back button will not restore the calibration data to a prior state. Once a port is calibrated the data is stored immediately and the only way to change it is to redo the calibration step. The Back button allows you to go back to a prior step to redo that calibration step.

Key Path **Input/Output, I/Q, I/Q Cable Calibration**

Instrument S/W Revision Prior to A.02.00

Next

Perform the Q port calibration.

Remote Command :CALibration:IQ:FLATness:Q

Restriction and Notes The recommended procedure is to use the same BNC cable to calibrate all I/Q ports. All I/Q ports should be calibrated sequentially during the procedure. The calibration data is saved as soon as the port is calibrated and will survive power cycles. It is not reset by any preset or restore data commands.

Remote Command Notes The Q port must be connected to the Cal Out port before issuing the SCPI command.

Example CAL:IQ:FLAT:Q

Key Path **Input/Output, I/Q, I/Q Cable Calibration**

State Saved No

Instrument S/W Revision Prior to A.02.00

Exit

Exit the calibration procedure. All ports calibrated before pressing Exit will use the newly acquired calibration data.

Restriction and Notes	Using the Exit button will not restore the calibration data to the state prior to entering the guided calibration. Once a port is calibrated the data is stored immediately and the only way to change it is to redo the calibration step. When the calibration may be left in an inconsistent state, a confirmation dialog will be displayed (see “Exit Confirmation” on page 528).
Key Path	Input/Output, I/Q, I/Q Cable Calibration
Instrument S/W Revision	Prior to A.02.00

Q-bar Port

The Q-bar port calibration is performed with the front panel's Q-bar port connected via a short BNC cable to the Cal Out port. The guided calibration will show a diagram of the required connections.

Back

Return to the prior step in the calibration procedure.

Restriction and Notes	Using the Back button will not restore the calibration data to a prior state. Once a port is calibrated the data is stored immediately and the only way to change it is to redo the calibration step. The Back button allows you to go back to a prior step to redo that calibration step.
Key Path	Input/Output, I/Q, I/Q Cable Calibration
Instrument S/W Revision	Prior to A.02.00

Next

Perform the Q-bar port calibration.

Remote Command	<code>:CALibration:IQ:FLATness:QBAR</code>
Restriction and Notes	The recommended procedure is to use the same BNC cable to calibrate all I/Q ports. All I/Q ports should be calibrated sequentially during the procedure. The calibration data is saved as soon as the port is calibrated and will survive power cycles. It is not reset by any preset or restore data commands.
Remote Command Notes	The Q-bar port must be connected to the Cal Out port before issuing the SCPI command.
Example	<code>CAL:IQ:FLAT:QBAR</code>
Key Path	Input/Output, I/Q, I/Q Cable Calibration
State Saved	No
Instrument S/W Revision	Prior to A.02.00

Input/Output

Exit

Exit the calibration procedure. All ports calibrated before pressing Exit will use the newly acquired calibration data.

Restriction and Notes Using the Exit button will not restore the calibration data to the state prior to entering the guided calibration. Once a port is calibrated the data is stored immediately and the only way to change it is to redo the calibration step.

When the calibration may be left in an inconsistent state, a confirmation dialog will be displayed (see [“Exit Confirmation” on page 528](#)).

Key Path **Input/Output, I/Q, I/Q Cable Calibration**

Instrument S/W Revision Prior to A.02.00

I/Q Cable Calibration Time (Remote Command Only)

Return the last date and time that the I/Q Cable Calibration was performed for a specific port. This is a remote query command only.

Remote Command: :CALibration:IQ:FLATness:I|IBAR|Q|QBAR:TIME?

Example: :CAL:IQ:FLAT:I:TIME?

Restriction and Notes: This returns 6 integer values: year, month, day, hour, minute, second. When no calibration has been performed, all values will be 0.

Instrument S/W Revision: A.02.00

I/Q Probe Calibration

The I/Q probe calibration creates correction data for one of the front panel I/Q channels. When the probe has EEPROM identification, the data is unique to that specific probe. When the probe does not have EEPROM identification, the data will be used for all probes of the same type. The data is also unique to the channel, so calibration data for the I channel will not be used for the Q channel and vice versa.

The guided calibration (front panel only) will show connection diagrams and guide you through the I/Q Isolation Calibration and through calibrating each port. The calibration data for each port is stored separately, so as soon as a port is calibrated that data is saved and will be used. If a user presses "Exit" to exit the calibration process, the data for the port already completed will still be used. It is recommended that a calibration be completed once started, or if exited, that it be properly done before the next use of the probe. The "Next" button will perform the calibration for the current port and then proceed to the next step in the calibration procedure. The "Back" button will return to the prior port in the procedure. Both keys and dialog buttons are supplied for ease of use. The dialog buttons are for mouse use and the keys for front panel use.

The calibration can also be done via SCPI, but no connection diagrams will be shown. You will have to make the correct connections before issuing each port calibration command. Again, it is recommended that all ports be calibrated at the same time.

For Active probes or when Differential is Off, only the main port is calibrated, otherwise both the main and complementary ports are calibrated.

The instrument state remains as it was prior to entering the calibration procedure except while a port is actually being calibrated. Once a port is calibrated it returns to the prior state. A port calibration is in process only from the time the "Next" button is pressed until the next screen is shown. For SCPI, this corresponds to the time from issuing the CAL:IQ:PROB:I|IB|Q|QB command until the operation is complete.

For example, if the prior instrument state is Cal Out = Off, Input = I+jQ, and Differential = Off, then up until the time the "Next" button is pressed the I Input and Q Input LEDs are on and the Cal Out, I-bar Input and Q-bar Input LEDs are off. Once the "Next" button is pressed for the I port calibration, only the Cal Out and I Input LEDs will be on and the others will be off. When the screen progresses to the next step ("Next" button again enabled), the prior state is restored and only the I Input and Q Input LEDs are on (Cal Out is off again).

The last calibration date and time for each relevant port will be displayed. For passive probes with Differential On, any calibration that is more than a day older than the most recent calibration will be displayed with the color amber.

I Port

The I port calibration is performed with the probe body attached to the front panel's I port and the probe tip connected via an adapter to the Cal Out port. The guided calibration will show a diagram of the required connections.

Show Adapter

Show a connection diagram and instructions for the probe and adapter. See ["Show Adapter Screen" on page 528](#).

Restriction and Notes	Either a passive or an active probe adapter diagram will be shown, depending on the type of probe attached.
Key Path	Input/Output, I/Q, I Setup, I Probe, Calibrate
Instrument S/W Revision	Prior to A.02.00

Back

Return to the prior step in the calibration procedure.

Key Path	Input/Output, I/Q, Q Setup, Q Probe, Calibrate
Instrument S/W Revision	Prior to A.02.00

Next

Perform the I port calibration.

Remote Command	:CALibration:IQ:PROBe:I
Remote Command Notes	The I port must be connected to the Cal Out port before issuing the SCPI command. The calibration data is saved as soon as the port is calibrated and will survive power cycles. It is not reset by any preset or restore data commands.
Example	CAL:IQ:PROB:I

Input/Output

Key Path	Input/Output, I/Q, I Setup, I Probe, Calibrate
State Saved	No
Instrument S/W Revision	Prior to A.02.00

Exit

Exit the calibration procedure. All ports calibrated before pressing Exit will use the newly acquired calibration data.

Restriction and Notes	Using the Exit button will not restore the calibration data to the state prior to entering the guided calibration. Once a port is calibrated the data is stored immediately and the only way to change it is to redo the calibration step.
-----------------------	--

When the calibration may be left in an inconsistent state, a confirmation dialog will be displayed (see [“Exit Confirmation” on page 528](#)).

Key Path	Input/Output, I/Q, I Setup, I Probe, Calibrate
Instrument S/W Revision	Prior to A.02.00

I-bar Port

The I-bar port calibration is performed with the probe body attached to the front panel's I-bar port and the probe tip connected via an adapter to the Cal Out port. The I-bar probe calibration is only available for passive probes with Differential On. The guided calibration will show a diagram of the required connections.

Show Adapter

Show a connection diagram and instructions for the probe and adapter. See [“Show Adapter Screen” on page 528](#).

Restriction and Notes	Either a passive or an active probe adapter diagram will be shown, depending on the type of probe attached.
-----------------------	---

Key Path	Input/Output, I/Q, I Setup, I Probe, Calibrate
Instrument S/W Revision	Prior to A.02.00

Back

Return to the prior step in the calibration procedure.

Restriction and Notes	Using the Back button will not restore the calibration data to a prior state. Once a port is calibrated the data is stored immediately and the only way to change it is to redo the calibration step. The Back button allows you to go back to a prior step to redo that calibration step.
-----------------------	--

Key Path	Input/Output, I/Q, I Setup, I Probe, Calibrate
Instrument S/W Revision	Prior to A.02.00

Next

Perform the I-bar port calibration.

Remote Command	:CALibration:IQ:PROBe:IBar
Remote Command Notes	The I-bar port must be connected to the Cal Out port before issuing the SCPI command. The calibration data is saved as soon as the port is calibrated and will survive power cycles. It is not reset by any preset or restore data commands.
Example	CAL:IQ:PROB:IB
Key Path	Input/Output, I/Q, I Setup, I Probe, Calibrate
State Saved	No
Instrument S/W Revision	Prior to A.02.00

Exit

Exit the calibration procedure. All ports calibrated before pressing Exit will use the newly acquired calibration data.

Restriction and Notes	Using the Exit button will not restore the calibration data to the state prior to entering the guided calibration. Once a port is calibrated the data is stored immediately and the only way to change it is to redo the calibration step. When the calibration may be left in an inconsistent state, a confirmation dialog will be displayed (see “Exit Confirmation” on page 528).
Key Path	Input/Output, I/Q, I Setup, I Probe, Calibrate
Instrument S/W Revision	Prior to A.02.00

Q Port

The Q port calibration is performed with the probe body attached to the front panel's Q port and the probe tip connected via an adapter to the Cal Out port. The guided calibration will show a diagram of the required connections.

Show Adapter

Show a connection diagram and instructions for the probe and adapter. See [“Show Adapter Screen” on page 528](#).

Restriction and Notes	Either a passive or an active probe adapter diagram will be shown, depending on the type of probe attached.
Key Path	Input/Output, I/Q, Q Setup, Q Probe, Calibrate
Instrument S/W Revision	Prior to A.02.00

Input/Output

Back

Return to the prior step in the calibration procedure.

Key Path	Input/Output, I/Q, Q Setup, Q Probe, Calibrate
Instrument S/W Revision	Prior to A.02.00

Next

Perform the Q port calibration.

Remote Command	:CALibration:IQ:PROBe:Q
Remote Command Notes	The Q port must be connected to the Cal Out port before issuing the SCPI command. The calibration data is saved as soon as the port is calibrated and will survive power cycles. It is not reset by any preset or restore data commands.
Example	CAL:IQ:PROB:Q
Key Path	Input/Output, I/Q, Q Setup, Q Probe, Calibrate
State Saved	No
Instrument S/W Revision	Prior to A.02.00

Exit

Exit the calibration procedure. All ports calibrated before pressing Exit will use the newly acquired calibration data.

Restriction and Notes	Using the Exit button will not restore the calibration data to the state prior to entering the guided calibration. Once a port is calibrated the data is stored immediately and the only way to change it is to redo the calibration step. When the calibration may be left in an inconsistent state, a confirmation dialog will be displayed (see “Exit Confirmation” on page 528).
Key Path	Input/Output, I/Q, Q Setup, Q Probe, Calibrate
Instrument S/W Revision	Prior to A.02.00

Q-bar Port

The Q-bar port calibration is performed with the probe body attached to the front panel's Q-bar port and the probe tip connected via an adapter to the Cal Out port. The Q-bar probe calibration is only available for passive probes with Differential On. The guided calibration will show a diagram of the required connections.

Show Adapter

Show a connection diagram and instructions for the probe and adapter. See [“Show Adapter Screen” on page 528](#).

Restriction and Notes	Either a passive or an active probe adapter diagram will be shown, depending on the type of probe attached.
Key Path	Input/Output, I/Q, Q Setup, Q Probe, Calibrate
Instrument S/W Revision	Prior to A.02.00

Back

Return to the prior step in the calibration procedure.

Restriction and Notes	Using the Back button will not restore the calibration data to a prior state. Once a port is calibrated the data is stored immediately and the only way to change it is to redo the calibration step. The Back button allows you to go back to a prior step to redo that calibration step.
Key Path	Input/Output, I/Q, Q Setup, Q Probe, Calibrate
Instrument S/W Revision	Prior to A.02.00

Next

Perform the Q-bar port calibration.

Remote Command	<code>:CALibration:IQ:PROBe:QBar</code>
Remote Command Notes	The Q-bar port must be connected to the Cal Out port before issuing the SCPI command. The calibration data is saved as soon as the port is calibrated and will survive power cycles. It is not reset by any preset or restore data commands.
Example	<code>CAL:IQ:PROB:QB</code>
Key Path	Input/Output, I/Q, Q Setup, Q Probe, Calibrate
State Saved	No
Instrument S/W Revision	Prior to A.02.00

Exit

Exit the calibration procedure. All ports calibrated before pressing Exit will use the newly acquired calibration data.

Restriction and Notes	Using the Exit button will not restore the calibration data to the state prior to entering the guided calibration. Once a port is calibrated the data is stored immediately and the only way to change it is to redo the calibration step. When the calibration may be left in an inconsistent state, a confirmation dialog will be displayed (see “Exit Confirmation” on page 528).
-----------------------	--

Input/Output

Key Path **Input/Output, I/Q, Q Setup, Q Probe, Calibrate**

Instrument S/W Revision Prior to A.02.00

Show Adapter Screen

When one of the Probe Calibration Show Adapter buttons is pressed, a diagram of the probe with its adapter will be shown. Depending on the type of probe attached, either the Passive Probe Adapter or the Active Probe Adapter diagram will be shown.

I/Q Probe Calibration Time (Remote Command Only)

Return the last date and time that the I/Q Probe Calibration was performed for a specific port. This is a remote query command only.

Remote Command: :CALibration:IQ:PROBE:I|IBAR|Q|QBAR:TIME?

Example: :CAL:IQ:PROB:I:TIME?

Restriction and Notes: This returns 6 integer values: year, month, day, hour, minute, second. When no calibration has been performed, all values will be 0. The value is specific to both the port and probe, so the value will change as probes are connected or disconnected.

Instrument S/W Revision: A.02.00

Exit Confirmation

When Exit is pressed during one of the calibration routines, the calibration may be in an inconsistent state with some of the ports having newly measured calibration data and others with old data. If this is the case, a dialog box will appear to confirm that you really want to exit. A "Yes" answer will exit the calibration procedure, leaving potentially inconsistent calibration data in place. A "No" answer will return to the calibration procedure.

Marker

Some Marker operation is common across multiple Modes and Measurements. These common features are described in this section. See the Measurement description for information on features that are unique.

The Marker key accesses the Marker menu. A marker can be placed on a trace to allow the value of the trace at the marker point to be determined precisely. The functions in this menu include a 1-of-N selection of the control mode Normal, Delta, Fixed, or Off for the selected marker. If the selected marker is Off, pressing Marker sets it to Normal and places it at the center of the screen on the trace determined by the Marker Trace rules.

Markers may also be used in pairs to read the difference (or delta) between two data points. They can be used in Marker Functions to do advanced data processing, or to specify operating points in functions like Signal Track and N dB Points.

Key Path	Front-panel key
Instrument S/W Revision	Prior to A.02.00

Marker

Marker Function

Some Marker Functions are common across multiple Modes and Measurements. These common features are described in this section. See the Measurement description for information on features that are unique.

The Marker Function key opens up a menu of keys that allow you to control the Marker Functions of the instrument. Marker Functions perform post-processing operations on marker data. Band Functions are Marker Functions that allow you to define a band of frequencies around the marker. The band defines the region of data used for the numerical calculations. These marker functions also allow you to perform mathematical calculations on trace and marker data and report the results of these calculations in place of the normal marker result.

Unlike regular markers, marker function markers are not placed directly on the trace. They are placed at a location which is relative to the result of the function calculation.

Key Path	Front-panel key
Instrument S/W Revision	Prior to A.02.00

Marker Function

Marker To

Some Marker To operation is common across multiple Modes and Measurements. These common features are described in this section. See the Measurement description for information on features that are unique.

Key Path	Front-panel key
Instrument S/W Revision	Prior to A.02.00

Marker To

Meas

The information in this section is common to all measurements. For key and remote command information on each measurement, refer to the section which describes the measurement of interest.

Measurements available under the Meas key are specific to the current Mode.

When viewing Help for measurements, note the following:

NOTE Operation for some keys differs between measurements. The information displayed in Help pertains to the current measurement. To see how a key operates in a different measurement, exit Help (press the Cancel Esc key), select the measurement, then reenter Help (press the Help key) and press that key.

Key Path	Front-panel key
Instrument S/W Revision	Prior to A.02.00

Remote Measurement Functions

This section contains the following topics:

[“Measurement Group of Commands” on page 536](#)

[“Current Measurement Query \(Remote Command Only\)” on page 539](#)

[“Limit Test Current Results \(Remote Command Only\)” on page 539](#)

[“Data Query \(Remote Command Only\)” on page 539](#)

[“Calculate/Compress Trace Data Query \(Remote Command Only\)” on page 539](#)

[“Calculate Peaks of Trace Data \(Remote Command Only\)” on page 544](#)

[“Format Data: Numeric Data \(Remote Command Only\)” on page 546](#)

[“Format Data: Byte Order \(Remote Command Only\)” on page 547](#)

Instrument S/W Revision	Prior to A.02.00
-------------------------	------------------

Measurement Group of Commands

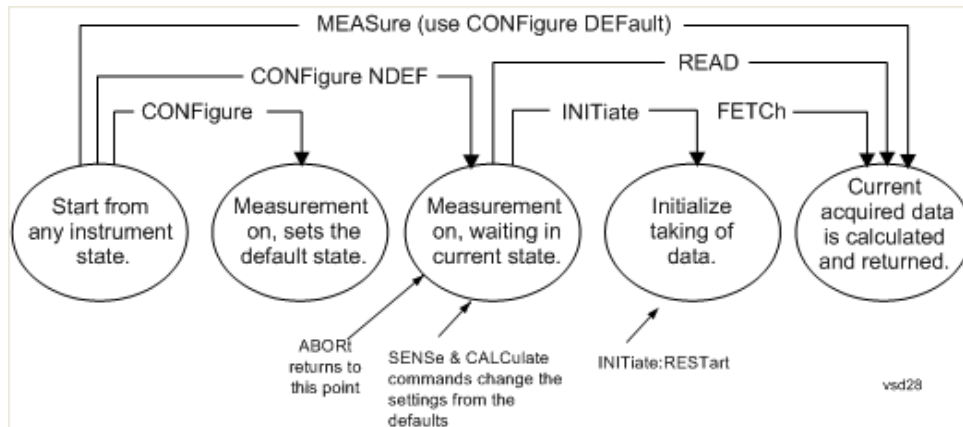

Measure Commands:

:MEASure:<measurement>[n]?

This is a fast single-command way to make a measurement using the factory default instrument settings. These are the settings and units that conform to the Mode Setup settings (e.g. radio standard) that you have currently selected.

- Stops the current measurement (if any) and sets up the instrument for the specified measurement using the factory defaults
- Initiates the data acquisition for the measurement
- Blocks other SCPI communication, waiting until the measurement is complete before returning results.
- If the function does averaging, it is turned on and the number of averages is set to 10.
- After the data is valid it returns the scalar results, or the trace data, for the specified measurement. The type of data returned may be defined by an [n] value that is sent with the command.

The scalar measurement results will be returned if the optional [n] value is not included, or is set to 1. If the [n] value is set to a value other than 1, the selected trace data results will be returned. See each command for details of what types of scalar results or trace data results are available.

ASCII is the default format for the data output. (Older versions of Spectrum Analysis and Phase Noise mode measurements only use ASCII.) The binary data formats should be used for handling large blocks of data since they are smaller and faster than the ASCII format. Refer to the FORMat:DATA command for more information.

If you need to change some of the measurement parameters from the factory default settings you can set up the measurement with the CONFigure command. Use the commands in the SENSe:<measurement> and CALCulate:<measurement> subsystems to change the settings. Then you can use the READ? command to initiate the measurement and query the results.

If you need to repeatedly make a given measurement with settings other than the factory defaults, you can use the commands in the SENSe:<measurement> and CALCulate:<measurement> subsystems to set up the measurement. Then use the READ? command to initiate the measurement and query results.

Measurement settings persist if you initiate a different measurement and then return to a previous one. Use READ:<measurement>? if you want to use those persistent settings. If you want to go back to the default settings, use MEASure:<measurement>?.

Configure Commands:**:CONFigure:<measurement>**

This command stops the current measurement (if any) and sets up the instrument for the specified measurement using the factory default instrument settings. It does not initiate the taking of measurement data unless INIT:CONTinuous is ON. If you change any measurement settings after using the CONFigure command, the READ command can be used to initiate a measurement without changing the settings back to their defaults.

In the Swept SA measurement in Spectrum Analyzer mode the CONFigure command also turns the averaging function on and sets the number of averages to 10 for all measurements.

:CONFigure:NDEFault<measurement> stops the current measurement and changes to the specified measurement. It does not change the settings to the defaults. It does not initiate the taking of measurement data unless INIT:CONTinuous is ON.

The **CONFigure?** query returns the current measurement name.

The **CONFigure:CATalog?** query returns a quoted string of all measurement names in the current mode. For example, "SAN, CHP, OBW, ACP, PST, TXP, SPUR, SEM, LIST".

Fetch Commands:

:FETCh:<measurement>[n]?

This command puts selected data from the most recent measurement into the output buffer. Use FETCh if you have already made a good measurement and you want to return several types of data (different [n] values, for example, both scalars and trace data) from a single measurement. FETCh saves you the time of re-making the measurement. You can only FETCh results from the measurement that is currently active, it will not change to a different measurement. An error is reported if a measurement other than the current one, is specified.

If you need to get new measurement data, use the READ command, which is equivalent to an INITiate followed by a FETCh.

The scalar measurement results will be returned if the optional [n] value is not included, or is set to 1. If the [n] value is set to a value other than 1, the selected trace data results will be returned. See each command for details of what types of scalar results or trace data results are available. The binary data formats should be used for handling large blocks of data since they are smaller and transfer faster than the ASCII format. (FORMat:DATA)

FETCh may be used to return results other than those specified with the original READ or MEASure command that you sent.

INITiate Commands:

:INITiate:<measurement>

This command is not available for measurements in all the instrument modes:

- Initiates a trigger cycle for the specified measurement, but does not output any data. You must then use the FETCh<meas> command to return data. If a measurement other than the current one is specified, the instrument will switch to that measurement and then initiate it.
- For example, suppose you have previously initiated the ACP measurement, but now you are running the channel power measurement. If you send INIT:ACP? it will change from channel power to ACP and will initiate an ACP measurement.
- Does not change any of the measurement settings. For example, if you have previously started the ACP measurement and you send INIT:ACP? it will initiate a new ACP measurement using the same instrument settings as the last time ACP was run.
- If your selected measurement is currently active (in the idle state) it triggers the measurement, assuming the trigger conditions are met. Then it completes one trigger cycle. Depending upon the measurement and the number of averages, there may be multiple data acquisitions, with multiple trigger events, for one full trigger cycle. It also holds off additional commands on GPIB until the acquisition is complete.

READ Commands:

:READ:<measurement>[n]?

- Does not preset the measurement to the factory default settings. For example, if you have previously initiated the ACP measurement and you send READ:ACP? it will initiate a new measurement using the same instrument settings.
- Initiates the measurement and puts valid data into the output buffer. If a measurement other than the current one is specified, the instrument will switch to that measurement before it initiates the measurement and returns results.

For example, suppose you have previously initiated the ACP measurement, but now you are running the channel power measurement. Then you send READ:ACP? It will change from channel power back to ACP and, using the previous ACP settings, will initiate the measurement and return results.

- Blocks other SCPI communication, waiting until the measurement is complete before returning the results

If the optional [n] value is not included, or is set to 1, the scalar measurement results will be returned. If the [n] value is set to a value other than 1, the selected trace data results will be returned. See each command for details of what types of scalar results or trace data results are available. The binary data formats should be used when handling large blocks of data since they are smaller and faster than the ASCII format.

(FORMat:DATA)

Current Measurement Query (Remote Command Only)

This command returns the name of the measurement that is currently running.

Remote Command: :CONFigure?

Example: CONF?

Instrument S/W Revision: Prior to A.02.00

Limit Test Current Results (Remote Command Only)

Queries the status of the current measurement limit testing. It returns a 0 if the measured results pass when compared with the current limits. It returns a 1 if the measured results fail any limit tests.

Remote Command: :CALCulate:CLIMits:FAIL?

Example: CALC:CLIM:FAIL? queries the current measurement to see if it fails the defined limits.

Returns a 0 or 1: 0 it passes, 1 it fails.

Instrument S/W Revision: Prior to A.02.00

Data Query (Remote Command Only)

Returns the designated measurement data for the currently selected measurement and subopcode.

n = any valid subopcode for the current measurement. See the measurement command results table for your current measurement, for information about what data is returned for the subopcodes.

This command uses the data setting specified by the FORMat:BORDER and FORMat:DATA commands and can return real or ASCII data. (See the format command descriptions under Input/Output in the Analyzer Setup section.)

Remote Command: :CALCulate:DATA [n] ?

Notes: The return trace depends on the measurement.

In CALCulate:<meas>:DATA[n], n is any valid subopcode for the current measurement. It returns the same data as the FETCh:<measurement>? query where <measurement> is the current measurement.

Instrument S/W Revision: Prior to A.02.00

Calculate/Compress Trace Data Query (Remote Command Only)

Returns compressed data for the currently selected measurement and sub-opcode [n].

n = any valid sub-opcode for that measurement. See the MEASure:<measurement>? command description of your specific measurement for information on the data that can be returned.

The data is returned in the current Y Axis Unit of the analyzer. The command is used with a sub-opcode <n> (default=1) to specify the trace. With trace queries, it is best if the analyzer is not sweeping during the query. Therefore, it is generally advisable to be in Single Sweep, or Update=Off.

Meas

This command is used to compress or decimate a long trace to extract and return only the desired data. A typical example would be to acquire N frames of GSM data and return the mean power of the first burst in each frame. The command can also be used to identify the best curve fit for the data.

Remote Command: `:CALCulate:DATA<n>:COMPRESS?
BLOCK|CFIT|MAXimum|MINimum|MEAN|DMEan|RMS|RMSCubed|SAMP
le|SDEVIation|PPHase
[,<soffset>[,<length>[,<roffset>[,<rlimit>]]]]`

Remote Command Notes: The command supports 5 parameters. Note that the last 4 (<soffset>,<length>,<roffset>,<rlimit>) are optional. But these optional parameters must be entered in the specified order. For example, if you want to specify <length>, then you must also specify <soffset>. See details below for a definition of each of these parameters.

This command uses the data in the format specified by `FORMAT:DATA`, returning either binary or ASCII data.

Example: To query the mean power of a set of GSM bursts:
Supply a signal that is a set of GSM bursts.
Select the IQ Waveform measurement (in IQ Analyzer Mode).
Set the sweep time to acquire at least one burst.
Set the triggers such that acquisition happens at a known position relative to a burst.
Then query the mean burst levels using, `CALC:DATA2:COMP?
MEAN,24e-6,526e-6` (These parameter values correspond to GSM signals, where 526e-6 is the length of the burst in the slot and you just want 1 burst.)

Instrument S/W Revision: Prior to A.02.00

- **BLOCK** or block data - returns all the data points from the region of the trace data that you specify. For example, it could be used to return the data points of an input signal over several timeslots, excluding the portions of the trace data that you do not want. (This is x,y pairs for trace data and I,Q pairs for complex data.)
- **CFIT** or curve fit - applies curve fitting routines to the data. <soffset> and <length> are required to define the data that you want. <roffset> is an optional parameter for the desired order of the curve equation. The query will return the following values: the x-offset (in seconds) and the curve coefficients ((order + 1) values).

MIN, **MAX**, **MEAN**, **DME**, **RMS**, **RMSC**, **SAMP**, **SDEV** and **PPH** return one data value for each specified region (or <length>) of trace data, for as many regions as possible until you run out of trace data (using <roffset> to specify regions). Or they return the number of regions you specify (using <rlimit>) ignoring any data beyond that.

- **MINimum** - returns the minimum data point (x,y pair) for the specified region(s) of trace data. For I/Q trace data, the minimum magnitude of the I/Q pairs is returned.
- **MAXimum** - returns the maximum data point (x,y pair) for the specified region(s) of trace data. For I/Q trace data, the maximum magnitude of the I/Q pairs is returned.

MEAN - returns a single value that is the arithmetic mean of the data point values (in dB/ dBm) for the specified region(s) of trace data. For I/Q trace data, the mean of the magnitudes of the I/Q pairs is returned. See the following equations.

NOTE If the original trace data is in dB, this function returns the arithmetic mean of those log values, not log of the mean power which is a more useful value. The mean of the log is the better measurement technique when measuring CW signals in the presence of noise. The mean of the power, expressed in dB, is useful in power measurements such as Channel Power. To achieve the mean of the power, use the RMS option.

Equation 1
Mean Value of Data Points for Specified Region(s)

$$\text{MEAN} = \frac{1}{n} \sum_{X_i \in \text{region}(s)} X_i \quad \text{vsd27-1}$$

where X_i is a data point value, and n is the number of data points in the specified region(s).

Equation 2
Mean Value of I/Q Data Pairs for Specified Region(s)

$$\text{MEAN} = \frac{1}{n} \sum_{X_i \in \text{region}(s)} |X_i| \quad \text{vsd27-2}$$

where $|X_i|$ is the magnitude of an I/Q pair, and n is the number of I/Q pairs in the specified region(s).

- DMEan - returns a single value that is the mean power (in dB/ dBm) of the data point values for the specified region(s) of trace data. See the following equation:

Equation 3
DMEan Value of Data Points for Specified Region(s)

$$\text{DME} = 10 \times \log_{10} \left(\frac{1}{n} \sum_{X_i \in \text{region}(s)} \frac{X_i}{10} \right) \quad \text{vsd27-3}$$

- RMS - returns a single value that is the average power on a root-mean-squared voltage scale (arithmetic rms) of the data point values for the specified region(s) of trace data. See the following equation.

For I/Q trace data, the rms of the magnitudes of the I/Q pairs is returned. See the following equation.

NOTE This function is very useful for I/Q trace data. However, if the original trace data is in dB, this function returns the rms of the log values which is not usually needed.

Equation 4
RMS Value of Data Points for Specified Region(s)

$$\text{RMS} = \sqrt{\frac{1}{n} \sum_{X_i \in \text{region}(s)} X_i^2}$$

vsd27-4

where X_i is a data point value, and n is the number of data points in the specified region(s).

Equation 5
RMS Value of I/Q Data Pairs for Specified Region(s)

$$\text{RMS} = \sqrt{\frac{1}{n} \sum_{X_i \in \text{region}(s)} X_i X_i^*}$$

vsd27-5

where X_i is the complex value representation of an I/Q pair, X_i^* its conjugate complex number, and n is the number of I/Q pairs in the specified region(s).

Once you have the rms value for a region of trace data (linear or I/Q), you may want to calculate the mean power. You must convert this rms value (peak volts) to power in dBm:

$$10 \times \log[10 \times (\text{rms value})^2]$$

- **SAMPLE** - returns the first data value (x,y pair) for the specified region(s) of trace data. For I/Q trace data, the first I/Q pair is returned.
- **SDEViation** - returns a single value that is the arithmetic standard deviation for the data point values for the specified region(s) of trace data. See the following equation.

For I/Q trace data, the standard deviation of the magnitudes of the I/Q pairs is returned. See the following equation.

Equation 6
Standard Deviation of Data Point Values for Specified Region(s)

$$\text{SDEV} = \sqrt{\frac{1}{n} \sum_{X_i \in \text{region}(s)} (X_i - \bar{X})^2}$$

vsd27-7

where X_i is a data point value, \bar{X} is the arithmetic mean of the data point values for the specified region(s), and n is the number of data points in the specified region(s).

$$\text{SDEV} = \sqrt{\frac{1}{n} \sum_{X_i \in \text{region}(s)} (|X_i| - \bar{X})^2}$$

vsd27-8

where $|X_i|$ is the magnitude of an I/Q pair, \bar{X} is the mean of the magnitudes for the specified region(s), and n is the number of data points in the specified region(s).

- PPHase - returns the x,y pairs of both rms power (dBm) and arithmetic mean phase (radian) for every specified region and frequency offset (Hz). The number of pairs is defined by the specified number of regions. This parameter can be used for I/Q vector (n=0) in Waveform (time domain) measurement and all parameters are specified by data point in PPHase.

The rms power of the specified region may be expressed as:

$$\text{Power} = 10 \times \log [10 \times (\text{RMS I/Q value})] + 10.$$

The RMS I/Q value (peak volts) is:

$$\sqrt{\frac{1}{n} \sum_{X_i \in \text{region}} X_i X_i^*}$$

vsd27-9

where X_i is the complex value representation of an I/Q pair, X_i^* its conjugate complex number, and n is the number of I/Q pairs in the specified region.

The arithmetic mean phase of the specified region may be expressed as:

$$\frac{1}{n} \sum_{Y_i \in \text{region}} Y_i$$

vsd27-10

where Y_i is the unwrapped phase of I/Q pair with applying frequency correction and n is the number of I/Q pairs in the specified region.

The frequency correction is made by the frequency offset calculated by the arithmetic mean of every specified region's frequency offset. Each frequency offset is calculated by the least square method against the unwrapped phase of I/Q pair.

Sample Trace Data - Constant Envelope

(See below for explanation of variables.)

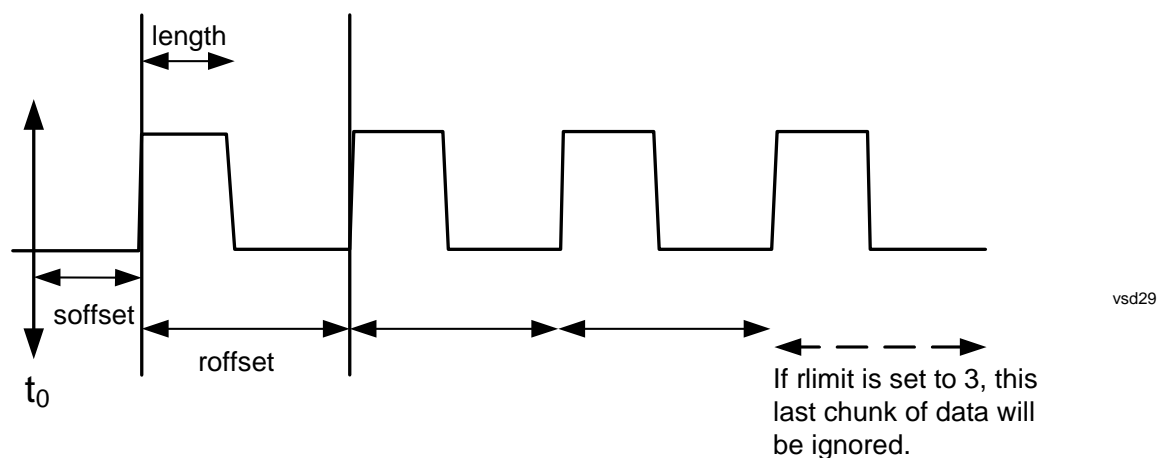

Sample Trace Data - Not Constant Envelope

(See below for explanation of variables.)

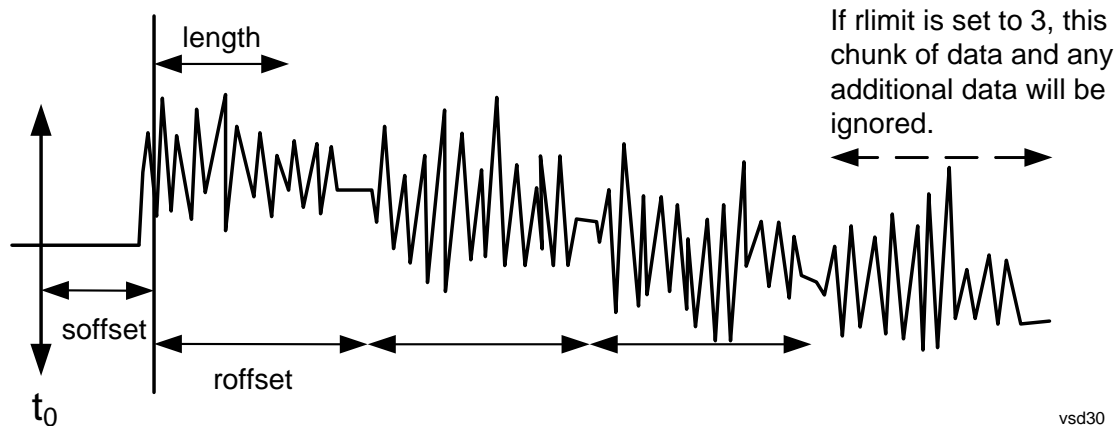

<offset> - start offset is an optional real number. (It is in seconds for time-domain traces, and is a dimensionless index 0 to Npoints – 1, for frequency-domain traces). It specifies the amount of data at the beginning of the trace that will be ignored before the decimation process starts. It is the time or frequency change from the start of the trace to the point where you want to start using the data. The default value is zero.

<length> - is an optional real number. (It is in seconds for time-domain traces, and is a dimensionless index 0 to Npoints – 1, for frequency-domain traces). It defines how much data will be compressed into one value. This parameter has a default value equal to the current trace length.

<roffset> - repeat offset is an optional real number. (It is in seconds for time-domain traces, and is a dimensionless index 0 to Npoints – 1, for frequency-domain traces). It defines the beginning of the next field of trace elements to be compressed. This is relative to the beginning of the previous field. This parameter has a default value equal to the <length> variable. Note that this parameter is used for a completely different purpose when curve fitting (see CFIT above).

<rlimit> - repeat limit is an optional integer. It specifies the number of data items that you want returned. It will ignore any additional items beyond that number. You can use the Start offset and the Repeat limit to pick out exactly what part of the data you want to use. The default value is all the data.

Calculate Peaks of Trace Data (Remote Command Only)

Returns a list of all the peaks for the currently selected measurement and sub-opcode [n]. The peaks must meet the requirements of the peak threshold and excursion values.

n = any valid sub-opcode for the current measurement. See the MEASure:<measurement> command description of your specific measurement for information on the data that can be returned.

The command can only be used with specific sub-opcodes with measurement results that are trace data. Both real and complex traces can be searched, but complex traces are converted to magnitude in dBm. In many measurements the sub-opcode n=0, is the raw trace data which cannot be searched for peaks. And Sub-opcode n=1, is often calculated results values which also cannot be searched for peaks.

This command uses the data setting specified by the FORMat:BORDER and FORMat:DATA commands and can return real or ASCII data. If the format is set to INT,32, it returns REAL,32 data.

The command has four types of parameters:

- Threshold (in dBm)
- Excursion (in dB)
- Sorting order (amplitude, frequency, time)
- Optional in some measurements: Display line use (all, > display line, < display line)

Remote Command:

For Swept SA measurement:

```
:CALCulate:DATA [1] | 2 | 3 | 4 | 5 | 6 : PEAKs?
<threshold>, <excursion> [, AMPLitude | FREQuency | TIME [, ALL |
GTDLine | LTDLine] ]
```

For most other measurements:

```
:CALCulate:DATA [1] | 2 | 3 | 4 | 5 | 6 : PEAKs?
<threshold>, <excursion> [, AMPLitude | FREQuency | TIME]
```

Example:

Example for Swept SA measurement in Spectrum Analyzer Mode:

CALC:DATA4:PEAK? -40,10,FREQ,GTDL This will identify the peaks of trace 4 that are above -40 dBm, with excursions of at least 10 dB. The peaks are returned in order of increasing frequency, starting with the lowest frequency. Only the peaks that are above the display line are returned.

Query Results 1:

With FORMat:DATA REAL,32 selected, it returns a list of floating-point numbers. The first value in the list is the number of peak points that are in the following list. A peak point consists of two values: a peak amplitude followed by its corresponding frequency (or time).

If no peaks are found the peak list will consist of only the number of peaks, (0).

Dependencies/Couplings:

Values must be provided for threshold and excursion. The sorting and display line parameters are optional (defaults are AMPLitude and ALL).

Note that there is always a Y-axis value for the display line, regardless of whether the display line state is on or off. It is the current Y-axis value of the display line which is used by this command to determine whether a peak should be reported.

Notes:

<n> - is the trace that will be used

<threshold> - is the level below which trace data peaks are ignored. Note that the threshold value is required and is always used as a peak criterion. To effectively disable the threshold criterion for this command, provide a substantially low threshold value such as -200 dBm. Also note that the threshold value used in this command is independent of and has no effect on the threshold value stored under the Peak Criteria menu.

Notes (Cont.):

<excursion> - is the minimum amplitude variation (rise and fall) required for a signal to be identified as peak. Note that the excursion value is required and is always used as a peak criterion. To effectively disable the excursion criterion for this command, provide the minimum value of 0.0 dB. Also note that the excursion value used in this command is independent of and has no effect on the excursion value stored under the Peak Criteria menu.

Sorting order:

AMPLitude - lists the peaks in order of descending amplitude, with the highest peak first (default if optional parameter not sent)

FREQuency - lists the peaks in order of occurrence, left to right across the x-axis.

TIME - lists the peaks in order of occurrence, left to right across the x-axis.

Peaks vs. Display Line:

ALL - lists all of the peaks found (default if optional parameter not sent).

GTDLIne (greater than display line) - lists all of the peaks found above the display line.

LTDLine (less than display line) - lists all of the peaks found below the display line.

Instrument S/W Revision: Prior to A.02.00

Format Data: Numeric Data (Remote Command Only)

This command specifies the format of the trace data input and output. It specifies the formats used for trace data during data transfer across any remote port. It affects only the data format for setting and querying trace data for the :TRACe[:DATA], TRACe[:DATA]?, :CALCulate:DATA[n]? and FETCh:SANalyzer[n]? commands and queries.

Remote Command: :FORMat [:TRACe] [:DATA] ASCii | INTeger, 32 | REAL, 32 | REAL, 64
:FORMat [:TRACe] [:DATA] ?

Remote Command Notes The query response is:

ASCii: ASC,8

REAL,32: REAL,32

REAL,64: REAL,64

INTeger,32: INT,32

When the numeric data format is REAL or ASCii, data is output in the current Y Axis unit. When the data format is INTeger, data is output in units of m dBm (.001 dBm).

Note that the INT,32 format is only applicable to the command, TRACe:DATA. This preserves backwards compatibility for the Swept SA measurement. For all other commands/queries which honor FORMat:DATA, if INT,32 is sent the analyzer will behave as though it were set to REAL,32.

Remote Command Notes: (Cont.)	The INT,32 format returns binary 32-bit integer values in internal units (m dBm), in a definite length block.
Dependencies/Couplings:	Sending a data format spec with an invalid number (for example, INT,48) generates no error. The analyzer simply uses the default (8 for ASCii, 32 for INTeger, 32 for REAL). Sending data to the analyzer which does not conform to the current FORMat specified, results in an error.
Preset:	ASCii
Instrument S/W Revision:	Prior to A.02.00

The specs for each output type follow:

ASCii - Amplitude values are in ASCII, in the current Y Axis Unit, one ASCII character per digit, values separated by commas, each value in the form:

SX.YYYYYEsZZ

Where:

S = sign (+ or -)

X = one digit to left of decimal point

Y = 5 digits to right of decimal point

E = E, exponent header

s = sign of exponent (+ or -)

ZZ = two digit exponent

REAL,32 - Binary 32-bit real values in the current Y Axis Unit, in a definite length block.

REAL,64 - Binary 64-bit real values in the current Y Axis Unit, in a definite length block.

Format Data: Byte Order (Remote Command Only)

This command selects the binary data byte order for data transfer and other queries. It controls whether binary data is transferred in normal or swapped mode. This command affects only the byte order for setting and querying trace data for the :TRACe[:DATA], TRACe[:DATA]?, :CALCulate:DATA[n]? and FETCh:SANalyzer[n]? commands and queries.

By definition any command that says it uses FORMat:DATA uses any format supported by FORMat:DATA.

The NORMal order is a byte sequence that begins with the most significant byte (MSB) first, and ends with the least significant byte (LSB) last in the sequence: 1|2|3|4. SWAPped order is when the byte sequence begins with the LSB first, and ends with the MSB last in the sequence: 4|3|2|1.

Remote Command:	:FORMat:BORDER NORMal SWAPped :FORMat:BORDER?
Preset:	NORMal
Instrument S/W Revision:	Prior to A.02.00

Meas

Meas Setup

Meas Control features are unique to each Measurement. See the specific Measurement for more information.

Key Path	Front-panel key
Instrument S/W Revision	Prior to A.02.00

Meas Setup

Mode

The Mode key allows you to select the available measurement applications. The application software must be licensed in order for it to be available. Measurement applications are a collection of measurement capabilities packaged together to provide an instrument personality that is specific to your measurement needs. Each application software product is ordered separately by Model Number.

NOTE Key operation can be different between modes. The information displayed in Help is about the current mode.

To access Help for a different Mode you must first exit Help (by pressing the Cancel (Esc) key). Then select the desired mode and re-access Help.

Once an instrument mode is selected, only the commands that are valid for that mode can be executed. A list of the valid mode choices is returned with the INST:CAT? Query.

It is possible to specify the order in which the Modes appear in the Mode menu, using the Configure Applications utility (**System, Power On, Configure Applications**). It is also possible, using the same utility, to specify a subset of the available applications to load at startup time, which can significantly decrease the startup time of the analyzer. If this is done, then during runtime, if an application which is not loaded into memory is selected by you using the Mode menu or by sending SCPI commands, there will be a significant pause while the Application is loaded. During this pause a message box which says “Loading application ...” is displayed.

Remote Command	:INSTrument [:SElect] SA BASIC ADEMOD NFIGURE PNOISE CDMA2K TDSCDMA VSA VSA89 601 WCDMA WIMAXOFDMA EDGE GSM CDMA1XEV RLC :INSTrument [:SElect] ?
Example	:INST SA
Remote Command Notes	The available parameters are dependent upon installed and licensed applications resident in the instrument. Parameters given here are an example, specific parameters are in the individual Application. Once an instrument mode is selected, only the commands that are valid for that mode can be executed.
Key Path	Front-panel key
Preset	Not affected by Preset. Set to SA following Restore System Defaults, if SA is the default mode.
State Saved	Saved in state
Instrument S/W Revision	Prior to A.02.00

Mode

Application Mode Number Selection (Remote Command only)

Select the measurement mode by its mode number. The actual available choices depend upon which applications are installed in your instrument. The modes appear in this table by NSEL number, which is not the same as their order in the Mode menu (see “Detailed List of Modes” on page 556 for the mode order).

Mode	:INSTRument:NSElect <integer>	:INSTRument[:SElect] <parameter>
Spectrum Analyzer	1	SA
I/Q Analyzer (Basic)	8	BASIC
WCDMA with HSDPA/HSUPA	9	WCDMA
cdma2000	10	CDMA2K
GSM/EDGE/EDGE Evo	13	EDGE GSM
Phase Noise	14	PNOISE
1xEV-DO	15	CDMA1XEV
Combined WLAN	19	CWLAN
802.16 OFDMA (WiMAX/WiBro)	75	WIMAXOFDMA
Combined Fixed WiMAX	81	CWIMAXOFDM
Vector Signal Analyzer (VXA)	100	VSA
89601 VSA	101	VSA89601
LTE	102	LTE
iDEN/WiDEN/MotoTalk	103	IDEN
802.16 OFDM (Fixed WiMAX)	104	WIMAXFIXED
TD-SCDMA with HSPA/8PSK	211	TDSCDMA
Noise Figure	219	NFIGURE
Analog Demod	234	ADEMOD
DVB-T/H	235	DVB
DTMB	236	DTMB
Remote Language Compatibility	266	RLC

Remote Command: :INSTRument:NSElect <integer>
:INSTRument:NSElect?

Example: :INST:NSEL 1

Remote Command Notes:	SA mode is 1 The command must be sequential: i.e. continued parsing of commands cannot proceed until the instrument select is complete and the resultant SCPI trees are available.
Preset:	Not affected by Preset. Set to default mode (1 for SA mode) following Restore System Defaults.
State Saved:	Saved in state
Instrument S/W Revision:	Prior to A.02.00

Application Mode Catalog Query (Remote Command only)

Returns a string containing a comma separated list of names of all the installed and licensed measurement modes (applications). These names can only be used with the :INSTRument[:SElect] command.

Remote Command:	:INSTRument :CATalog?
Example:	:INST:CAT?
Remote Command Notes:	Query returns a quoted string of the installed and licensed modes separated with a comma. Example: "SA,PNOISE,WCDMA"
Instrument S/W Revision:	Prior to A.02.00

Application Identification (Remote Commands only)

Each entry in the Mode Menu will have a Model Number and associated information: Version, and Options.

This information is displayed in the Show System screen. The corresponding SCPI remote commands are defined here.

Current Application Model

Returns a string which is the Model Number of the currently selected application (mode).

Remote Command:	:SYSTem:APPLication[:CURRent] [:NAME]?
Example:	:SYST:APPL?
Remote Command Notes:	Query returns a quoted string which is the Model Number of the currently selected application (Mode). Example: "N9060A" String length is 6 characters.
Preset:	Not affected by Preset

Mode

State Saved: Not saved in state, the value will be the selected application when Save is done.

Instrument S/W Revision: Prior to A.02.00

Current Application Revision

Returns a string which is the Revision of the currently selected application (mode).

Remote Command: :SYSTem:APPLication[:CURRent]:REVision?

Example: :SYST:APPL:REV?

Remote Command Notes: Query returns a quoted string which is the Revision of the currently selected application (Mode). Example:

"1.0.0.0"

String length is a maximum of 23 characters. (each numeral can be an integer + 3 decimal points)

Preset: Not affected by Preset

State Saved: Not saved in state, the value will be the selected application when Save is done.

Instrument S/W Revision: Prior to A.02.00

Current Application Options

Returns a string which is the Options list of the currently selected application (mode).

Remote Command: :SYSTem:APPLication[:CURRent]:OPTion?

Remote Command Notes: Query returns a quoted string which is the Option list of the currently selected application (Mode). The format is the name as the *OPT? or SYSTem:OPTion command: a comma separated list of option identifiers. Example:

"1FP,2FP"

String length is a maximum of 255 characters.

Preset: Not affected by Preset

State Saved: Not saved in state per se, value will be the selected application when Save is invoked

Example: :SYST:APPL:OPT?

Instrument S/W Revision: Prior to A.02.00

Application Identification Catalog (Remote Commands only)

A catalog of the installed and licensed applications (Modes) can be queried for their identification.

Application Catalog number of entries

Returns the number of installed and licensed applications (Modes).

Remote Command:	:SYSTem:APPLication:CATalog[:NAME]:COUNT?
Example:	:SYST:APPL:CAT:COUN?
Preset:	Not affected by Preset
State Saved:	Not saved in state.
Instrument S/W Revision:	Prior to A.02.00

Application Catalog Model Numbers

Returns a list of Model Numbers for the installed and licensed applications (Modes).

Remote Command:	:SYSTem:APPLication:CATalog[:NAME]?
Example:	:SYST:APPL:CAT?
Remote Command Notes:	Returned value is a quoted string of a comma separated list of Model Numbers. Example, if SAMS and Phase Noise are installed and licensed: "N9060A,N9068A" String length is COUNT * 7 - 1. (7 = Model Number length + 1 for comma. -1 = no comma for the 1st entry.)
Preset:	Not affected by Preset
State Saved:	Not saved in state.
Instrument S/W Revision:	Prior to A.02.00

Application Catalog Revision

Returns the Revision of the provided Model Number.

Remote Command:	:SYSTem:APPLication:CATalog:REVision? <model>
Example:	:SYST:APPL:CAT:REV? 'N9060A'
Remote Command Notes:	Returned value is a quoted string of revision for the provided Model Number. The revision will be a null-string ("") if the provided Model Number is not installed and licensed. Example, if SAMS is installed and licensed: "1.0.0.0"
Preset:	Not affected by Preset
State Saved:	Not saved in state.
Instrument S/W Revision:	Prior to A.02.00

Mode

Application Catalog Options

Returns a list of Options for the provided Model Number

Remote Command:	:SYSTem:APPLication:CATalog:OPTion? <model>
Example:	:SYST:APPL:CAT:OPT? 'N9060A'
Remote Command Notes:	Returned value is a quoted string of a comma separated list of Options, in the same format as *OPT? or :SYSTem:OPTion?. If the provided Model Number is not installed and licensed a null-string (") will be returned. Example, if SAMS is installed and licensed: "2FP" String length is a maximum of 255 characters.
Preset:	Not affected by Preset
State Saved:	Not saved in state.
Instrument S/W Revision:	Prior to A.02.00

Detailed List of Modes

Spectrum Analyzer

Selects the Spectrum Analyzer mode for general purpose measurements. There are several measurements available in this mode. General spectrum analysis measurements, in swept and zero span, can be done using the first key in the Meas menu, labeled Swept SA. Other measurements in the Meas Menu are designed to perform specialized measurement tasks, including power and demod measurements.

If you are using the Help feature, this mode must be currently active to access its detailed information. If it is not active, exit the Help feature (Esc key), select the mode, and re-access Help.

Example	INST:SEL SA INST:NSEL 1
Key Path	Mode
Instrument S/W Revision	Prior to A.02.00

IQ Analyzer (Basic)

The IQ Analyzer Mode makes general purpose frequency domain and time domain measurements. These measurements often use alternate hardware signal paths when compared with a similar measurement in the Signal Analysis Mode using the Swept SA measurement. These frequency domain and time domain measurements can be used to output I/Q data results when measuring complex modulated digital signals.

If you are using the Help feature, this mode must be currently active to access its detailed information. If it is not active, exit the Help feature (Esc key), select the mode, and re-access Help.

Example	INST:SEL BASIC INST:NSEL 8
Key Path	Mode
Instrument S/W Revision	Prior to A.02.00

W-CDMA with HSDPA/HSUPA

Selects the W-CDMA with HSDPA/HSUPA mode for general purpose measurements of signals following this standard. There are several measurements available in this mode.

If you are using the Help feature, this mode must be currently active to access its detailed information. If it is not active, exit the Help feature (Esc key), select the mode, and re-access Help.

Example	INST:SEL WCDMA INST:NSEL 9
Key Path	Mode
Instrument S/W Revision	Prior to A.02.00

GSM/EDGE/EDGE Evo

Selects the GSM with EDGE mode for general purpose measurements of signals following this standard. There are several measurements available in this mode.

If you are using the Help feature, this mode must be currently active to access its detailed information. If it is not active, exit the Help feature (Esc key), select the mode, and re-access Help.

Example	INST:SEL EDGEGSM INST:NSEL 13
Key Path	Mode
Instrument S/W Revision	Prior to A.02.00
Modified at S/W Revision	A.02.00

Mode

802.16 OFDMA (WiMAX/WiBro)

Selects the OFDMA mode for general purpose measurements of WiMAX signals. There are several measurements available in this mode.

If you are using the Help feature, this mode must be currently active to access its detailed information. If it is not active, exit the Help feature (Esc key), select the mode, and re-access Help.

Example INST:SEL WIMAXOFDMA
 INST:NSEL 75

Key Path **Mode**

Instrument S/W Revision Prior to A.02.00

Vector Signal Analyzer (VXA)

The 89601X Vector Signal Analyzer provides vector-signal analysis measurement capability. It provides 3 main measurements that allow you to measure the signal quality of all varieties of RF modulation:

- Digital Demodulation
- Analog Demodulation
- Vector Signal Analysis

There are advanced modulation analysis and troubleshooting capabilities including the following communications formats: AM, FM, PM, WiMAX, W-CDMA, 2G, 3G, 3.5G, WLAN, digital video, and more. It also provides standard-specific measurements for analysis of iDEN, WiDEN, and MotoTalk signals with Option H09.

If you are using the Help feature, this mode must be currently active to access its detailed information. If it is not active, exit the Help feature (Esc key), select the mode, and re-access Help.

Example INST:SEL VSA
 INST:NSEL 100

Key Path **Mode**

Instrument S/W Revision Prior to A.02.00

Phase Noise

The Phase Noise mode provides pre-configured measurements for making general purpose measurements of device phase noise.

If you are using the Help feature, this mode must be currently active to access its detailed information. If it is not active, exit the Help feature (Esc key), select the mode, and re-access Help.

Example INST:SEL PNOISE
 or
 INST:NSEL 14

Key Path	Mode
Instrument S/W Revision	Prior to A.02.00

Noise Figure

The Noise Figure mode provides pre-configured measurements for making general purpose measurements of device noise figure.

If you are using the Help feature, this mode must be currently active to access its detailed information. If it is not active, exit the Help feature (Esc key), select the mode, and re-access Help.

Example	INST:SEL NFIGURE
	Or
	INST:NSEL 219

Key Path	Mode
Instrument S/W Revision	Prior to A.02.00

Analog Demod

Selects the Analog Demod mode for making measurements of AM, FM and phase modulated signals.

If you are using the Help feature, this mode must be currently active to access its detailed information. If it is not active, exit the Help feature (Esc key), select the mode, and re-access Help.

Example	INST:SEL ADEMOM
	INST:NSEL 234

Key Path	Mode
Instrument S/W Revision	Prior to A.02.00

TD-SCDMA with HSPA/8PSK

Selects the TD-SCDMA mode for general purpose measurements of signals following this standard. There are several measurements available in this mode.

If you are using the Help feature, this mode must be currently active to access its detailed information. If it is not active, exit the Help feature (Esc key), select the mode, and re-access Help.

Example	INST:SEL TDSCDMA
	INST:NSEL 211

Key Path	Mode
Instrument S/W Revision	Prior to A.02.00

Mode

cdma2000

Selects the cdma2000 mode for general purpose measurements of signals following this standard. There are several measurements available in this mode.

If you are using the Help feature, this mode must be currently active to access its detailed information. If it is not active, exit the Help feature (Esc key), select the mode, and re-access Help.

Example INST:SEL CDMA2K
 INST:NSEL 10

Key Path **Mode**

Instrument S/W Revision Prior to A.02.00

1xEV-DO

Selects the 1xEV-DO mode for general purpose measurements of signals following this standard. There are several measurements available in this mode.

If you are using the Help feature, this mode must be currently active to access its detailed information. If it is not active, exit the Help feature (Esc key), select the mode, and re-access Help.

Example INST:SEL CDMA1XEV
 INST:NSEL 15

Key Path **Mode**

Instrument S/W Revision Prior to A.02.00

LTE

Selects the LTE mode for general purpose measurements of signals following this standard. There are several measurements available in this mode.

If you are using the Help feature, this mode must be currently active to access its detailed information. If it is not active, exit the Help feature (Esc key), select the mode, and re-access Help.

Example INST:SEL LTE
 INST:NSEL 102

Key Path **Mode**

Instrument S/W Revision Prior to A.02.00

DVB-T/H

Selects the DVB-T/H mode for measurements of digital video signals using this format. There are several power and demod measurements available in this mode.

If you are using the Help feature, this mode must be currently active to access its detailed information. If it is not active, exit the Help feature (Esc key), select the mode, and re-access Help.

Example	INST:SEL DVB INST:NSEL 235
Key Path	Mode
Instrument S/W Revision	A.02.00

DTMB

Selects the DTMB mode for measurements of digital video signals using this format. There are several power and demod measurements available in this mode.

If you are using the Help feature, this mode must be currently active to access its detailed information. If it is not active, exit the Help feature (Esc key), select the mode, and re-access Help.

Example	INST:SEL DTMB INST:NSEL 236
Key Path	Mode
Instrument S/W Revision	A.02.00

Combined WLAN

Selects the CWLAN mode for general purpose measurements of signals following this standard. There are several measurements available in this mode.

If you are using the Help feature, this mode must be currently active to access its detailed information. If it is not active, exit the Help feature (Esc key), select the mode, and re-access Help.

Example	INST:SEL CWLAN INST:NSEL 19
Key Path	Mode
Instrument S/W Revision	A.02.00

Mode

Combined Fixed WiMAX

Selects the Combined Fixed WiMAX mode for general purpose measurements of signals following this standard. There are several measurements available in this mode.

If you are using the Help feature, this mode must be currently active to access its detailed information. If it is not active, exit the Help feature (Esc key), select the mode, and re-access Help.

Example	INST:SEL CWIMAXOFDM INST:NSEL 81
Key Path	Mode
Instrument S/W Revision	A.02.00

802.16 OFDM (Fixed WiMAX)

Selects the 802.16 OFDM (Fixed WiMAX) mode. This mode allows modulation quality measurements of signals that comply with IEEE 802.16a–2003 and IEEE 802.16–2004 standards, with flexibility to measure nonstandard OFDM formats. Along with the typical digital demodulation measurement results, several additional 802.16 OFDM unique trace data formats and numeric error data results provide enhanced data analysis.

If you are using the Help feature, this mode must be currently active to access its detailed information. If it is not active, exit the Help feature (Esc key), select the mode, and re-access Help.

Key Path	Mode
Example	INST:SEL WIMAXFIXED INST:NSEL 104
Instrument S/W Revision	A.02.00

iDEN/WiDEN/MOTOTalk

Selects the iDEN/WiDEN/MOTOTalk mode for general purpose measurements of iDEN and iDEN-related signals. There are several measurements available in this mode.

If you are using the Help feature, this mode must be currently active to access its detailed information. If it is not active, exit the Help feature (Esc key), select the mode, and re-access Help.

Example	INST:SEL IDEN INST:NSEL 103
Key Path	Mode
Instrument S/W Revision	A.02.00

Remote Language Compatibility

The Remote Language Compatibility (RLC) mode provides remote command backwards compatibility for the 8560 series of spectrum analyzers, known as legacy spectrum analyzers.

NOTE After changing into or out of RLC mode, allow a 1 second delay before sending any subsequent commands.

If you are using the Help feature, this mode must be currently active to access its detailed information. If it is not active, exit the Help feature (Esc key), select the mode, and re-access Help.

Example	INST:SEL RLC
	Or
	INST:NSEL 266
Key Path	Mode
Instrument S/W Revision	Prior to A.02.00

89601 VSA

Selecting the 89601 VSA mode will start the 89600-Series VSA software application. The 89600 VSA software is powerful, PC-based software, offering the industry's most sophisticated general purpose and standards specific signal evaluation and troubleshooting tools for the R&D engineer. Reach deeper into signals, gather more data on signal problems, and gain greater insight.

- Over 30 general-purpose analog and digital demodulators ranging from 2FSK to 1024QAM
- Standards specific modulation analysis including:
- Cell: GSM, cdma2000, WCDMA, TD-SCDMA and more
- Wireless networking: 802.11a/b/g, 802.11n, 802.16 WiMAX (fixed/mobile), UWB
- RFID
- Digital satellite video and other satellite signals, radar, LMDS
- Up to 400K bin FFT, for the highest resolution spectrum analysis
- A full suite of time domain analysis tools, including signal capture and playback, time gating, and CCDF measurements
- Six simultaneous trace displays and the industry's most complete set of marker functions
- Easy-to-use Microsoft ® Windows ® graphical user interface

Mode

For more information see the Agilent 89600 Series VSA web site at www.agilent.com/find/89600

To learn more about how to use the 89600 VSA running in the MXA, after the 89600 VSA application is running, open the 89600 VSA Help and open the "About Agilent X-Series Signal Analyzers (MXA/EXA) with 89600-Series Software" help topic.

Example	INST:SEL VSA89601 INST:NSEL 101
Key Path	Mode
Instrument S/W Revision	Prior to A.02.00

Mode Setup

There is only one key in the Mode Setup menu for the Phase Noise application. It is the Restore Mode Defaults key.

Key Path	Front-panel key
Instrument S/W Revision	Prior to A.02.00

Restore Mode Defaults

Restore Mode Defaults resets the state for the currently active mode by resetting the mode persistent settings to their factory default values, clearing mode data and by performing a Mode Preset

Key Path	Mode Setup
Instrument S/W Revision	Prior to A.02.00

Mode Setup

Peak Search

Pressing the Peak Search key displays the Peak Search menu and places the selected marker on the trace point with the maximum y-axis value for that marker's trace. The Peak Search features allow you to define specific search criteria to determine which signals can be considered peaks, excluding unwanted signals from the search.

If **Same as "Next Peak" Criteria** is selected, and either **Pk Excursion** or **Pk Threshold** are on, a signal must meet those criteria. If no valid peak is found, a message is generated and the marker is not moved. When **Highest Peak** is on, or both **Pk Excursion** and **Pk Threshold** are off, the marker is always placed at the point on the trace with the maximum y-axis value, even if that point is on the very edge of the trace (exception: negative frequencies and signals close to the LO are not searched at all).

Pressing Peak Search with the selected marker off causes the selected marker to be set to **Normal** at the center of the screen, then a peak search is immediately performed.

Key Path	Front-panel key
Instrument S/W Revision	Prior to A.02.00

Peak Search

Recall

Recall functionality is common across multiple Modes and Measurements. These common features are described in this section.

The Recall feature prompts you to answer the questions: What do you want to recall? And to where do you want to recall it? Once these questions are answered the recall can occur. The options in this menu answer the question "What do you want to Recall?"

The options are State, Trace and Data. (Screen Image can be saved, but not recalled.) The default paths for Recall are data type dependent and are the same as for Save.

Remote Command Notes	No remote command directly controls the Recall Type that this key controls. The Recall type is a node in the :MMEM:LOAD command. An example is :MMEM:LOAD:STATe <filename>.
Key Path	Front-panel key
Instrument S/W Revision	Prior to A.02.00

State

Accesses a menu that enables you to recall a State that has previously been saved. Recalling a saved state returns the analyzer as close as possible to the mode context and may cause a mode switch if the file selected is not for the current active mode. A State file can be recalled from either a register or a file. Once you pick the source of the recall in the State menu, the recall will occur.

When this key is pressed, you have determined what they want to recall is **State**. Recalling **State** is used to return as close as possible to the mode context of the save. Recalling State may cause a mode switch if the file selected is not for the currently active mode. This menu key will not actually cause the recall, since the recall feature still needs to know from where to recall the state. **State** can be recalled from either a register or a file. Pressing this key will bring up the State menu that provides you with the option of where to retrieve the state. For quick recalls, the State menu lists 6 registers to recall from or you can select a file to recall from.

Example	MMEM:LOAD:STAT "MyStateFile.state" This loads the state file data (on the default file directory path) into the instrument state.
Remote Command Notes	See "Open" on page 572 .
Key Path	Recall
Mode	All
Instrument S/W Revision	Prior to A.02.00

In measurements that support saving Traces, for example, Swept SA, the Trace data is saved along with the State in the State file. When recalling the State, the Trace data is recalled as well. Traces are recalled exactly as they were stored, including the writing mode and update and display modes; so if a Trace was

Recall

updating and visible when the State was saved, it will come back updating and visible; hence its data will be rewritten right away. So if using State to save and recall traces, any trace whose data must be preserved should be placed in View or Blank before saving.

This creates the following table describing the Trace Save/Recall possibilities:

You want to recall state and one trace's data, leaving other traces unaffected.	Save Trace+State from 1 trace. Make sure that no other traces are updating (they should all be in View or Blank) when the save is performed.	On Recall, specify the trace you want to load the one trace's data into. This trace will load in View. All other traces' data will be unaffected, although their trace mode will be as it was when the state save was performed.
You want to recall all traces	Save Trace+State from ALL traces.	On Recall, all traces will come back in View (or Blank if they were in Blank or Background when saved)
You want all traces to load exactly as they were when saved.	Save State	On recall, all traces' mode and data will be exactly as they were when saved. Any traces that were updating will, of course, have their data immediately overwritten.

Register 1 thru Register 6

Selecting any one of these register keys causes the State of the mode from the specified Register to be recalled. Each of the register keys annotates whether it is empty or at what date and time it was last modified.

Registers are shared by all modes, so recalling from any one of the 6 registers may cause a mode switch to the mode that was active when the save to the Register occurred.

After the recall completes, the message "Register <register number> recalled" appears in the message bar.

Selecting any one of these register menu keys: **Register 1**, **Register 2**, **Register 3**, **Register 4**, **Register 5**, **Register 6** causes the state of the mode from the specified Register to be recalled. The registers are provided for easy saving and recalling, since you do not have to specify a filename or navigate to a specific file. The date will follow the format specified in the Date Format setting under the **Control Panel**. The time will show hours, minutes and seconds.

Example	*RCL 1
Key Path	Recall, State
Readback	Date and time with seconds resolution of the last Save is displayed on the key, or "(empty)" if no prior save operation performed to this register.
Instrument S/W Revision	Prior to A.02.00

Example	*RCL 2
Key Path	Recall, State
Readback	Date and time with seconds resolution of the last Save is displayed on the key, or "(empty)" if no prior save operation performed to this register.
Instrument S/W Revision	Prior to A.02.00

Example	*RCL 3
Key Path	Recall, State
Readback	Date and time with seconds resolution of the last Save is displayed on the key, or "(empty)" if no prior save operation performed to this register.
Instrument S/W Revision	Prior to A.02.00

Example	*RCL 4
Key Path	Recall, State
Readback	Date and time with seconds resolution of the last Save is displayed on the key, or "(empty)" if no prior save operation performed to this register.
Instrument S/W Revision	Prior to A.02.00

Example	*RCL 5
Key Path	Recall, State
Readback	Date and time with seconds resolution of the last Save is displayed on the key, or "(empty)" if no prior save operation performed to this register.
Instrument S/W Revision	Prior to A.02.00

Example	*RCL 6
Key Path	Recall, State
Readback	Date and time with seconds resolution of the last Save is displayed on the key, or "(empty)" if no prior save operation performed to this register.
Instrument S/W Revision	Prior to A.02.00

From File\ File Open

Brings up the File Open standard Windows® dialog and its corresponding **File Open** key menu.

When you first enter this dialog, the State File default path is in the Look In: box in this File Open dialog. The File Open dialog is loaded with the file information related to the State Save Type. The first *.state file is highlighted. The only files that are visible are the *.state files and the Files of type is *.state, since .state is the file suffix for the State Save Type. For more details, refer to [“File Open Dialog and Menu”](#) on

Recall

page 586.

Restriction and Notes	Brings up Open dialog for recalling a State Save Type
Key Path	Recall, State
Instrument S/W Revision	Prior to A.02.00

Open

Recalling State function first must verify the file is recallable in the current instrument by checking the software version and model number of the instrument. If everything matches, a full recall proceeds by aborting the currently running measurement, and then loading the State from the saved state file to as close as possible to the context in which the save occurred. You can open state files from any mode, so recalling a State File switches to the mode that was active when the save occurred. After switching to the mode of the saved state file, mode settings and data (if any for the mode) are loaded with values from the saved file. The saved measurement of the mode becomes the newly active measurement and the data relevant to the measurement (if there is any) is recalled.

If there is a mismatch between file version or model number or instrument version or model number, the recall still tries to recall as much as possible and it returns a warning message of what it did.

NOTE No Trace data is loaded when recalling a State File. Measurements that support loading of trace data will include a Trace key in the Recall menu and will load State + Trace data from .trace files under that key.

Remote Command:	:MMEMory:LOAD:STATe <filename>
Example:	:MMEM:LOAD:STAT "myState.state" recalls the file myState.state on the default path
Restriction and Notes:	Auto return to the State menu and the Open dialog goes away. Advisory Event "Recalled File <file name>" after recall is complete.
Remote Command Notes:	Although the trace data is included in the .state file it is not recalled; that is left for .trace files only for measurements that support recalling of trace data. Errors are generated if the specified file is empty or does not exist, or there is a file type mismatch.
Key Path:	Recall, State, From File...
Instrument S/W Revision:	Prior to A.02.00

The state of a mode includes all of the variables affected by doing a full preset. It not only recalls Mode Preset settings, but it also recalls all of the mode persistent settings and data if the mode has either. Each mode determines whether data is part of mode state and if the mode has any persistent settings. **Recall State** also recalls all of the **Input/Output** system settings, since they are saved with each State File for each mode.

The Recall State function does the following:

- Verifies that the file is recallable on this instrument using the version number and model number.
- Aborts the currently running measurement.
- Clears any pending operations.
- Switches to the mode of the selected Save State file.
- Sets mode State and Input/Output system settings to the values in the selected Saved State file.
- Limits settings that differ based on model number, licensing or version number.
- Makes the saved measurement for the mode the active measurement.
- Clears the input and output buffers.
- Status Byte is set to 0.
- Executes a *CLS

Trace (+State)

When this key is pressed, you have determined what you want to recall is **Trace**. Trace files include the state of the mode they were saved from as well as the trace data, with internal flags to indicate which trace you were trying to save which may include ALL traces. They are otherwise identical to State files. Recalling **Trace** may cause a mode switch if the file selected is not for the currently active mode.

Not all modes support saving of trace data with the state; and for modes that do, not all measurements do. The Trace key is grayed out for measurements that do not support trace recall. It is blanked for modes that do not support trace recall.

This key will not actually cause the recall, since the recall feature still needs to know from which file to recall the trace and which trace to recall it into. Pressing this key will bring up the Recall Trace menu that provides you with the option of where to retrieve the trace.

For quick recalls, the Trace menu lists 5 registers to recall from or you can select a file to recall from.

Example	MMEM:LOAD:TRAC TRACE2,"MyTraceFile.trace" !This loads the trace file data (on the default file directory path) into the specified trace. :MMEM:LOAD:TRAC:REG TRACE1,2 ! restores the trace data in register 2 to Trace 1
Key Path	Recall
Mode	SA
Instrument S/W Revision	Prior to A.02.00

Recall

Register 1 thru Register 5

Selecting any one of these register keys causes the Traces and State from the specified Register to be recalled. Each of the register keys annotates whether it is empty or at what date and time it was last modified.

Trace registers are shared by all modes, so recalling from any one of the 5 registers may cause a mode switch to the mode that was active when the save to the Register occurred.

After the recall completes, the message "Trace Register <register number> recalled" appears in the message bar.

Selecting any one of these register menu keys: **Register 1, Register 2, Register 3, Register 4, Register 5** causes the traces and state of the mode from the specified Register to be recalled. The registers are provided for easy saving and recalling, since you do not have to specify a filename or navigate to a specific file. The date will follow the format specified in the Date Format setting under the **Control Panel**. The time will show hours, minutes and seconds.

Key Path	Recall, Trace
Readback	Date and time with seconds resolution of the last Save is displayed on the key, or "(empty)" if no prior save operation performed to this register.
Instrument S/W Revision	Prior to A.02.00
Key Path	Recall, Trace
Readback	Date and time with seconds resolution of the last Save is displayed on the key, or "(empty)" if no prior save operation performed to this register.
Instrument S/W Revision	Prior to A.02.00
Key Path	Recall, Trace
Readback	Date and time with seconds resolution of the last Save is displayed on the key, or "(empty)" if no prior save operation performed to this register.
Instrument S/W Revision	Prior to A.02.00
Key Path	Recall, Trace
Readback	Date and time with seconds resolution of the last Save is displayed on the key, or "(empty)" if no prior save operation performed to this register.
Instrument S/W Revision	Prior to A.02.00
Key Path	Recall, Trace
Readback	Date and time with seconds resolution of the last Save is displayed on the key, or "(empty)" if no prior save operation performed to this register.
Instrument S/W Revision	Prior to A.02.00

To Trace

These key selections let you pick which Trace to recall the saved trace into; either 1, 2, 3, 4, 5, or 6. Not all modes have the full 6 traces available. The default is the currently selected trace, selected in this menu or in the Trace/Det, Export Data, Import Data, or Save Trace menus, except if you have chosen All then it remains chosen until you specifically change it to a single trace.

If the .trace file is an "all trace" file, "To Trace" is ignored and the traces each go back to the trace they were saved from.

Once selected, the key returns back to the Recall Trace menu and the selected Trace number is annotated on the key. Now you have selected exactly where the trace needs to be recalled. In order to trigger a recall of the selected Trace, you must select the **Open** key in the Recall Trace menu.

Key Path	Save, Data, Trace
Mode	SA
Instrument S/W Revision	Prior to A.02.00

Open...

Pressing **Open** brings up the File Open standard Windows dialog and its corresponding File Open key menu. When you navigate to this selection, they have already determined they are recalling Trace and now they want to specify from which file to do the recall.

When you first enter this dialog, the State File default path is in the Look In: box in this File Open dialog. The File Open dialog is loaded with the file information related to the State Save Type. The first *.trace file is highlighted. Also, the only files that are visible are the *.trace files and the Files of type is *.trace, since .trace is the file suffix for the Trace Save Type. For more details, refer to ["File Open Dialog and Menu" on page 586](#).

Restriction and Notes	Brings up Open dialog for recalling a Trace Save Type
Key Path	Recall, Trace
Mode	SA
Instrument S/W Revision	Prior to A.02.00

Open

Recalling Trace first must verify the file is recallable in this instrument by checking instrument software version and model number, since it includes State. If everything matches, a full recall proceeds by aborting the currently running measurement, loads the state from the saved state file to as close as possible to the context in which the save occurred. Users can open .trace files from any mode that supports them, so recalling a Trace File switches to the mode that was active when the save occurred. After switching to the mode of the saved state file, mode settings and data (if any for the mode) are loaded with values from the saved file and the saved measurement of the mode becomes the newly active measurement and the data relevant to the measurement (if there is any) is recalled.

Once the state is loaded the trace data must be loaded. The internal flags are consulted to see which trace to load and the "To Trace" setting to see where to load it. Trace data is always loaded with the specified trace set to View, so that the data is visible and not updating (so as not to wipe out the recalled data). If

Recall

the file is an "all trace" file, all traces are loaded with the saved data (to the original trace the data was saved from) and set to View. Traces whose data is not loaded are restored to the update state that existed when they were saved.

In every other way a Trace load is identical to a State load. See section "Open" on page 572 for details.

Restriction and Notes	Auto return to the Trace menu and the Open dialog goes away. Advisory Event "Recalled File <file name>" after recall is complete.
Remote Command	<code>:MMEMory:LOAD:TRACe</code> <code>TRACE1 TRACE2 TRACE3 TRACE4 TRACE5 TRACE6,<filename></code> <code>:MMEMory:LOAD:TRACe:REGister</code> <code>TRACE1 TRACE2 TRACE3 TRACE4 TRACE5 TRACE6,<integer></code>
Remote Command Notes	Some modes and measurements do not have available all 6 traces. Phase Noise mode command, for example, is: <code>MMEMory:LOAD:TRACe</code> <code>TRACE1 TRACE2 TRACE3,<filename></code> The load trace command actually performs a load state, which in the Swept SA measurement includes the trace data. However it looks in the recalled state file to see how it was flagged at save time. The possibilities are: If the trace file was saved using one of the TRACE# enums, it is flagged as a single trace save file. The trace that was flagged as the one that was saved, is loaded to the trace specified. The trace is loaded with update off and display on, and none of the other traces are loaded. If the trace file was saved using one the ALL enum, it is flagged as an "all traces" file. And all traces will be loaded. All of the traces are loaded with Update=Off to keep them from updating, regardless of the setting of "Recall State w/Trace Update".
Example	<code>:MMEM:LOAD:TRAC TRACE2,"myState.trace"</code> recalls the file myState.trace on the default path; if it is a "single trace" save file, that trace is loaded to trace 2, and will is set to be not updating. <code>:MMEM:LOAD:TRAC:REG TRACE1,2</code> restores the trace data in register 2 to Trace 1
Key Path	Recall, Trace, Open...
Instrument S/W Revision	Prior to A.02.00

Data (Mode Specific)

Importing a data file loads data that was previously saved from the current measurement or from other measurements and/or modes that produce the same type of data. The Import Menu only contains Data Types that are supported by the current measurement.

For any given mode, the Export Data and Import Data menus match, but keys in Import Data are blanked if the data type is supported for Save but not for Recall.

Since the commonly exported data files are in .csv format, the data can be edited by you prior to importing. This allows you to export a data file, manipulate the data in Excel (the most common PC Application for manipulating .csv files) and then import it.

Importing Data loads measurement data from the specified file into the specified or default destination, depending on the data type selected. Selecting an Import Data menu key will not actually cause the importing to occur, since the analyzer still needs to know from where to get the data. Pressing the Open key in this menu brings up the Open dialog and Open menu that provides you with the options from where to recall the data. Once a filename has been selected or entered in the Open menu, the recall will occur as soon as the Open key is pressed. See section “[File Open Dialog and Menu](#)” on page 586 for more details.

Remote Command Notes	No SCPI command directly controls the Data Type that this key controls. The Data Type is included in the MMEM:LOAD commands.
Key Path	Recall
Mode	SA VSA
Preset	<mode specific>; Is not affected by Preset, but is reset during Restore Mode Defaults and survives subsequent running of the mode
Readback	SA: Trace 1 Trace 2 Trace 3 Trace 4 Trace 5 Trace 6 VSA: Trace to Data 1 Trace to Data 2 Trace to Data 3 Trace to Data 4 Trace to Data 5 Trace to Data 6
Instrument S/W Revision	Prior to A.02.00

Trace

This key selects the Traces as the data type to be imported with this recall request. It brings up the Trace Menu that lets you select which Trace to import the data into.

This key is grayed out when measurements are running that do not support trace importing.

For Vector Signal Analyzer Mode:

the trace data is loaded into the selected data register. Trace data registers are temporary storage places for trace data. They allow you to view past results next to current measurement results, and are also used in some functions like user defined filters. They are measurement global, so you can import data into a register while in the Digital Demod measurement and view it later while in the Vector measurement. Data registers are cleared when the measurement application is terminated, but not when you change Modes and return.

If the recalled file was saved with header information, the trace will initially be displayed with the same formatting and scaling as it had when it was saved. If headers are not saved, the scaling and format are set to defaults when the trace is recalled.

The following trace data formats may be imported:

- Text and comma-separated variable (CSV)

- Text

- SDF.

Recall

Option 200 also allows import of these additional formats:

Matlab 4

Matlab 5

Matlab HDF5

N5110A compatible binary

Example	MMEM:LOAD:TRAC:DATA TRACE2,"MyTraceFile.csv" This loads the trace file data (on the default file directory path) into the specified trace.
Dependencies/Couplings	Trace data is not available from all Measurements. In that case, the key will be grayed out. The key will not show if no measurements in the Mode support it. For SA measurements, traces cannot be recalled from a trace file that was saved with ALL traces selected.
Key Path	Recall, Data
Mode	SA Analog Demod VSA
Preset	1; not part of Preset, but is reset by Restore Mode Defaults and survives power cycles
State Saved	Saved in State
Readback	selected Trace table
Readback	SA: 1 2 3 4 5 6 VSA: Data 1 Data 2 Data 3 Data 4 Data 5 Data 6
Instrument S/W Revision	Prior to A.02.00

Trace 1, 2, 3, 4, 5, 6

These keys let you pick which Trace to import the data into; either 1, 2, 3, 4, 5 or 6. The default is the currently selected trace, selected in this menu or in the Trace/Det, Export Data, Recall Trace, or Save Trace menus, except if you have chosen All then it remains chosen until you specifically change it to a single trace.

Once selected, the key returns back to the Import Data menu and the selected Trace number is annotated on the key. Now you have selected exactly what needs to be imported. In order to trigger a import of the selected trace, you must select the Open key in the Import Data menu.

An example of using this menu is: If you select 4 and continue to the File Open dialog, then import Trace 4 from the file selected or entered in File Name option in the File Open dialog.

Key Path	Recall, Data, Trace
Mode	SA VSA

Instrument S/W Revision Prior to A.02.00

Display in Selected Trace

In Vector Signal Analyzer Mode, data registers are used as temporary storage places for trace data.

A register may be displayed in any trace. If "Display in Selected Trace" key is set to "Yes" then the data register into which the file is recalled is then assigned to the currently selected trace.

Example	!Related command: MMEM:LOAD:TRAC:DATA D1,"TRC1.TXT",TXT !This command explicitly puts the data in the specified trace.
Key Path	Recall, Data (Import), Trace (to)
Mode	VSA
Instrument S/W Revision	Prior to A.02.00

Amplitude Correction

Pressing this key selects the Amplitude Corrections as the data type to be imported with this recall request. This key brings up the Amplitude Correction Menu that allows you to select which Amplitude Correction to recall.

A set of preloaded Corrections files can be found in the directory

/My Documents/ EMC Limits and Ampcor.

Under this directory, the directory called Ampcor (Legacy Naming) contains a set of legacy corrections files, generally the same files that were supplied with older Agilent EMI analyzers, that use the legacy suffixes .ant, .oth, .usr, and .cbl, and the old 8-character file names. In the directory called Ampcor, the same files can be found, with the same suffixes, but with longer, more descriptive filenames.

Example	MMEM:LOAD:CORR 2,"MyCorrectionsData.csv" This loads the file of corrections data (on the default file directory path) into the specified correction table of date (2).
Dependencies/Couplings	Correction data is not available from all Measurements. In that case, the key will be grayed out. The key will not show if no measurements in the Mode support it. When a correction is loaded from mass storage, it is automatically turned on. This also turns on the global "Apply Corrections" function. Only the first correction array (Correction 1) supports antenna units. Note that this means that a correction file with an Antenna Unit can only be loaded into the Corrections 1 register. Consequently only for Correction 1 does the dropdown in the Recall dialog include .ant, and if an attempt is made to load a correction file into any other Correction register which DOES contain an antenna unit, a Mass Storage error is generated.
Key Path	Recall, Data

Recall

Mode	SA EDGE GSM
Preset	1 It is not part of Preset, but is reset by Restore Input/Output Defaults and survives subsequent running of the mode.
State Saved	Saved in instrument state.
Readback	1 2 3 4
Instrument S/W Revision	A.02.00

Amplitude Correction 1, 2, 3, 4

These menu key selections let you pick which Amplitude Correction to recall; either 1, 2, 3, or 4. The default is 1. Once selected, the key returns back to the Import Data menu and the selected Amplitude Correction number is annotated on the key. Now exactly what needs to be recalled has been selected. To trigger a recall of the selected Amplitude Correction, you must select the File Open key in the Import Data menu.

An example of using this menu is: if you select 4 and then continues on to the File Open menu, the amplitude correction table 4 will be recalled from the file selected or entered in File Name option in the File Open dialog. See [“File Open Dialog and Menu” on page 586](#) for more details.

Antenna corrections are a particular kind of Amplitude Corrections – they are distinguished by having the Antenna Unit set to a value other than None. See the Input/Output chapter discussion of Amplitude Corrections for details on Antenna Units.

Key Path	Recall, Data, Amplitude Correction
Mode	SA EDGE GSM
Readback	1
Instrument S/W Revision	A.02.00

Key Path	Recall, Data, Amplitude Correction
Mode	SA EDGE GSM
Readback	2
Instrument S/W Revision	A.02.00

Key Path	Recall, Data, Amplitude Correction
Mode	SA EDGE GSM
Readback	3
Instrument S/W Revision	A.02.00

Key Path	Recall, Data, Amplitude Correction
----------	---

Mode	SA EDGE GSM
Readback	4
Instrument S/W Revision	A.02.00

Limit Line

This key selects the Limit Lines as the data type to be imported with this recall request. It brings up the Limit Line Menu that lets you select which Limit Line to import the data into. This key is grayed out when SA measurements are running that do not support limit line importing.

A set of preloaded Corrections files can be found in the directory

/My Documents/ EMC Limits and Ampcor.

Under this directory, the directory called Limits (Legacy Naming) contains a set of legacy limits, generally the same files that were supplied with older Agilent EMI analyzers, that use the legacy suffix .lim, and the old 8-character file names. In the directory called Limits, the same files can be found, with the same suffix, but with longer, more descriptive filenames.

Example	MMEM:LOAD:LIM LLINE1,"MyLimitsFile.csv" This loads the limit line file data (on the default file directory path) into the specified limit line.
Dependencies/Couplings	Some Measurements do not allow the use of limit lines, so the key will be grayed out. The key will not show if no measurements in the Mode support it. When a limit line is loaded from mass storage, it is automatically turned on. This allows you to see it, thus confirming the load.
Key Path	Recall, Data
Mode	SA
Preset	1; not part of Preset, but is reset by Restore Mode Defaults and survives power cycles
State Saved	Saved in State
Readback	selected Limit Line
Readback	1 2 3 4 5 6
Instrument S/W Revision	A.02.00

Recall

Limit Line 1, 2, 3, 4, 5, 6

These keys let you pick which Limit Line to import the data into; either 1 or 2. The default is 1. Once selected, the key returns back to the Import Data menu and the selected Limit Line number is annotated on the key. Now you have selected exactly what needs to be imported. In order to trigger an import of the selected Limit Line, you must select the Open key in the Import Data menu.

An example of using this menu is: If you select 2 and continue to the File Open menu, the Limit Line 2 will be imported from the file selected or entered in File Name option in the File Open dialog.

Key Path	Recall, Data, Limit Line
Mode	SA
Instrument S/W Revision	A.02.00

Capture Buffer

Capture Buffer functionality is not available for all measurements. The captured data is raw data (unprocessed).

Example	MMEM:LOAD:CAPT "MyCaptureData.bin" This loads the file of capture data (on the default file directory path) into the instrument.
Dependencies/Couplings	Capture buffer data is not available from all Measurements. In that case, the key will be grayed out. The key will not show if no measurements in the Mode support it.
Key Path	Recall, Data
Mode	WCDMA
Instrument S/W Revision	Prior to A.02.00

Zone map

A map file contains zone definitions that will help simplify making measurements of frequently used signals. The OFDMA frame structure can contain multiple-zone definitions for the uplink and downlink subframes and multiple data burst allocations. You can recall map files in which you have saved complicated OFDMA frame analysis zone definitions; this can save you time and ensure the accuracy of repeat measurements. map files are also useful for recreating measurement settings so they can be used by other users.

Example	MMEM:LOAD:ZMAP "MyZonemapFile.omf" This loads the file of zone map data (on the default file directory path) into the custom map.
Dependencies/Couplings	Zone map data is not available from all Measurements. In that case, the key will be grayed out. The key will not show if no measurements in the Mode support it.
Key Path	Recall, Data

Mode	OFDMA WIMAX
Instrument S/W Revision	Prior to A.02.00

Recorded Data

This allows you to recall previously saved, recorded data for analysis.

This feature is only available with 89601X VSA Option 200 and Option G01.

Example	MMEM:LOAD:REC "MyRecording.sdf"
Key Path	Recall, Data (Import)
Mode	VSA
Notes	Available file types are: <ul style="list-style-type: none"> • CSV (Comma delimited) (*.csv) • MAT-File (*.mat) • MAT-File (Version 4) (*.mat) • MAT-File (HDF5) (*.mat;*.hdf;*.h5) • N5110A Waveform (*.bin) • SDF (Fast) (*.sdf;*.dat) • SDF (Export) (*.sdf;*.dat) • Text (Tab delimited) (*.txt)
Instrument S/W Revision	Prior to A.02.00

Open...

Pressing **File Open** brings up the File Open standard Windows dialog and the File Open key menu. When you navigate to this selection, they have already determined they are recalling a specific Data Type and now they want to specify which file to open.

When you first enter this dialog, the path is in the Look In: field in this File Open dialog depends on which import data type you navigated here from.

The only files that are visible are those specific to the file type being recalled.

Restriction and Notes	Brings up Open dialog for recalling a <mode specific> Save Type
Key Path	Recall, Data
Instrument S/W Revision	Prior to A.02.00

Recall

Open The import starts by checking for errors. Then the import can start. For all data types, the actual import starts by aborting the currently running measurement. Then the import does data type specific behavior:

Trace Import: A trace cannot be imported if the trace points in the file do not match the sweep points in the mode. If this happens, an error is generated. When a trace is imported, then **Trace Update** is always turned OFF for that trace and **Trace Display** is always turned ON. The trace file has meta data. If the meta data in the file does not match the corresponding SA state, the dirty marker is displayed.

Limit Line Import: The instrument cannot mix Limits domains (X Axis Unit must be Frequency or Time for both Limits). So when a Limits file is loaded, the analyzer will go to the Limits domain (X Axis Unit) of that file. If this changes the Limits domain from what it was before the file was loaded, all Limits data in both Limits sets will be erased before the data loads. There will be no warning if this occurs, so care should be taken to know the domain of the file you are loading.

When a Limit is loaded it will be turned ON. The Margin settings will match those when the limit was saved.

Amplitude Correction Import: When an amplitude correction data file is imported, the selected amplitude correction table is loaded with the data in the imported file. Also, the x axis interpolation value for that corrections table is recalled from the file and the correction table is interpolated across the entire span. Then the selected amplitude correction table is turned on (**Amplitude Correction ON** and **Amplitude Corrections Apply** set to Yes).

When the Amplitude Correction is an Antenna correction and the Antenna Unit in the file is not None, the Y Axis Unit setting will change to match that of the file.

Remote Command	<code>:MMEMory:LOAD:TRACe:DATA TRACE1 TRACE2 TRACE3 TRACE4 TRACE5 TRACE6, <filename></code>
Example	<code>:MMEM:LOAD:TRAC DATA TRACE2,"myTrace2.csv"</code> imports the 2nd trace from the file myTrace2.csv in the default path.
Remote Command Notes	Traces cannot be recalled from a trace data file that was saved with ALL traces selected. Errors are reported if the file is empty or missing, or if the file type does not match.
Mode	SA
Instrument S/W Revision	Prior to A.02.00
Remote Command	<code>:MMEMory:LOAD:TRACe:DATA D1 D2 D3 D4 D5 D6, <filename> [, CSV TXT SDF]</code>
Example	<code>:MMEM:LOAD:TRAC:DATA D1,"TRC1.TXT",TXT</code>
Restriction and Notes	If you are not licensed to recall a particular file type, then an error -203.9010 will be returned. If the file format cannot be determined or the file cannot be recalled successfully, then an error -250.5290 is returned. If the recall is successful, then advisory 0.1600 is shown.

Remote Command Notes	If the file format parameter is not included in the SCPI command, the file format is determined by the file name extension. If this is not sufficient, the file is scanned to determine the format.
Key Path	Recall, Data (Import), Trace (to), Open . . .
Mode	VSA
Instrument S/W Revision	Prior to A.02.00

Remote Command	:MMEMory:LOAD:CORRection 1 2 3 4, <filename>
Example	:MMEM:LOAD:CORR 2 "myAmpcor.csv" recalls the Amplitude Correction data from the file myAmpcor.csv on the default directory to the 2nd Amplitude Correction table, and turns on table 2.
Dependencies/Couplings	Amplitude Correction <number> is ON, Amplitude Corrections Apply is set to Yes, Amplitude Correction <number> interpolation is recalled from the file and the interpolation occurs for that table.
Remote Command Notes	Errors are generated if the specified file is empty or missing, or if there is a file type mismatch.
Mode	SA EDGE GSM
Instrument S/W Revision	Prior to A.02.00

Remote Command	:MMEMory:LOAD:LIMit LLINE1 LLINE2,<filename>
Example	:MMEM:LOAD:LIM LLINE2,"myLimitLine2.csv" imports the 2nd Limit Line from the file myLimitLine2.csv in the default path.
Remote Command Notes	Errors are reported if the file is empty or missing, or if the file type does not match.
SCPI Status Bits/OPC Dependencies	Sequential - aborts the current measurement
Key Path	Recall, Data, File Open
Mode	SA
Readback	floppy icon in the settings bar
Instrument S/W Revision	Prior to A.02.00

Recall captured data for reuse in demod measurements using the Load Capture Buffer functionality. This function is enabled for ‘Code Domain’ and ‘Modulation Accuracy’ measurements only.

Remote Command	:MMEMory:LOAD:CAPTured <filename>
Restriction and Notes	Errors are reported if the file is empty or missing, or if the file type does not match.

Recall

Example :MMEM:LOAD:CAPT "My Documents\WCDMA\data\IQ\captureBuffer\myCaptureBuffer.bin"

Key Path **Recall, Data, File Open**

Mode WCDMA

Instrument S/W Revision Prior to A.02.00

Remote Command :MMEMory:LOAD:RECORDing <filename>

Example :MMEM:LOAD:REC "MyRecording.sdf"

Remote Command Notes SCPI reflects the action performed when this key is selected and File Open is pressed.

Key Path **Recall, Data (Import), Recorded Data, Open . . .**

Mode VSA

Instrument S/W Revision Prior to A.02.00

Remote Command :MMEMory:LOAD:ZMAP <filename>

Example :MMEM:LOAD:ZMAP "myZoneMap.omf" recalls the Zone map data from the file myZoneMap.omf on the default directory to the Custom map for Modulation Analysis measurement.

Key Path **Recall, Data, Zone map**

Mode WIMAXOFDMA

Instrument S/W Revision Prior to A.02.00

File Open Dialog and Menu

The **File Open** is a standard Windows dialog and has a **File Open** key menu. Each key in this menu corresponds to the selectable items in the **File Open** dialog box. The menu keys can be used for easy navigation between the selections within the dialog or the standard **Tab** and **Arrow** keys can be used for dialog navigation. When you navigate to this selection, you have already limited the file recall type and now you want to specify which file to open.

Instrument S/W Revision Prior to A.02.00

Open

This selection and the **Enter** key when a filename has been selected or specified actually cause the load to occur. **Open** loads the specified or selected file to the previously selected recall type of either **State** or a specific import data type.

Restriction and Notes: Advisory Event "File <file name> recalled" after recall is complete.

Instrument S/W Revision: Prior to A.02.00

File/Folder List

This menu key navigates to the center of the dialog that contains the list of files and folders. Once here you can get information about the file.

Restriction and Notes	Pressing this key navigates you to the files and folders list in the center of the dialog.
Key Path	Recall, <various>, Open...
Instrument S/W Revision	Prior to A.02.00

Sort

Pressing this key brings up the Sort menu that allows you a way to sort the files within the File Open scope. Only one sorting type can be selected at a time and the sorting happens immediately.

Remote Command Notes	No SCPI command directly controls the sorting.
Key Path	Recall, <various>, Open...
Instrument S/W Revision	Prior to A.02.00

By Date This allows you to sort the list of files within the scope of the File Open dialog in ascending or descending data order. The date is the last data modified.

Restriction and Notes	Files in File Open dialog are sorted immediately in the selected order
Key Path	Recall, <various>, Open..., Sort
Instrument S/W Revision	Prior to A.02.00

By Name

This allows you to sort the list of files within the scope of the File Open dialog in ascending or descending order based on the filename.

Restriction and Notes	Files in File Open dialog are sorted immediately in the selected order.
Key Path	Recall, <various>, Open..., Sort
Instrument S/W Revision	Prior to A.02.00

By Extension

This allows you to sort the list of files within the scope of the File Open dialog in ascending or descending order based on the file extension for each file.

Restriction and Notes	Files in File Open dialog are sorted immediately in the selected order.
Key Path	Recall, <various>, Open..., Sort
Instrument S/W Revision	Prior to A.02.00

Recall

By Size

This allows you to sort the list of files within the scope of the File Open dialog in ascending or descending order based on file size.

Restriction and Notes	Files in File Open dialog are sorted immediately in the selected order.
Key Path	Recall, <various>, Open..., Sort
Instrument S/W Revision	Prior to A.02.00

Ascending

This causes the display of the file list to be sorted, according to the sort criteria above, in Ascending order.

Restriction and Notes	Files in File Open dialog are sorted immediately in the selected order.
Key Path	Recall, <various>, Open..., Sort
Instrument S/W Revision	Prior to A.02.00

Descending

This causes the display of the file list to be sorted, according to the sort criteria above, in Descending order.

Restriction and Notes	Files in File Open dialog are sorted immediately in the selected order.
Key Path	Recall, <various>, Open..., Sort
Instrument S/W Revision	Prior to A.02.00

Files Of Type

This menu key corresponds to the Files Of Type selection in the dialog. It follows the standard Windows supported Files Of Type behavior. It shows the current file suffix that corresponds to the type of file you have selected to save. If you navigated here from recalling State, "State File (*.state)" is in the dialog selection and is the only type available in the pull down menu. If you navigated here from recalling Trace, "Trace+State File (*.trace)" is in the dialog selection and is the only type available under the pull down menu.

If you navigated here from importing a data file, the data types available will be dependent on the current measurement and the selection you made under "Import Data". For example:

Amplitude Corrections: pull down menu shows

- Amplitude Corrections (*.csv)
- Legacy Cable Corrections (*.cbl)
- Legacy User Corrections (*.amp)
- Legacy Other Corrections (*.oth)
- Legacy Antenna Corrections (*.ant)

Limit: pull down menu shows

Limit Data (*.csv)

Legacy Limit Data (*.lim)

Trace: pull down menu shows "Trace Data (*.csv)"

Restriction and Notes	Pressing this key causes the pull down menu to list all possible file types available in this context.
Key Path	Recall, <various>, Open...
Instrument S/W Revision	Prior to A.02.00

Up One Level

This menu key corresponds to the icon of a folder with the up arrow that is in the tool bar of the dialog. It follows the standard Windows supported Up One Level behavior. When pressed, it causes the file and folder list to navigate up one level in the directory structure.

Restriction and Notes	When pressed, the file and folder list is directed up one level of folders and the new list of files and folders is displayed.
Key Path	Recall, <various>, Open...
Instrument S/W Revision	Prior to A.02.00

Cancel

This menu key corresponds to the Cancel selection in the dialog. It causes the current File Open request to be cancelled. It follows the standard Windows supported Cancel behavior.

Restriction and Notes	Pressing this key causes the Open dialog to go away and auto return.
Key Path	Recall, <various>, Open...
Instrument S/W Revision	Prior to A.02.00

Recall

Restart

The Restart function restarts the current sweep, or measurement, or set of averaged/hold sweeps or measurements. If you are Paused, pressing Restart does a Resume.

The Restart function is accessed in several ways:

- Pressing the Restart key
- Sending the remote command INIT:IMMEDIATE
- Sending the remote command INIT:RESTART

Remote Command:	:INITiate[:IMMEDIATE]
Example:	:INIT:IMM
Dependencies/Couplings:	Resets average/hold count k. For the first sweep overwrites all active (update=on) traces with new current data. For application modes, it resets other parameters as required by the measurement.
Remote Command Notes:	:INITiate:RESTART :INITiate:IMMEDIATE Either of the above commands perform exactly the same function.
SCPI Status Bits/OPC Dependencies:	This is an Overlapped command. The STATUS:OPERATION register bits 0 through 8 are cleared. The STATUS:QUESTIONABLE register bit 9 (INTEGRITY sum) is cleared. The SWEEPING bit is set. The MEASURING bit is set.
Instrument S/W Revision:	Prior to A.02.00

Remote Command:	:INITiate:RESTART
Example:	:INIT:REST
Dependencies/Couplings:	Resets average/hold count k. For the first sweep overwrites all active (update=on) traces with new current data. For application modes, it resets other parameters as required by the measurement.
Remote Command Notes:	:INITiate:RESTART :INITiate:IMMEDIATE Either of the above commands perform exactly the same function.

Restart

SCPI Status Bits/OPC Dependencies:	This is an Overlapped command. The STATUS:OPERation register bits 0 through 8 are cleared. The STATUS:QUESTionable register bit 9 (INTegrity sum) is cleared. The SWEEPING bit is set. The MEASURING bit is set.
Instrument S/W Revision:	Prior to A.02.00

The **Restart** function first aborts the current sweep/measurement as quickly as possible. It then resets the sweep and trigger systems, sets up the measurement and initiates a new data measurement sequence with a new data acquisition (sweep) taken once the trigger condition is met.

If the analyzer is in the process of aligning when **Restart** is executed, the alignment finishes before the restart function is performed.

Even when set for Single operation, multiple sweeps may be taken when Restart is pressed (for example, when averaging/holding is on). Thus when we say that **Restart** "restarts a measurement," we may mean:

- It restarts the current sweep
- It restarts the current measurement
- It restarts the current set of sweeps if any trace is in Trace Average, Max Hold or Min Hold
- It restarts the current set of measurements if Averaging, or Max Hold, or Min Hold is on for the measurement
- depending on the current settings.

With **Average/Hold Number** (in **Meas Setup** menu) set to 1, or Averaging off, or no trace in Trace Average or Hold, a single sweep is equivalent to a single measurement. A single sweep is taken after the trigger condition is met; and the analyzer stops sweeping once that sweep has completed. However, with **Average/Hold Number** >1 and at least one trace set to **Trace Average**, **Max Hold**, or **Min Hold (SA Measurement)** or **Averaging on (most other measurements)**, multiple sweeps/data acquisitions are taken for a single measurement. The trigger condition must be met prior to each sweep. The sweep is stopped when the average count k equals the number N set for **Average/Hold Number**. A measurement average usually applies to all traces, marker results, and numeric results; but sometimes it only applies to the numeric results.

Once the full set of sweeps has been taken, the analyzer will go to idle state. To take one more sweep without resetting the average count, increment the average count by 1, by pressing the step up key while **Average/Hold Number** is the active function, or sending the remote command CALC:AVER:TCON UP.

Save

Save functionality is common across multiple Modes and Measurements. These common features are described in this section.

The Save feature prompts you to essentially answer the questions: What do you want to save? And where do you want to save it? Once these questions are answered the save can occur. The options in this menu answer the question, "What do you want to save?"

Accesses a menu that provides the save type options. The **Save Type** options are **State**, **Trace**, **Data**, or a **Screen Image** depending on the active mode.

Remote Command Notes	No remote command for this key specifically.
Key Path	Save
Mode	All
Instrument S/W Revision	Prior to A.02.00

State

Selects **State** as the save type and accesses a menu that provides the options of where to save. You can save either to a register or a file. This menu key will not actually cause the save until the location is chosen.

Saving the state is the only way to save this exact measurement context for the current active mode. The entire state of the active mode is saved in a way that when a recall is requested, the mode will return to as close as possible the context in which the save occurred. This includes all settings and data for only the current active mode.

It should be noted that the Input/Output settings will be saved when saving State, since these settings plus the state of the mode best characterize the current context of the mode, but the mode independent System settings will not be saved.

This key will not actually cause the save, since the save feature still needs to know where to save the state. Pressing this key will bring up the Save State menu that provides you with these options.

For rapid saving, the State menu lists registers to save to, or you can select a file to save to. Once they pick the destination of the save in the State menu, the save will occur.

Example	MMEM:STOR:STATe "MyStateFile.state" This stores the current instrument state data in the file MyStateFile.state in the default directory.
Remote Command Notes	See "Save" on page 599 .
Key Path	Save
Mode	All
Instrument S/W Revision	Prior to A.02.00

Save

Register 1 thru Register 6

Selecting any one of these register menu keys causes the State of the currently active mode to be saved to the specified Register. The registers are provided for rapid saving and recalling, since you do not need to specify a filename or navigate to a file. Each of the register menu keys annotates whether it is empty or at what date and time it was last modified.

These 6 registers are all that is available from the front panel for all modes in the instrument. There are not 6 registers available for each mode. From remote, 127 Registers are available. Registers are files that are visible to you in the My Documents\System folder.

Example	*SAV 1
Key Path	Save, State
Mode	All
Readback	Date and time with seconds resolution are displayed on the key, or "(empty)" if no prior save operation performed to this register.
Instrument S/W Revision	Prior to A.02.00
Example	*SAV 2
Key Path	Save, State
Mode	All
Readback	Date and time with seconds resolution are displayed on the key, or "(empty)" if no prior save operation performed to this register.
Instrument S/W Revision	Prior to A.02.00
Example	*SAV 3
Key Path	Save, State
Mode	All
Readback	Date and time with seconds resolution are displayed on the key, or "(empty)" if no prior save operation performed to this register.
Instrument S/W Revision	Prior to A.02.00
Example	*SAV 4
Key Path	Save, State
Mode	All
Readback	Date and time with seconds resolution are displayed on the key, or "(empty)" if no prior save operation performed to this register.
Instrument S/W Revision	Prior to A.02.00

Example	*SAV 5
Key Path	Save, State
Mode	All
Readback	Date and time with seconds resolution are displayed on the key, or "(empty)" if no prior save operation performed to this register.
Instrument S/W Revision	Prior to A.02.00

Example	*SAV 6
Key Path	Save, State
Mode	All
Readback	Date and time with seconds resolution are displayed on the key, or "(empty)" if no prior save operation performed to this register.
Instrument S/W Revision	Prior to A.02.00

To File . . .

Accesses a menu that enables you to select the location for saving the State. This menu is similar to a standard Windows® **Save As** dialog.

The default path for all State Files is:

My Documents\<<mode name>\state

where <mode name> is the parameter used to select the mode with the INST:SEL command (for example, SA for the Spectrum Analyzer). This path is the **Save In:** path in the **Save As** dialog for all State Files when they first enter this dialog.

Key Path	Save, State
Mode	All
Instrument S/W Revision	Prior to A.02.00

Save As . . .

This menu lets you select the location where you can save the State. This menu is a standard Windows® dialog with Save As menu keys. The "File Name" field in the Save As dialog is initially loaded with an automatically generated filename specific to the appropriate Save Type. The automatically generated filename is guaranteed not to conflict with any filename currently in the directory. You may replace or modify this filename using the File Name key. See the Quick Save key documentation for more on the automatic file naming algorithm.

The default path for all State Files is:

My Documents\<<mode name>\state

where <mode name> is the parameter used to select the mode with the INST:SEL command (for example, SA for the Spectrum Analyzer).

Save

When you first enter this dialog, the path in the **Save In:** field depends on the data type. The only files that are visible are the *.state files and the Save As type is *.state, since .state is the file suffix for the State Save Type.

Key Path	Save, State
Mode	All
Instrument S/W Revision	Prior to A.02.00

Save

Saves all of the State of the currently active mode plus the system level Input/Output settings to the specified file.

While the save is being performed, the floppy icon shows up in the settings bar near the Continuous/Single sweep icon. After the save completes, the Advisory Event "File <register number> saved" is displayed.

Remote Command	:MMEMory:STORe:STATe <filename>
Example	:MMEM:STOR:STAT "myState.state" saves the file myState.state on the default path
Restriction and Notes	If the file already exists, the file will be overwritten. Using the C: drive is strongly discouraged, since it runs the risk of being overwritten during a instrument software upgrade. Both single and double quotes are supported for any filename parameter over remote. Auto return to the State menu and the Save As dialog goes away.
Key Path	Save, State, To File...
Mode	All
Instrument S/W Revision	Prior to A.02.00

Trace (+State)

Selects a state file which includes trace data for recalling as the save type and accesses a menu that enables you to select which trace to save. You can save to either a register or a file. Not all modes support saving trace data with the state; and for modes that do, not all measurements do. This key is grayed out for measurements that do not support trace saves. It is blanked for modes that do not support trace saves. Saving **Trace** is identical to saving State except a .trace extension is used on the file instead of .state, and internal flags are set in the file indicating which trace was saved. You may also select to save ALL traces.

This key will not actually cause the save, since the save feature still needs to know which trace to save and where to save it. Pressing this key will bring up the Save Trace menu that provides you with these options.

For rapid saving, the Trace menu lists registers to save to, or you can select a file to save to. Once you pick the destination of the save in the Trace menu, the save will occur.

Example	MMEM:STOR:STATe TRACE2,"MyTraceFile.trace" This stores trace 2 data in the file MyTraceFile.trace in the default directory. :MMEM:STOR:TRAC:REG TRACE1,2 stores trace 1 data in trace register 2 :MMEM:STOR:TRAC:REG ALL,3 saves the data for all 6 traces in trace register 3
Remote Command Notes	See “Save” on page 599 .
Key Path	Save
Mode	SA
Instrument S/W Revision	Prior to A.02.00

Register 1 thru Register 5

Selecting any one of these register menu keys causes the Trace(s) specified under From Trace, along with the state of the currently active mode, to be saved to the specified Trace Register. The registers are provided for rapid saving and recalling, since you do not need to specify a filename or navigate to a file. Each of the register menu keys annotates whether it is empty or at what date and time it was last modified.

These 5 trace registers are all that is available for all modes in the instrument. At present, only the Swept SA measurement of the Spectrum Analyzer mode supports saving to Trace+State files. Registers are files that are visible to you in the My Documents\System folder.

Key Path	Save, Trace
Mode	SA
Readback	Date and time with seconds resolution are displayed on the key, or "(empty)" if no prior save operation performed to this register.
Instrument S/W Revision	Prior to A.02.00
Key Path	Save, Trace
Mode	SA
Readback	Date and time with seconds resolution are displayed on the key, or "(empty)" if no prior save operation performed to this register.
Instrument S/W Revision	Prior to A.02.00
Key Path	Save, Trace
Mode	SA

Save

Readback	Date and time with seconds resolution are displayed on the key, or "(empty)" if no prior save operation performed to this register.
Instrument S/W Revision	Prior to A.02.00
Key Path	Save, Trace
Mode	SA
Readback	Date and time with seconds resolution are displayed on the key, or "(empty)" if no prior save operation performed to this register.
Instrument S/W Revision	Prior to A.02.00
Key Path	Save, Trace
Mode	SA
Readback	Date and time with seconds resolution are displayed on the key, or "(empty)" if no prior save operation performed to this register.
Instrument S/W Revision	Prior to A.02.00

From Trace

Accesses a menu that enables you to select the trace to be saved. You can choose either 1, 2, 3, 4, 5, 6 or All. Not all modes have the full six traces. Once a trace is selected, the key returns back to the Save Trace menu and the selected trace number is annotated on the key. The default is the currently selected trace, selected in this menu or in the Trace/Det, Export Data, Import Data or Recall Trace menus, except if you have chosen All then it remains chosen until you specifically change it to a single trace. To save the Trace you must select **Save As**.

These keys let you pick which trace to save. Now you have selected exactly what needs to be saved. In order to trigger a save of the selected **Trace**, you must select the **Save As** key in the Save Trace menu.

Key Path	Save, Trace + State
Mode	SA
Instrument S/W Revision	Prior to A.02.00

Save As . . .

This menu lets you select the location where you can save the Trace. It is a standard Windows® dialog with Save As menu keys.

The "File Name" field in the Save As dialog is initially loaded with an automatically generated filename specific to the appropriate Save Type. The automatically generated filename is guaranteed not to conflict with any filename currently in the directory. You may replace or modify this filename using the File Name key. See the Quick Save key documentation for more on the automatic file naming algorithm.

The default path for all State Files including .trace files is:

My Documents\<<mode name>\state

where <mode name> is the parameter used to select the mode with the INST:SEL command (for example, SA for the Spectrum Analyzer).

When you first enter this dialog, the path in the Save In: field depends on the data type. The only files that are visible are the *.trace files and the Save As type is *.trace, since .trace is the file suffix for the Trace Save Type.

Restriction and Notes	Brings up Save As dialog for saving a Trace Save Type
Key Path	Save, Trace (+State)
Mode	SA
Instrument S/W Revision	Prior to A.02.00

Save

This key initiates the save of the .trace file. All of the State of the currently active mode plus the system level Input/Output settings are saved to the specified file as well as all of the trace data, including internal flags set in the file indicating which trace is to be saved.

While the save is being performed, the floppy icon shows up in the settings bar near the Continuous/Single sweep icon. After the save completes, the Advisory Event "File <register number> saved" is displayed.

Remote Command	<pre>:MMEMory:STORe:TRACe TRACE1 TRACE2 TRACE3 TRACE4 TRACE5 TRACE6 ALL, <filename> > :MMEMory:STORe:TRACe:REGister TRACE1 TRACE2 TRACE3 TRACE4 TRACE5 TRACE6 ALL, <integer></pre>
Example	<pre>:MMEM:STOR:TRAC TRACE1,"myState.trace" saves the file myState.trace on the default path and flags it as a "single trace" file with Trace 1 as the single trace (even though all of the traces are in fact stored). :MMEM:STOR:TRAC ALL,"myState.trace" saves the file myState.trace on the default path and flags it as an "all traces" file :MMEM:STOR:TRAC:REG TRACE1,2 stores trace 1 data in trace register 2</pre>
Remote Command Notes	<p>Some modes and measurements do not have available all 6 traces. The Phase Noise mode command, for example, is: MMEMory:STORe:TRACe TRACE1 TRACE2 TRACE3 ALL,<filename></p> <p>This command actually performs a save state, which in the Swept SA measurement includes the trace data. However it flags it (in the file) as a "save trace" file of the specified trace (or all traces).</p> <p>The range for the register parameter is 1–5</p>

Save

Restriction and Notes	<p>If the file already exists, the file will be overwritten. Using the C: drive is strongly discouraged, since it runs the risk of being overwritten during a instrument software upgrade. Both single and double quotes are supported for any filename parameter over remote.</p> <p>Auto return to the State menu and the Save As dialog goes away.</p>
Key Path	Save, Trace, Save As...
Mode	SA
Instrument S/W Revision	Prior to A.02.00

Data (Mode Specific)

Exporting a data file stores data from the current measurement to mass storage files. The Export Menu only contains data types that are supported by the current measurement.

For any given mode, the Export Data and Import Data menus match, but keys in Import Data are blanked if the data type is supported for Save but not for Recall.

Since the commonly exported data files are in .csv format, the data can be edited by you prior to importing. This allows you to export a data file, manipulate the data in Excel (the most common PC Application for manipulating .csv files) and then import it.

Selecting an Export Data menu key will not actually cause the exporting to occur, since the analyzer still needs to know where you wish to save the data. Pressing the Save As key in this menu brings up the Save As dialog and Save As menu that allows you to specify the destination file and directory. Once a filename has been selected or entered in the Open menu, the export will occur as soon as the Save key is pressed. See section [“Save As . . .” on page 614](#) for more details.

Remote Command Notes	No SCPI command directly controls the Data Type that this key controls. The Data Type is included in the MMEM:STORE commands.
Dependencies/Couplings	If a file type is not used by a certain measurement, that type is grayed out for that measurement. The key for a file type will not show if there are no measurements in Mode that supports it.
Key Path	Save
Mode	All
Preset	<mode specific>; Is not affected by Preset, but is reset during Restore Mode Defaults and survives subsequent running of the mode.
Readback	1-of-N selection
Instrument S/W Revision	Prior to A.02.00

Trace

Pressing this key selects Traces as the data type to be exported with this save request. Pressing this key when it is already selected brings up the Trace Menu, which allows you to select which Trace to save. This is the same as the Select Trace menu under Trace. The trace selected on that menu appears selected here, and selecting a trace here causes the same trace to be selected on the Select Trace menu. (That is, there is only one "selected trace".) This key is grayed out when measurements are running that do not support trace exporting.

Example	MMEM:STOR:TRAC:DATA TRACE3,"MyTraceFile.csv" This stores the specified trace data in the file MyTraceFile.csv in the default directory. VSA Example: MMEM:STOR:TRAC:DATA TRACE1,"Trc1.txt",TXT,ON
Remote Command Notes	See "Save" on page 606
Dependencies/Couplings	Trace data is not available from all Measurements. In that case, the key will be grayed out. The key will not show if no measurements in the Mode support it. For SA measurements, traces cannot be recalled from a trace file that was saved with ALL traces selected.
Key Path	Save, Data
Mode	SA Analog Demod VSA
Preset	Not part of Preset, but is reset by Restore Mode Defaults and survives power cycles.
State Saved	Saved in State
Readback	selected Trace table
Readback	Swept SA: 1 2 3 4 5 6 ALL Analog Demod Mode: RF Spectrum Demod Demod Ave Demod Max Demod Min AF Spectrum Vector Signal Analyzer: Trace 1 Trace 2 with header Trace 2 Trace 2 with header Trace 3 Trace 3 with header Trace 4 Trace 4 with header Trace 5 Trace 5 with header Trace 6 Trace 6 with header
Instrument S/W Revision	Prior to A.02.00

Trace selection

These keys let you pick which Trace to save. The traces may have names, or they may be labeled 1, 2, 3, 4, 5, or 6, depending on the current mode. Once selected, the key returns back to the Export Data menu and the selected trace name/number is annotated on the key. The default is the currently selected trace, selected in this menu or in the Trace/Det, Import Data, Recall Trace or Save Trace menus, except if you have chosen All then it remains chosen until you specifically change it to a single trace.

To trigger a save of the selected trace, you must select the Save As key in the Export Data menu.

Save

Some measurements have an "ALL" selection. This saves all six traces in one .csv file with the x-axis data in the first column and the individual trace data in succeeding columns. The header data and x-axis data in this file reflect the current settings of the measurement. Note that any traces which are in View or Blank may have different x-axis data than the current measurement settings; but this data will not be output to the file.

Key Path	Save, Data, Trace
Mode	SA Analog Demod VSA
Preset	The first trace key shown.
Instrument S/W Revision	Prior to A.02.00

Include Header

The trace header information includes enough state information to display the trace data with the same formatting and scaling when it is recalled. However, no other instrument state information is saved. If headers are not saved, the scaling and format are set to defaults when the trace is recalled.

Example	MMEM:STOR:TRAC:DATA TRACE1,"Trc1.txt",TXT,ON The On/Off setting is the last variable passed in the MMEMory:STORe:TRACe:DATA command.
---------	---

Key Path	Save, Data, Trace
Mode	VSA
Preset	On
Instrument S/W Revision	Prior to A.02.00

Measurement Results

Different types of results are available for each particular measurement. The results that are available are documented under the individual measurements. These measurement results are the same as the results that are returned when using the MEASure:<measurement> command (usually for sub-opcode 1).

Measurement results may not be available for all measurements.

Example	MMEM:STOR:RES "MyResultsFile.xml" This stores the measurement results data in the file MyResultsFile.xml in the default directory.
Remote Command Notes	See "Save" on page 606
Dependencies/Couplings	The key will not show if no measurements in the Mode support it.
Key Path	Save, Data
Mode	SA ADEMOD BASIC(IQ Analyzer) CDMA2K EDGE GSM PNOISE WCDMA WIMAX OFDMA TDS CDMA

Instrument S/W Revision Prior to A.02.00

Amplitude Correction

Pressing this key selects the **Amplitude Corrections** as the data type to be exported with this save request. This key brings up the Amplitude Correction Menu that allows you to select which **Amplitude Correction** to save.

Example:	MMEM:STOR:CORR 3,"MyCorrectionsFile.csv"
	This stores the specified corrections data (3) in the file MyCorrectionsFile.csv in the default directory.
Remote Command Notes:	See "Save" on page 606
Key Path:	Save, Data
Preset:	1; Is not part of Preset, but is reset by Restore Input/Output Defaults and survives subsequent running of the mode
State Saved:	Saved in instrument state.
Readback:	1 2 3 4
Dependencies/Couplings:	The key will not show if no measurements in the Mode support it.
Instrument S/W Revision:	A.02.00

Amplitude Correction 1, 2, 3, 4

These menu key selections let you pick which Amplitude Correction to save; either 1, 2, 3, or 4. The default is **1**. Once selected, the key returns back to the **Export Data** menu and the selected Amplitude Correction number is annotated on the key. Now exactly what needs to be saved has been selected. In order to trigger a save of the selected **Amplitude Correction**, you must select the **Save As** key in the **Export Data** menu.

An example of using this menu is: if you select 4, the Amplitude Correction table 4 will be saved to the file selected or entered in File Name option in the Save As dialog. See ["Save As . . ." on page 614](#) for more details.

Key Path	Save, Data, Amplitude Correction
Readback	1
Instrument S/W Revision	A.02.00
Key Path	Save, Data, Amplitude Correction
Readback	2
Instrument S/W Revision	A.02.00
Key Path	Save, Data, Amplitude Correction

Save

Readback 3
Instrument S/W Revision A.02.00

Key Path **Save, Data, Amplitude Correction**

Readback 4
Instrument S/W Revision A.02.00

Limit Line

Pressing this key selects the Limit Lines as the data type to be exported with this save request. This key brings up the Limit Line Menu that allows you to select which **Limit Line** to save. This key is grayed out when SA measurements are running that do not support limit line exporting.

Example: MMEM:STOR:LIM LLINE1,"MyLimitsFile.csv"
This stores the specified limit line data in the file MyLimitsFile.csv in the default directory.

Remote Command Notes: See ["Save" on page 606](#)

Dependencies/Couplings: Some Measurements do not allow the use of limit lines, so the key will be grayed out. The key will not show if no measurements in the Mode support it.

Preset: 1; not part of Preset, but is reset by Restore Mode Defaults and survives power cycles

State Saved: Saved in State

Key Path: **Save, Data**

Readback: selected Limit Line

Readback: 1|2|3|4|5|6

Instrument S/W Revision: A.02.00

Limit Line 1, 2, 3, 4, 5, 6

These keys let you pick which Limit Line to save. The default is **1**. Once selected, the key returns back to the **Export Data** menu and the selected Limit Line number is annotated on the key. Now you have selected exactly what needs to be saved. To trigger a save of the selected Limit Line, you must select the Save As key in the Export Data menu.

An example of using this menu is: If you select 2, the Limit Line 2 will be saved in the format described in Section Limit Line Data File to the file selected or entered in **File Name** option in the **Save As** dialog.

Key Path **Save, Data, Limit Line**
Instrument S/W Revision A.02.00

Capture Buffer

Capture Buffer functionality is not available for all measurements. The captured data is raw data (unprocessed).

Example	MMEM:STOR:CAPT "MyCaptureData.bin" This stores the capture data in the file MyCaptureData.bin in the default directory.
Remote Command Notes	See “Save” on page 606
Dependencies/Couplings	The key will not show if no measurements in the Mode support it.
Key Path	Save, Data
Mode	WCDMA
Instrument S/W Revision	Prior to A.02.00

Zone map

A map file contains zone definitions that will help simplify making measurements of frequently used signals. The OFDMA frame structure can contain multiple-zone definitions for the uplink and downlink subframes and multiple data burst allocations. You can store map files in which you have saved complicated OFDMA frame analysis zone definitions. This can save you time and ensure the accuracy of repeated measurements. map files are also useful for recreating measurement settings so they can be used by other users.

Example	MMEM:STOR:ZMAP "MyZonemapFile.omf" This stores the zone map data in the file MyZonemapFile.omf in the default directory.
Remote Command Notes	See “Save” on page 606
Dependencies/Couplings	The key will not show if no measurements in the Mode support it.
Key Path	Save, Data
Mode	OFDMA WiMAX
Instrument S/W Revision	Prior to A.02.00

Recorded Data

Saving recorded data is not available for all measurements. Recorded data, and the optional header info, may be recalled later (or transferred to another instrument) for analysis.

This function is available in 89601X VSA Option 200, but not in Option 205.

Example	MMEM:STOR:REC "MyRecording.sdf",SDF,ON,ON,OFF
Restriction and Notes	Grayed out unless there is recorded data in the buffer.

Save

Key Path	Save, Data (Export)
Mode	VSA
Instrument S/W Revision	Prior to A.02.00

Save As . . .

This menu lets you select the location where you can save Data Type files. It is a standard Windows® dialog with Save As menu keys. The "File Name" field in the Save As dialog is initially loaded with an automatically generated filename specific to the appropriate Save Type. The automatically generated filename is guaranteed not to conflict with any filename currently in the directory. You may replace or modify this filename using the File Name key. See the Quick Save key documentation for more on the automatic file naming algorithm.

When you first enter this dialog, the path in the Save In: field depends on the data type. The only files that are visible are the files with the corresponding data type suffix, and the **Save As** type lists the same suffix.

For example, if the Data Type is **Amplitude Corrections**, the file suffix is .csv and the *.csv files are the only visible files in the **Save As** dialog and .csv is the Save As Type.

The default path for saving files is:

For all of the Trace Data Files:

My Documents\`<mode name>`\data\traces

For all of the Limit Data Files:

My Documents\`<mode name>`\data\limits

For all of the Measurement Results Data Files:

My Documents\`<mode name>`\data\`<measurement name>`\results

For all of the Capture Buffer Data Files:

My Documents\`<mode name>`\data\captureBuffer

Restriction and Notes	Brings up Save As dialog for saving a <code><mode specific></code> Save Type
Key Path	Save, Data
Mode	All
Instrument S/W Revision	Prior to A.02.00

Save

Saves the specified Data Type. This section describes any specific save behavior relevant to Data that is common to all modes.

When a Save of a specific Data File is requested, the specified data is saved to the specified or selected file. The save is performed immediately and does not wait until the measurement is complete.

If the file already exists, a dialog will popup that allows you to replace the existing file by selecting an **OK** or you can **Cancel** the request.

While the save is being performed, the floppy icon will show up in the settings bar near the Continuous/Single icon. After a register save completes, the corresponding register key annotation is updated with the date the time and an advisory message that the file was saved appears in the message bar.

Restriction and Notes If the file already exists, the file will be overwritten. Using the C: drive is strongly discouraged, since it runs the risk of being overwritten during a instrument software upgrade. Both single and double quotes are supported for any filename parameter over remote.

Key Path **Save, Data, Save As...**

Instrument S/W Revision Prior to A.02.00

Remote Command `:MMEMory:STORe:RESults <filename>`

Example `:MMEM:STOR:RES "myResults.csv"` saves the results from the current measurement to the file myResults.csv in the default path.

`:MMEM:STOR:RES`

`"MyDocuments\Basic\data\ComplexSpectrum\results\myResults.xml"` saves the results from the current measurement (Complex Spectrum) to the file myResults.xml in the default path for IQ Analyzer (Basic) Mode.

This command form is not supported for the Swept SA measurement; see below.

Mode SA|ADEMOD|BASIC(IQ Analyzer)|CDMA2K|EDGE|GSM|PNOISE|WCDMA|WIMAX|OFDMA|TDSCDMA

Instrument S/W Revision Prior to A.02.00

Remote Command `:MMEMory:STORe:RESults:MTABle|PTABle <filename>`

Example `:MMEM:STOR:RES:MTAB "myResults.csv"` saves the results from the current marker table to the file myResults.csv in the default path.

`:MMEM:STOR:RES:PTAB "myResults.csv"` saves the results from the current peak table to the file myResults.csv in the default path.

This command form is only supported for the Swept SA measurement; see above.

Save

Dependencies/Couplings	<p>If a save of Marker Table results is requested and the Marker Table is not on, no file is saved an error is generated:</p> <p>Mass Storage error; Mkr Table must be on to save Mkr Table as Meas Results</p> <p>If a save of Peak Table results is requested and the Peak Table is not on, no file is saved an error is generated:</p> <p>Mass Storage error; Pk Table must be on to save Pk Table as Meas Results</p>
Mode	SA
Preset	Peak Table
State Saved	Saved in State
Range	Peak Table Marker Table
Instrument S/W Revision	Prior to A.02.00

Remote Command :MMEMory:STORe:CORRection 1|2|3|4, <filename>

Example :MMEM:STOR:CORR 2 "myAmpcor.csv" saves just the 2nd Amplitude Correction table to the file myAmpcor.csv on the default path.

Mode	SA
Instrument S/W Revision	A.02.00

Remote Command :MMEMory:STORe:TRACe:DATA TRACE1|TRACE2|TRACE3|TRACE4|TRACE5|TRACE6|ALL, <filename>

Example :MMEM:STOR:TRAC:DATA TRACE2,"myTrace2.csv" exports the 2nd trace to the file myTrace2.csv in the default path.

Remote Command Notes Not all measurements have the ALL selection. Traces cannot be recalled from files that were saved using the ALL selection.

If the save is initiated via SCPI, and the file already exists, the file will be overwritten.

Using the C: drive is strongly discouraged, since it runs the risk of being overwritten during an instrument software upgrade. Both single and double quotes are supported for any filename parameter over remote.

Mode	SA Analog Demod
Instrument S/W Revision	Prior to A.02.00

Trace Number **Analog Demod Mode:**

Trace Names

TRACE1 RF Spectrum

TRACE2 Demod

Trace Number **Analog Demod Mode: Trace Names**

TRACE3	Demod Ave
TRACE4	Demod Max
TRACE5	Demod Min
TRACE6	AF Spectrum

Remote Command	<code>:MMEMory:STORe:TRACe:DATA TRACE1 TRACE2 TRACE3 TRACE4 TRACE5 TRACE6 , "<filename>" [, CSV TXT SDF [, OFF ON 0 1]]</code>
Example	<code>MMEM:STOR:TRAC:DATA TRACE1,"Trc1.txt",TXT,ON</code>
Restriction and Notes	<p>If you are not licensed to save a particular file type, then an error will be returned. If an invalid file format is specified or the file cannot be saved successfully, then an error is returned.</p> <p>8901X Option 205 allows export in TXT, CSV, and SDF formats.</p> <p>8901X Option 200 allows the Option 205 formats and additionally: Matlab 4, 5 and HDF5, and an N5110A compatible binary format.</p>
Remote Command Notes	<p>File format is selected by the second parameter, but no default extension is appended to the filename. If the second parameter is not supplied, then the filename extension is used to determine the format. *.mat selects Matlab 5 format. *.sdf, or an unrecognized extension chooses the SDF fast format.</p> <p>The optional Boolean determines if the file is saved with headers. By default the headers are saved.</p>
Mode	VSA
Instrument S/W Revision	Prior to A.02.00
Remote Command	<code>:MMEMory:STORe:LIMit LLINE1 LLINE2 ,<filename></code>
Example	<code>:MMEM:STOR:LIM LLINE2,"myLimitLine2.csv" saves the 2nd Limit Line to the file myLimitLine2.csv in the default path.</code>
Remote Command Notes	<p>If the save is initiated via SCPI, and the file already exists, the file will be overwritten.</p> <p>Using the C: drive is strongly discouraged, since it runs the risk of being overwritten during an instrument software upgrade. Both single and double quotes are supported for any filename parameter over remote.</p>
SCPI Status Bits/OPC Dependencies	Sequential - waits for previous measurement to complete
Key Path	Save, Data, To File, Save As
Mode	NFIGURE

Save

Instrument S/W Revision A.02.00

Remote Command :MMEMory:STORe:CAPTured <filename>

Example :MMEM:STOR:CAPT
"MyDocuments\WCDMA\data\captureBuffer\myCaptureBuffer.bin" saves the capture buffer data from the current measurement to the file myCaptureBuffer.bin in the default path.

Restriction and Notes If the file already exists, the file will be overwritten.

Using the C: drive is strongly discouraged, since it runs the risk of being overwritten during a instrument software upgrade. Both single and double quotes are supported for any filename parameter over remote.

Key Path **Save, Data, Save As**

Mode WCDMA

Instrument S/W Revision Prior to A.02.00

Remote Command :MMEMory:STORe:ZMAP <filename>

Example :MMEM:STOR:ZMAP "myZoneMap.omf" saves current Zone map as 89601 compatible file type.

Restriction and Notes If a file with the same name already exists, the file will be overwritten. Using the C: drive is strongly discouraged, since it runs the risk overwriting the file during a instrument software upgrade. Both single and double quotes are supported for any filename parameter over remote.

Once a save is complete, the Export Data menu will appear, and the Save As dialog will disappear.

The message "File <file name> saved" will appear after the save is complete.

Key Path **Save, Data, Zone map**

Mode WIMAXOFDMA

Instrument S/W Revision Prior to A.02.00

Remote Command :MMEMory:STORe:RECOrding
<filename> [, SDF | SDFX | CSV | TXT | MAT4 | MAT | HDF5 | BIN [, OFF | ON | 0 | 1 [, OFF | ON | 0 | 1 [, OFF | ON | 0 | 1]]]]

Example MMEM:STOR:REC "MyRecording.sdf",SDF,ON,ON,OFF

Remote Command Notes

Recorded data must be available in the buffer.

File format is selected by the second parameter, but no default extension is appended to the filename. If the second parameter is not supplied, then the filename extension is used to determine the format. *.mat selects Matlab 5 format. *.sdf, or an unrecognized extension chooses the SDF fast format.

The three optional Booleans determine if:

1. file is saved with headers
2. data is resampled to the current span before saving
3. player position settings limit the data saved

Mode

VSA

Instrument S/W Revision

Prior to A.02.00

Screen Image

Accesses a menu of functions that enable you to specify a format and location for the saved screen image.

Pressing Screen Image brings up a menu which allows you to specify the color scheme of the Screen Image (Themes) or navigate to the Save As dialog to perform the actual save.

Screen Image files contain an exact representation of the analyzer display. They cannot be loaded back onto the analyzer, but they can be loaded into your PC for use in many popular applications.

The image to be saved is actually captured when the **Save** front-panel key is pressed, and kept in temporary storage to be used if you ask for a Screen Image save. When the Screen Image key is pressed, a "thumbnail" of the captured image is displayed, as shown below:

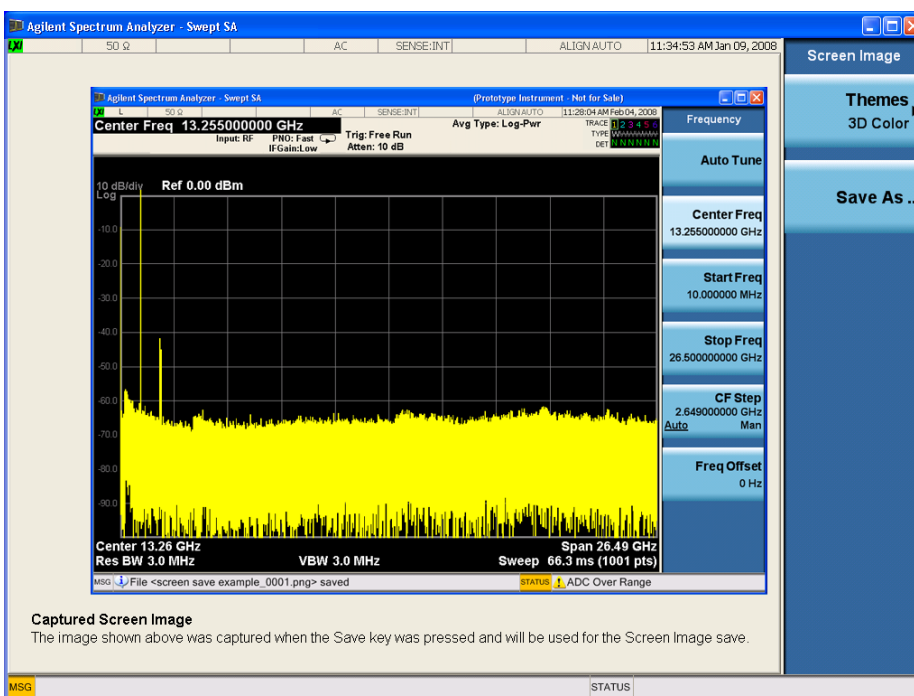

Save

When you continue on into the **Save As** menu and complete the Screen Image save, the image depicted in the thumbnail is the one that gets saved, showing the menus that were on the screen before going into the **Save** menus.

After you have completed the save, the **Quick Save** front-panel key lets you quickly repeat the last save performed, using an auto-named file, with the current screen data.

NOTE For versions previous to A.01.55, if you initiate a screen image save by navigating through the Save menus, the image that is saved will contain the Save menu keys, not the menus and the active function that were on the screen when you first pressed the Save front-panel key.

Example	MMEM:STOR:SCR "MyScreenFile.png" This stores the current screen image in the file MyScreenFile.png in the default directory.
Remote Command Notes	See “Save” on page 606
Key Path	Save
Mode	All
Instrument S/W Revision	Prior to A.02.00

Themes

Accesses a menu of function that enable you to choose the theme to be used when saving the screen image.

The **Themes** option is the same as the **Themes** option under the **Display** and **Page Setup** dialogs. It allows you to pick between themes to be used when saving the screen image.

Remote Command	:MMEMory:STORe:SCReen:THEMe TDCOLOR TDMonochrome FCOLOR FMONochrome :MMEMory:STORe:SCReen:THEMe?
Example	:MMEM:STOR:SCR:THEM TDM
Key Path	Save, Screen Image
Preset	3D Color; Is not part of Preset, but is reset by Restore Misc Defaults or Restore System Defaults All and survives subsequent running of the modes
Readback	3D Color 3D Mono Flat Color Flat Mono
Instrument S/W Revision	Prior to A.02.00

3D Color

Selects a standard color theme with each object filled, shaded and colored as designed.

Example	MMEM:STOR:SCR:THEM TDC
Key Path	Save, Screen Image, Themes
Readback	3D Color
Instrument S/W Revision	Prior to A.02.00

3D Monochrome

Selects a format that is like 3D color but shades of gray are used instead of colors.

Example	MMEM:STOR:SCR:THEM TDM
Key Path	Save, Screen Image, Themes
Readback	3D Mono
Instrument S/W Revision	Prior to A.02.00

Flat Color

Selects a format that is best when the screen is to be printed on an ink printer.

Example	MMEM:STOR:SCR:THEM FCOL
Key Path	Save, Screen Image, Themes
Readback	Flat Color
Instrument S/W Revision	Prior to A.02.00

Flat Monochrome

Selects a format that is like Flat Color. But only black is used (no colors, not even gray), and no fill.

Example	MMEM:STOR:SCR:THEM FMON
Key Path	Save, Screen Image, Themes
Readback	Flat Mono
Instrument S/W Revision	Prior to A.02.00

Save As...

Accesses a menu that enables you to select the location where you can save the Screen Image. This menu is a standard Windows® dialog with Save As menu keys. The **Save As** dialog is loaded with the file information related to the Screen Image Type. The filename is filled in using the auto file naming algorithm for the Screen Image Type and is highlighted. The only files that are visible are the *.png files and the Save As Type is *.png, since .png is the file suffix for the Screen Image Type.

Save

The default path for Screen Images is

My Documents\<mode name>\screen.

where <mode name> is the parameter used to select the mode with the INST:SEL command (for example, SA for the Spectrum Analyzer).

This path is the **Save In:** path in the **Save As** dialog for all Screen Files when you first enter this dialog.

Restriction and Notes	Brings up Save As dialog for saving a Screen Image Save Type
Key Path	Save, Screen Image
Instrument S/W Revision	Prior to A.02.00

Save

Saves the screen image to the specified file using the selected theme. The image that is saved is the measurement display prior to when the **Save As** dialog appeared. The save is performed immediately and does not wait until the measurement is complete.

Remote Command: :MMEMory:STORe:SCReen <filename>

Example: :MMEM:STOR:SCR "myScreen.png"

Restriction and Notes: If the file already exists, the file will be overwritten. Using the C: drive is strongly discouraged, since it runs the risk of being overwritten during a instrument software upgrade. Both single and double quotes are supported for any filename parameter over remote.

Auto return to the Screen Image menu and the Save As dialog goes away.

Advisory Event "File <file name> saved" after save is complete.

Key Path: **Save, Screen Image, Save As...**

Instrument S/W Revision: Prior to A.02.00

Save As . . .

The **Save As** is a standard Windows dialog and with the **Save As** key menu. The "File Name" field in the Save As dialog is initially loaded with an automatically generated filename specific to the appropriate Save Type. The automatically generated filename is guaranteed not to conflict with any filename currently in the directory. You may replace or modify this filename using the File Name key. See the Quick Save key documentation for more on the automatic file naming algorithm.

The **Save As** dialog will have the last path loaded in **Save In:** for this particular file type. User specified paths are remembered and persist through subsequent runs of the mode. These remembered paths are mode specific and are reset back to the default using **Restore Mode Defaults**.

Instrument S/W Revision Prior to A.02.00

Save

Performs the actual save to the specified file of the selected type. The act of saving does not affect the currently running measurement and does not require you to be in single measurement mode to request a save. It performs the save as soon as the currently running measurement is in the idle state; when the measurement completes. This ensures the State or Data that is saved includes complete data for the current settings. The save only waits for the measurement to complete when the state or data that depends on the measurement setup is being saved. The save happens immediately when exporting corrections or when saving a screen image.

If the file already exists, a dialog will popup with corresponding menu keys that allows you to replace the existing file with an **OK** or to **Cancel** the request.

While the save is being performed, the floppy icon shows up in the settings bar near the Continuous/Single icon. After the save completes, the corresponding register menu key annotation is updated with the date the time and the message "File <file name> saved" appears in the message bar.

Restriction and Notes:	If the file already exists, the File Exist dialog pops up and allows you to replace it or not by selecting the Yes or No menu keys that appear with the dialog. Then the key causes an auto return and Save As dialog goes away. Advisory Event "File <file name> saved" after save is complete.
------------------------	---

Instrument S/W Revision:	Prior to A.02.00
--------------------------	------------------

File/Folder List

Enables you to navigate to the center of the dialog that contains the list of files and folders. Once here you can get information about the file.

Restriction and Notes	Pressing this key navigates you to the files and folders list in the center of the dialog.
-----------------------	--

Key Path	Save, <various>, Save As...
----------	--

Instrument S/W Revision	Prior to A.02.00
-------------------------	------------------

File Name

Brings up the Alpha Editor as shown in the screen image. Use the knob to choose the letter to add and the Enter front-panel key to add the letter to the file name. In addition to the list of alpha characters, this editor includes a **Space** menu key and a **Done** menu key. The **Done** menu key completes the filename, removes the Alpha Editor and returns back to the **File Open** dialog and menu, but does not cause the save to occur. You can also use **Enter** to complete the file name entry and this will cause the save to occur.

Restriction and Notes	Brings up the Alpha Editor. Editor created file name is loaded in the File name field of the Save As dialog.
-----------------------	--

Key Path	Save, <various>, Save As...
----------	--

Instrument S/W Revision	Prior to A.02.00
-------------------------	------------------

Save

Save As Type

This key corresponds to the **Save As Type** selection in the dialog. It follows the standard Windows® supported **Save As Type** behavior. It shows the current file suffix that corresponds to the type of file you have selected to save. If you navigated here from saving State, "State File (*.state)" is in the dialog selection and is the only type available under the pull down menu. If you navigated here from saving Trace, "Trace+State File (*.trace)" is in the dialog selection and is the only type available under the pull down menu. If you navigated here from exporting a data file, "Data File (*.csv)" is in the dialog and is available in the pull down menu. Modes can have other data file types and they would also be listed in the pull down menu.

Restriction and Notes	Pressing this key causes the pull down menu to list all possible file types available in this context. All types available are loaded in a 1-of-N menu key for easy navigation.
Key Path	Save, <various>, Save As...
Instrument S/W Revision	Prior to A.02.00

Up One Level

This key corresponds to the icon of a folder with the up arrow that is in the tool bar of the dialog. It follows the standard Windows® supported **Up One Level** behavior. When pressed, it causes the file and folder list to navigate up one level in the directory structure.

Restriction and Notes	When pressed, the file and folder list is directed up one level of folders and the new list of files and folders is displayed
Key Path	Save, <various>, Save As...
Instrument S/W Revision	Prior to A.02.00

Create New Folder

This key corresponds to the icon of a folder with the "*" that is in the tool bar of the dialog. It follows the standard Windows® supported **Create New Folder** behavior. When pressed, a new folder is created in the current directory with the name **New Folder** and allows you to enter a new folder name using the Alpha Editor.

Restriction and Notes	Creates a new folder in the current folder and lets you fill in the folder name using the Alpha Editor.
Key Path	Save, <various>, Save As...
Instrument S/W Revision	Prior to A.02.00

Cancel

This key corresponds to the **Cancel** selection in the dialog. It follows the standard Windows supported **Cancel** behavior. It causes the current **Save As** request to be cancelled.

Restriction and Notes Pressing this key causes the Save As dialog to go away and auto return.

Key Path **Save, <various>, Save As...**

Instrument S/W Revision Prior to A.02.00

Save

Single (Single Measurement/Sweep)

Single sets the analyzer for Single measurement operation. The single/continuous state is Meas Global, so the setting will affect all the measurements. If you are Paused, pressing **Single** does a Resume.

Example:	:INIT:CONT OFF
Remote Command Notes:	See Cont key description.
Key Path:	Front-panel key
Instrument S/W Revision:	Prior to A.02.00

Single (Single Measurement/Sweep)

Source

This mode does not have any Source control functionality.

Key Path	Front-panel key
Instrument S/W Revision	Prior to A.02.00

Source

SPAN X Scale

Span features are unique to each Measurement. See the specific Measurement for more information.

The front panel key accesses keys to control span (or X-axis) settings.

Key Path	Front-panel key
Instrument S/W Revision	Prior to A.02.00

SPAN X Scale

Sweep / Control

This section describes the keys in the Sweep, Control and Capture menu that are common to multiple Modes and Measurements. See the Measurement descriptions for information on features that are unique.

The Meas Uncal (measurement uncalibrated) warning is given in the Status Bar in the lower right corner of the screen when the manual sweep time entered is too fast to give accurate measurements with the current setting of Res BW. When this happens, increase the Sweep Time or the Res BW.

Key Path	Front-panel key
Instrument S/W Revision	Prior to A.02.00

Abort (Remote Command Only)

This command is used to stop the current measurement. It aborts the current measurement as quickly as possible, resets the sweep and trigger systems, and puts the measurement into an "idle" state. If the analyzer is in the process of aligning when ABORt is sent, the alignment finishes before the abort function is performed. So ABORt does not abort an alignment.

If the analyzer is set for Continuous measurement, it sets up the measurement and initiates a new data measurement sequence with a new data acquisition (sweep) taken once the trigger condition is met.

If the analyzer is set for Single measurement, it remains in the "idle" state until an :INIT:IMM command is received.

Remote Command:	:ABORt
Example:	:ABOR
Dependencies/Couplings:	For continuous measurement, ABORt is equivalent to the Restart key. Not all measurements support the abort command.
Remote Command Notes:	If :INITiate:CONTinuous is ON, then a new continuous measurement will start immediately; with sweep (data acquisition) occurring once the trigger condition has been met. If :INITiate:CONTinuous is OFF, then :INITiate:IMMEDIATE is used to start a single measurement; with sweep (data acquisition) occurring once the trigger condition has been met.
SCPI Status Bits/OPC Dependencies:	The STATus:OPERation register bits 0 through 8 are cleared. The STATus:QUESTionable register bit 9 (INTegrity sum) is cleared. Since all the bits that feed into OPC are cleared by the ABORt, the ABORt will cause the *OPC query to return true.
Instrument S/W Revision:	Prior to A.02.00

Sweep / Control

Pause/Resume

Pauses a measurement after the current data acquisition is complete.

When Paused, the label on the key changes to Resume. Pressing Resume un-pauses the measurement. When you are Paused, pressing **Restart**, **Single** or **Cont** does a Resume.

Remote Command:	:INITiate:PAUSE
Dependencies/Couplings:	Grayed out in Measurements that don't support Pausing. Blanked in Modes that don't support Pausing.
Key Path:	Sweep/Control
Instrument S/W Revision:	Prior to A.02.00

Remote Command:	:INITiate:RESume
Dependencies/Couplings:	Grayed out in Measurements that don't support Pausing. Blanked in Modes that don't support Pausing.
Key Path:	Sweep/Control
Instrument S/W Revision:	Prior to A.02.00

Gate

The Gate key in the Sweep/Control menu accesses a menu that enables you to control the gating function.

The Gate functionality is used to view signals best viewed by qualifying them with other events. Gate setup parameters are meas global, so the settings will be the same in all the measurements.

Sweep Time autocoupling rules and annotation are changed by Gate being on.

Key Path	Sweep/Control
Readback	The state and method of Gate, as [Off, LO] or [On, Video]. Note that for measurements that only support gated LO, the method is nonetheless read back, but always as LO.
Instrument S/W Revision	Prior to A.02.00

Gate On/Off

Turns the gate function on and off.

When the Gate Function is on, the selected Gate Method is used along with the gate settings and the signal at the gate source to control the sweep and video system with the gate signal. Not all measurements allow every type of Gate Methods.

When Gate is on, the annunciation in the Meas Bar reflects that it is on and what method is used, as seen in the "Gate: LO" annunciator below.

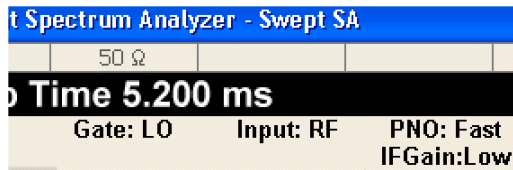

Remote Command:	[:SENSe] :SWEep:EGATe [:STATe] OFF ON 0 1 [:SENSe] :SWEep:EGATe [:STATe] ?
Example:	SWE:EGAT ON SWE:EGAT?
Dependencies/Couplings:	The function is unavailable (grayed out) and Off when: Gate Method is LO or Video and FFT Sweep Type is manually selected. Gate Method is FFT and Swept Sweep Type is manually selected. Marker Count is ON. When Meas Method is RBW or FAST, this function is unavailable and the key is grayed out. Whenever Gate is on, Meas Method, RBW or FAST is unavailable and keys for those are grayed out. When Gate is on, Offset Res BW and Offset Video BW is ignored (if user sets these values) and measurement works like as all Offset Res BW and all Offset Video BW are coupled with Res BW and Video BW under BW menu. When Gate is on, Offset BW key in Offset/Limit menu is grayed out.
Preset:	Off
Range:	On Off
State Saved:	Saved in State
Key Path:	Sweep/Control, Gate
Instrument S/W Revision:	Prior to A.02.00

Sweep / Control

Gate View On/Off

Turning on Gate View in the Swept SA measurement provides a single-window gate view display.

Turning on Gate View in other measurements shows the split-screen Gate View. In these measurements, when the Gate View is on, the regular view of the current measurement traces and results are reduced vertically to about 70% of the regular height. The Zero Span window showing the positions of the Gate is shown between the Measurement Bar and the reduced measurement window. By reducing the height of the measurement window, some of the annotation on the Data Display may not fit and is not shown.

Remote Command [:SENSe]:SWEep:EGATe:VIEW ON|OFF|1|0

[:SENSe]:SWEep:EGATe:VIEW?

Example SWE:EGAT:VIEW ON turns on the gate view.

Dependencies/Couplings These couplings apply to the Swept SA measurement:

- When Gate View is turned on, the instrument is set to Zero Span.
- Gate View automatically turns off whenever a Span other than Zero is selected.
- Gate View automatically turns off if you press Last Span while in Gate View, and the instrument returns to the Span it was in before entering Gate View (even if that is Zero Span).

When Gate View is turned on, the sweep time used is the gate view sweep time. This is set according to the rules in [“Gate View Sweep Time” on page 630](#).

- When Gate View is turned off, Sweep Time is set to the normal Swept SA measurement sweep time.
- If Gate View is on and Gate is off, then turning on Gate turns off Gate View.

In the Swept SA measurement:

In Gate View, the regular Sweep Time key is grayed out, to avoid confusing you when you want to set Gate View Sweep Time.

In the other measurements:

When you turn Gate View on, the lower window takes on the current state of the instrument. Upon leaving Gate View, the instrument takes on the state of the lower window.

- When you turn Gate View on, the upper window Sweep Time is set to the gate view sweep time.

Key Path **Sweep/Control, Gate**

Preset OFF

State Saved Saved in state

Range On|Off

Instrument S/W Revision Prior to A.02.00

A sample of the Gate View screen in the Swept SA measurement is shown below:

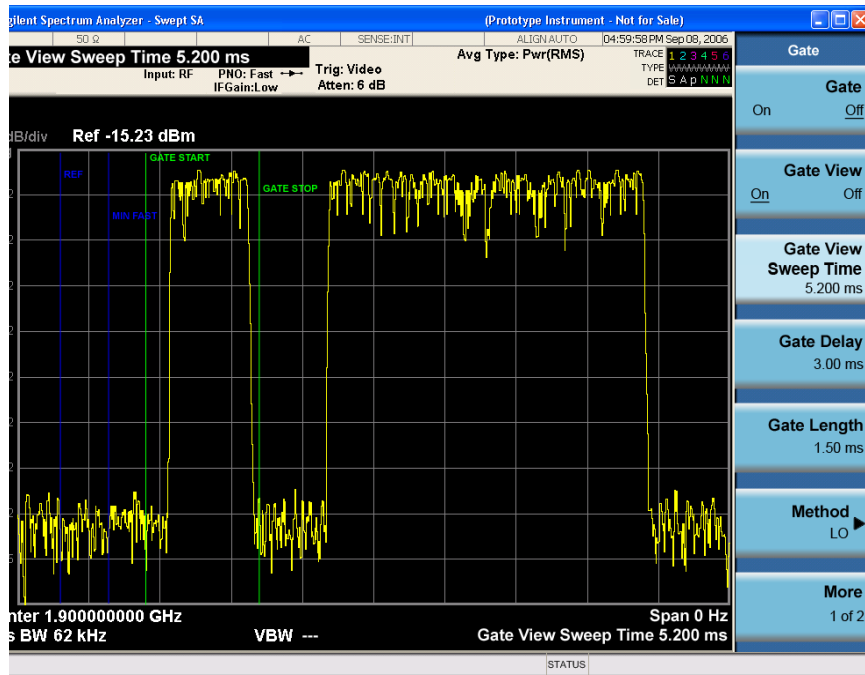

A sample of the Gate View screen in other measurements is shown below. This example is for the ACP measurement:

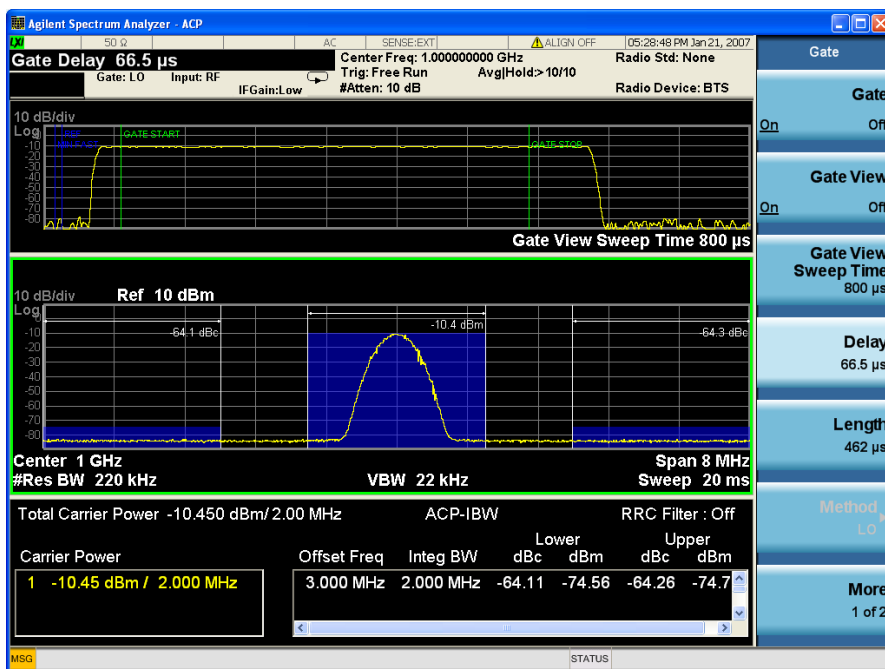

Turning Gate View off returns the analyzer to the Normal measurement view.

Sweep / Control

In the Swept SA, the normal measurement view is the single-window Swept SA view. When returning to this view, the Swept SA measurement returns to the Span it was in before entering **Gate View** (even if that is Zero Span).

The **Gate View** window is triggered from the Gate Source, with zero trigger delay. Also, when updating the **Gate View** window, the Gate itself must not operate. So it is internally shut off while the gate view window is being updated. For the Swept SA measurement, this means that the Gate is internally shut off whenever the gate view window is displayed. The Meas Bar and keys continue to show the Trigger source for the main sweep window and give no indication that the Gate is shut off or that the Gate View window is triggered from the Gate Source.

When in **Gate View**, vertical lines are displayed in the Gate View window as follows:

- Green lines are displayed at the gate edges as follows: in Edge Gate, a line is shown for Delay and one for the end of the Gate period (defined by Length, even in FFT. In Level Gate a line is shown only for Delay. You can adjust the position of the green lines by adjusting the gate length and the gate delay. These lines update in the Gate View window as the active function changes, even if the window is not being updated. In Gated LO and Gated Video, these lines are positioned relative to the delay reference line (not relative to 0 time). In Gated FFT, their location is relative to the left edge of the screen.
- A blue line is displayed showing the delay reference, that is, the reference point for the Gate Delay within the Zero Span window. The blue line represents where (in time) the effective location of the gate start would be if the gate were programmed to zero delay.
- The second blue line is labeled "MIN FAST" as shown in the figure above because it represents the minimum Gate Delay for fast Gated LO operation. This line is only displayed in Gated LO. You cannot scroll (knob) or decrement (down key) the Gate Delay to less than that represented by the position of this line, it can only be set below this position manually, although once there it can be moved freely with the knob while below the line.
- A yellow line in the Gated Video case only, is displayed at Blength, where Blength is the bucket length for the swept trace, which is given by the sweep time for that trace divided by number of Points – 1. So it is referenced to 0 time, not to the delay reference. This line is labeled NEXT PT (it is not shown in the figure above because the figure above is for Gated LO). The yellow line represents the edge of a display point (bucket). Normally in Gated Video, the bucket length must be selected so that it exceeds the off time of the burst. There is another way to use the analyzer in Gated Video measurements, and that is to set the bucket width much shorter than the off time of the burst. Then use the Max Hold trace function to fill in "missing" buckets more slowly. This allows you to see some of the patterns of the Gated Video results earlier, though seeing a completely filled-in spectrum later.

Gate View Sweep Time

Controls the sweep time in the Gate View window. In order to provide an optimal view of the gate signal, the analyzer initializes Gate View Sweep Time based on the current settings of Gate Delay and Gate Length.

Remote Command: [:SENSE] :SWEep:EGATe:TIME <time>
 [:SENSE] :SWEep:EGATe:TIME?

Example: SWE:EGAT:TIME 500 ms

Dependencies/Couplings:	Gate View Sweep Time is initialized: on Preset (after initializing delay and length). every time the Gate Method is set/changed. Additionally, in the Swept SA measurement, whenever you do a Preset, or leave Gate View, the analyzer remembers the Gate Delay and Gate Length settings. Then, when returning to Gate View, if the current Gate Delay and/or Gate Length do not match the remembered values Gate View Sweep Time is re-initialized. 1. Compute the location of the "gate stop" line, which you know is at time $t = t_{min} + GateDelay + GateLength$.
Preset:	519.3 μ s WiMAX OFDMA: 5 ms GSM/EDGE: 1 ms
State Saved:	Saved in state
Min:	1 μ s
Max:	6000 s
Key Path:	Sweep/Control, Gate
Instrument S/W Revision:	Prior to A.02.00

Gate Delay

Controls the length of time from the time the gate condition goes True until the gate is turned on.

Remote Command:	[:SENSe] :SWEep:EGATe:DELAy <time> [:SENSe] :SWEep:EGATe:DELAy?
Example:	SWE:EGAT:DELAy 500ms SWE:EGAT:DELAy?
Remote Command Notes:	Units of time are required or no units; otherwise an invalid suffix error will be generated. See error -131.
Preset:	57.7 us WiMAX OFDMA: 71 us GSM/EDGE: 600 us
State Saved:	Saved in state
Min:	0.0 us
Max:	100 s
Key Path:	Sweep/Control, Gate
Instrument S/W Revision:	Prior to A.02.00

Sweep / Control

Gate Length

Controls the length of time that the gate is on after it opens.

Remote Command: [:SENSe]:SWEep:EGATe:LENGth <time>
[:SENSe]:SWEep:EGATe:LENGth?

Example: SWE:EGAT:LENG 1
SWE:EGAT:LENG?

Dependencies/Couplings: Grayed out when Gate Method is set to FFT in which case the label changes to that shown below.



Gate Length
(=1.83/RBW)
2.8 ms

vsd 39-1

The key is also grayed out if Gate Control = Level.

Remote Command Notes: Units of time are required or no units; otherwise an invalid suffix will be generated.

Preset: 461.6 us
WiMAX OFDMA: 50 us
GSM/EDGE: 200 us

State Saved: Saved in state

Min: 100 ns

Max: 5 s

Key Path: **Sweep/Control, Gate**

Instrument S/W Revision: Prior to A.02.00

Method

This lets you choose one of the three different types of gating.

Not all types of gating are available for all measurements.

Remote Command: [:SENSe]:SWEep:EGATe:METhod LO|VIDeo|FFT
[:SENSe]:SWEep:EGATe:METhod?

Example: SWE:EGAT:METH FFT

Preset: LO

State Saved: Saved in state

Key Path: **Sweep/Control, Gate**

Instrument S/W Revision: Prior to A.02.00

LO

When set to Gate (On), the LO sweeps whenever the gate conditions as specified in the Gate menu are satisfied by the signal at the Gate Source.

This form of gating is more sophisticated, and results in faster measurements. With Gated LO, the analyzer only sweeps while the gate conditions are satisfied. This means that a sweep could take place over several gate events. It would start when the gate signal goes true and stop when it goes false, then continue when it goes true again. But since the LO is sweeping as long as the gate conditions are satisfied, the sweep typically finishes much more quickly than with Gated Video.

When in zero span, there is no actual sweep performed. But data is only taken while the gate conditions are satisfied. So even though there is no sweep, the gate settings will impact when data is acquired.

Dependencies/Couplings:	Key is unavailable when Gate is On and FFT Sweep Type manually selected. When selected, Sweep Type is forced to Swept and the FFT key in Sweep Type is grayed out.
Key Path:	Sweep/Control, Gate, Method
Readback:	LO
Instrument S/W Revision:	Prior to A.02.00

Video

When set to Gate (On), the video signal is allowed to pass through whenever the gate conditions as specified in the Gate menu are satisfied by the signal at the Gate Source.

This form of gating may be thought of as a simple switch, which connects the signal to the input of the spectrum analyzer. When the gate conditions are satisfied, the switch is closed, and when the gate conditions are not satisfied, the switch is open. So we only look at the signal while the gate conditions are satisfied.

With this type of gating, you usually set the analyzer to sweep very slowly. In fact, a general rule is to sweep slowly enough that the gate is guaranteed to be closed at least once per bucket (data measurement interval). Then if the peak detector is used, each bucket will represent the peak signal as it looks with the gate closed.

Dependencies/Couplings:	Key is unavailable when Gate is On and FFT Sweep Type manually selected. When selected, Sweep Type is forced to Swept and the FFT key in Sweep Type is grayed out
Key Path:	Sweep/Control, Gate, Method
Readback:	Video
Instrument S/W Revision:	Prior to A.02.00

Sweep / Control

FFT

When set to Gate (On), the an FFT is performed whenever the gate conditions as specified in the Gate menu are satisfied by the signal at the Gate Source. This is an FFT measurement which begins when the gate conditions are satisfied. Since the time period of an FFT is approximately 1.83/RBW, you get a measurement which starts under predefined conditions and takes place over a predefined period. So, in essence, this is a gated measurement. You have limited control over the gate length but it works in FFT sweeps, which the other two methods do not.

Gated FFT cannot be done in zero span since the instrument is not sweeping. So in zero span the Gated LO method is used. Data is still only taken while the gate conditions are satisfied, so the gate settings do impact when data is acquired.

The Gate Length will be 1.83/RBW.

This is a convenient way to make a triggered FFT measurement under control of an external gating signal.

Dependencies/Couplings:	Key is unavailable when Gate is On and Swept Sweep Type manually selected. Key is unavailable when gate Control is set to Level. When selected, Sweep Type is forced to FFT and the Swept key in Sweep Type is grayed out Forces Gate Length to 1.83/RBW (see Length key description above)
Key Path:	Sweep/Control, Gate
Readback:	FFT
Instrument S/W Revision:	Prior to A.02.00

Gate Source

The menus under the **Gate Source** key follow the same pattern as those under **Trigger**, with the exception that neither **Free Run** nor **Video** are available as Gate Source selections. Any changes to the settings in the setup menus under each Gate Source selection key (for example: **Trigger Level**) also affect the settings under the Trigger menu keys. Note that the selected Trigger Source does not have to match the Gate Source.

Remote Command:	<code>[:SENSe] :SWEep:EGATe:SOURce EXTernal1 EXTernal2 LINE FRAMe RFBurst TV [:SENSe] :SWEep:EGATe:SOURce?</code>
Preset:	EXTernal 1 GSM/EDGE: FRAMe
Key Path:	Sweep/Control, Gate
Dependencies/Couplings:	TV triggering is not available yet.
Instrument S/W Revision:	Prior to A.02.00

Control Edge/Level

Sets the method of controlling the gating function from the gating signal.

Edge

In Edge triggering, the gate opens (after the Delay) on the selected edge (for example, positive) of the gate signal and closes on the alternate edge (for example, negative).

Level

In Level triggering, the gate opens (after the Delay) when the gate signal has achieved a certain level and stays open as long as that level is maintained.

Remote Command: `[:SENSE] :SWEep:EGATe:CONTRol EDGE | LEVEL`

`[:SENSE] :SWEep:EGATe:CONTRol?`

Example: `SWE:EGAT:CONT EDGE`

Dependencies/Couplings: If the Gate Method is FFT the Control key is grayed out and Edge is selected.
If the Gate Source is TV, Frame or Line, the Control key is grayed out and Edge is selected.

Preset: `EDGE`

State Saved: Saved in stat

Key Path: **Sweep/Control, Gate**

Instrument S/W Revision: Prior to A.02.00

Gate Holdoff

Lets you increase or decrease the wait time after a gate event ends before the analyzer will respond to the next gate signal.

After any Gate event finishes, the analyzer must wait for the sweep system to settle before it can respond to another Gate signal. The analyzer calculates a "wait time," taking into account a number of factors, including RBW and Phase Noise Optimization setting. The goal is to achieve the same accuracy when gated as in ungated operation. The figure below illustrates this concept:

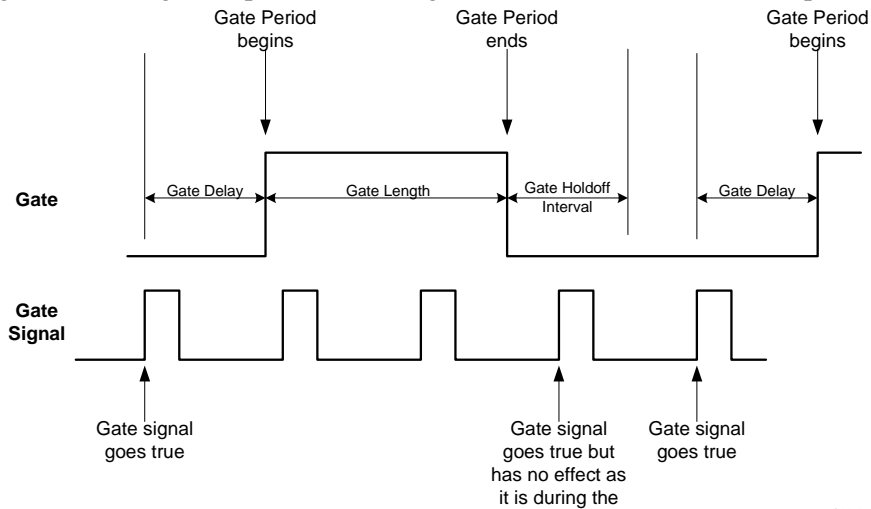

Sweep / Control

When Gate Holdoff is in Auto, the wait time calculated by the analyzer is used. When Gate Time is in Manual, you may adjust the wait time, usually decreasing it in order to achieve greater speed, but at the risk of decreasing accuracy.

When **Method** is set to **Video** or **FFT**, the **Gate Holdoff** function has no effect.

In measurements that do not support Auto, the value shown when Auto is selected is "---" and the manually set holdoff is returned to a query.

Remote Command

```
[ :SENSe ] :SWEep:EGATe:HOLDoff <time>
[ :SENSe ] :SWEep:EGATe:HOLDoff?
[ :SENSe ] :SWEep:EGATe:HOLDoff:AUTO OFF | ON | 0 | 1
[ :SENSe ] :SWEep:EGATe:HOLDoff:AUTO?
```

Dependencies/Couplings When **Gate Holdoff** is **Auto**, the **Gate Holdoff** key shows the value calculated by the analyzer for the wait time.

Pressing the **Gate Holdoff** key while it is in **Auto** and not selected, causes the key to become selected and allows you to adjust the value. If the value is adjusted, the setting changes to **Man**.

Pressing the **Gate Holdoff** key, while it is in **Auto** and selected, does not change the value of **Gate Holdoff**, but causes the setting to change to **Man**. Now you can adjust the value.

Pressing the key while it is in **Man** and selected, cause the value to change back to **Auto**.

Pressing the key while it is in **Man** and not selected, causes the key to become selected and allows you to adjust the value.

When **Method** is set to **Video** or **FFT**, the **Gate Holdoff** function has no effect.

Example

```
SWE:EGAT:HOLD 0.0002
SWE:EGAT:HOLD?
SWE:EGAT:HOLD:AUTO ON
SWE:EGAT:HOLD:AUTO?
```

Key Path **Sweep/Control, Gate**

Mode SA, WCDMA, C2K, WIMAX OFDMA, TD-SCDMA, 1xEVDO

Preset Auto
Auto/On

State Saved Saved in instrument state.

Min 1 µsec

Max 1 sec

Instrument S/W Revision Prior to A.02.00

Gate Delay Compensation

This function allows you to select an RBW-dependent value by which to adjust the gate delay, to compensate for changes in the delay caused by RBW effects. The intent is to make it unnecessary for you to worry about the effects that RBW will have on the gate circuitry, by automatically compensating for them.

You can select between uncompensated operation and two types of compensation, **Delay Until RBW Settled** and **Compensate for RBW Group Delay**.

See [“More Information” on page 638](#)

Remote Command:	[:SENSE] :SWEep:EGATe:DELAy:COMPensation:TYPE OFF SETTled GDELAy [:SENSE] :SWEep:EGATe:DELAy:COMPensation:TYPE?
Example:	SWE:EGAT:DEL:COMP:TYPE SETT SWE:EGAT:DEL:COMP:TYPE?
Scope:	Meas Global
Range:	Uncompensated Delay Until RBW Settled Compensate for RBW Group Delay
Readback text:	Uncompensated Settled Group Delay
Preset:	TD-SCDMA mode: Compensate for RBW Group Delay All other modes: Delay Until RBW Settled
State Saved:	Saved in state
Key Path:	Sweep/Control, Gate
Notes:	<p>Although this function is Meas Global, there are some measurements that do not support this function. In those measurements the operation will be Uncompensated. Going into one of those measurements will not change the Meas Global selection; it will simply display the grayed-out menu key with “Uncompensated” showing as the selection. This is a non-forceful grayout, so the SCPI command is still accepted.</p> <p>If Gate Delay Compensation is not supported at all within a particular mode, the key is not displayed, and if the SCPI command is sent while in a measurement within that mode, an “Undefined Header” error is generated.</p> <p>Measurements that do not support this function include:</p> <p>Swept SA</p>
Instrument S/W Revision:	Prior to A.02.00

More Information

Selecting **Uncompensated** means that the actual gate delay is as you set it.

Selecting **Delay Until RBW Settled** causes the gate delay to be increased above the user setting by an amount equal to $3.06/\text{RBW}$. This compensated delay causes the GATE START and GATE STOP lines on the display to move by the compensation amount, and the actual hardware gate delay to be increased by the same amount. All the other gate lines (for example, MIN FAST) are unaffected. If the RBW subsequently changes, the compensation is readjusted for the new RBW. The value shown on the **Gate Delay** key does NOT change.

Delay Until RBW Settled allows excellent measurements of gated signals, by allowing the IF to settle following any transient that affects the burst. Excellent measurements also require that the analysis region not extend into the region affected by the falling edge of the burst. Thus, excellent measurements can only be made over a width that declines with narrowing RBWs. Therefore, for general purpose compensation, you will still want to change the gate length with changes in RBW even if the gate delay is compensated.

Selecting **Compensate for RBW Group Delay** causes the gate delay to be increased above the user setting by an amount equal to $1.81/\text{RBW}$. This compensated delay causes the GATE START, GATE STOP lines on the display to move by the compensation amount, and the actual hardware gate delay to be increased by the same amount. All the other gate lines (for example, MIN FAST) are unaffected. If the RBW subsequently changes, the compensation is readjusted for the new RBW. The value shown on the **Gate Delay** key does NOT change. **Compensate for RBW Group Delay** also includes gate length compensation; the gate length itself is adjusted as necessary to attempt to compensate for delay effects imposed by the RBW.

Compensate for RBW Group Delay is similar to **Delay Until RBW Settled**, but compensates for the group delay of the RBW filter, rather than the filter settling time. As the RBW gets narrow, this can allow the settling tail of the RBW to affect the beginning part of the gated measurement, and allow the beginning of the RBW settling transient to affect the end of the gated measurement. These two effects are symmetric because the RBW response is symmetric. Because the gate length is not automatically compensated, some users might find this compensation to be more intuitive than compensation for RBW settling.

Min Fast Position Query (Remote Command Only)

This command queries the position of the MIN FAST line, relative to the delay reference (REF) line. See section [“Gate View On/Off” on page 628](#). If this query is sent while not in gate view, the MinFast calculation is performed based on the current values of the appropriate parameters and the result is returned. Knowing this value lets you to set an optimal gate delay value for the current measurement setup.

Remote Command: `[:SENSE] :SWEp :EGATe :MINFast?`

Example: `SWE:EGAT:MIN?`

Instrument S/W Revision: `Prior to A.02.00`

Trace / Detector

Trace/Detector features are unique to each Measurement. See the specific Measurement for more information.

The front panel key accesses keys to control Trace and Detector settings.

Key Path	Front-panel key
Instrument S/W Revision	Prior to A.02.00

Trigger

The Trig front-panel key accesses a menu of keys to control the selection of the trigger source and the setup of each of the trigger sources. The analyzer is designed to allow triggering from a number of different sources, for example, Free Run, Video, External, RF Burst, etc.

The TRIG:SOURCe command (below) will specify the trigger source for the currently selected input (RF or I/Q). If you change inputs, the new input remembers the trigger source it was last programmed to for the current measurement, and uses that trigger source. You can directly set the trigger source for each input using the TRIGger:RF:SOURce and TRIGger:IQ:SOURce commands (later in this section).

Note the inclusion of the <measurement> parameter in the command below. Because each measurement remembers its own Trigger Source, the command must be qualified with the measurement name. Note that for the Swept SA measurement this is not the case; for backwards compatibility, no <measurement> parameter is used when setting the Trigger Source for the Swept SA measurement.

See [“Trigger Source Presets” on page 642](#)

See [“RF Trigger Source” on page 645](#)

See [“I/Q Trigger Source” on page 646](#)

See [“More Information” on page 647](#)

Remote Command

```
:TRIGger:<measurement>[:SEquence]:SOURce
EXTErnal1|EXTErnal2|IMMediate|LINE|FRAMe|RFBurst|VIDeo|
IF|ALARm|LAN|IQMag|IDEMod|QDEMod|IINPut|QINPut|AIQMag
:TRIGger:<measurement>[:SEquence]:SOURce?
```

Example

```
TRIG:ACP:SOUR EXT1
```

Selects the external 1 trigger input for the ACP measurement and the selected input

```
TRIG:SOUR VID
```

Selects video triggering for the SANalyzer measurement in the Spectrum Analyzer mode. For SAN, do not use the <measurement> keyword.

Trigger

Remote Command Notes	<p>Not all measurements have all the trigger sources available to them. Check the trigger source documentation for your specific measurement to see what sources are available.</p> <p>Not all trigger sources are available for each input. See the “RF Trigger Source” on page 645 and “I/Q Trigger Source” on page 646 commands (below) for detailed information on which trigger sources are available for each input.</p> <p>Other trigger-related commands are found in the INITiate and ABORt SCPI command subsystems.</p> <p>*OPC should be used after requesting data. This will hold off any subsequent changes to the selected trigger source, until after the sweep is completed and the data is returned.</p> <p>Available ranges and presets can vary from mode to mode.</p>
SCPI Status Bits/OPC Dependencies	<p>The Status Operation Register bit 5 "Waiting for Trigger" is set at the same time as the Sweeping or Measuring bit is set. It is cleared when the trigger actually occurs (that is, after the trigger event occurs and all the applicable trigger criteria have been met). A corresponding pop-up message ("Waiting for trigger") is generated if no trigger signal appears after approximately 2 sec. This message goes away when a trigger signal appears.</p>
Key Path	Front-panel key
Preset	See table below
Instrument S/W Revision	Prior to A.02.00

Trigger Source Presets

Here are the Trigger Source Presets for the various measurements:

Meas	Mode	Preset for RF	Preset for IQ	Notes
Swept SA	SA	IMM	IQ not supported	
CHP	SA, WCDMA, C2K, WIMAX OFDMA, 1xEVDO, DVB-T/H, DTMB	IMM	IQ not supported	

Meas	Mode	Preset for RF	Preset for IQ	Notes
OBW	SA, WCDMA, C2K, WIMAX OFDMA, TD-SCDMA, 1xEVDO	1xEVDO: EXT1 others: IMM	IQ not supported	For 1xEVDO mode, the trigger source is coupled with the gate state, as well as the gate source. When the trigger source changes to RFBurst, External1 or External2, the gate state is set to on, and the gate source is set identically with the trigger source. When the trigger source changes to IMMEDIATE, VIDEO, LINE, FRAME or IF, the gate state is set to off.
CCDF	SA, WCDMA, C2K, WIMAX OFDMA, TD-SCDMA, 1xEV-DO, DVB-T/H, DTMB	SA, WCDMA, C2K: IMMEDIATE WIMAX OFDMA: RFBurst TD-SCDMA: BTS: External 1 MS: RFBurst	TD-SCDMA: BTS: External 1 MS: IQMag Others: IMM	For TD-SCDMA: Trigger source is coupled with radio device. When radio device changes to BTS, trigger source will be changed to EXTERNAL1. When radio device changes to MS, trigger source will be set as RFBurst for RF or IQ Mag for BBIQ. When TriggerSource is RFBurst or IQ Mag, Measure Interval is grayed out.
ACP	SA, WCDMA, C2K, WIMAX OFDMA, TD-SCDMA, 1xEVDO, DVB-T/H, DTMB	IMM	IQ not supported	
Tx Power	SA, GSM, TD-SCDMA	SA, GSM: RFBurst TD-SCDMA: EXTERNAL	IMM	TD-SCDMA doesn't support the Line and Periodic Timer parameters. When the mode is TD-SCDMA, if the Radio Device is switched to BTS, the value will be changed to External 1 and if the Radio device is switched to MS, the value will be changed to RFBurst
SPUR	SA, WCDMA, C2K, WIMAX OFDMA, TD-SCDMA, 1xEV-DO, DVB-T/H	IMM	IQ not supported	

Trigger

Meas	Mode	Preset for RF	Preset for IQ	Notes
SEM	SA, WCDMA, C2K, WIMAX OFDMA, TD-SCDMA, 1xEVDO, DVB-T/H, DTMB	SA, WCDMA, C2K, TD-SCDMA, WIMAX OFDMA: IMMediate 1xEVDO(BTS): EXTernal1	IQ not supported	
CDP	WCDMA	IMM	IMM	
RHO	WCDMA	IMM	IMM	
PCON	WCDMA	IMM	IMM	
QPSK	WCDMA, C2K, 1xEVDO	All except CDMA1xEVDO: IMMediate CDMA1xEVDO: EXT1	IMM	
MON	All except SA and BASIC	IMM	IQ not supported	
WAV		All except GSM/EDGE: IMMediate GSM/EDGE: RFBurst	All except GSM/EDGE: IMMediate GSM/EDGE: IQMag	
PVT	WIMAX OFDMA	RFB	IMM	
EVM	WIMAX OFDMA, DVB-T/H, DTMB	IMM	IMM	
SPEC	BASIC	IMM	IMM	
LOG Plot	PN	IMM	IQ not supported	
Spot Freq	PN	IMM	IQ not supported	
GMSK PVT	EDGE/GSM	RFB	IMM	
GMSK PFER	EDGE/GSM	RFB	IQMag	
GMSK ORFS	EDGE/GSM	RFB	IQ not supported	
EDGE PVT	EDGE/GSM	RFB	IMM	

Meas	Mode	Preset for RF	Preset for IQ	Notes
EDGE EVM	EDGE/GSM	RFB	IQMag	
EDGE ORFS	EDGE/GSM	RFB	IQ not supported	
Combined WCDMA	WCDMA	IMM	IQ not supported	
Combined GSM	EDGE/GSM	RFB	IQ not supported	
List Power Step	WCDMA, EDGE/GSM	IMM	IQ not supported	

RF Trigger Source

The **RF Trigger Source** command (below) selects the trigger to be used for the specified measurement when RF is the selected input. The RF trigger source can be queried and changed even while another input is selected, but it is inactive until RF becomes the selected input.

Note the inclusion of the <measurement> parameter in the command below. Because each measurement remembers its own Trigger Source, the command must be qualified with the measurement name. Note that for the Swept SA measurement this is not the case; for backwards compatibility, no <measurement> parameter is used when setting the Trigger Source for the Swept SA measurement.

Remote Command: :TRIGger:<measurement>[:SEquence]:RF:SOURce
 EXTErnal1|EXTErnal2|IMMEdiate|LINE|FRAME|RFBurst|VIDeo|
 IF|ALARm|LAN
 :TRIGger:<measurement>[:SEquence]:RF:SOURce?

Example: TRIG:ACP:RF:SOUR EXT1
 Selects the external 1 trigger input for the ACP measurement and the RF input
 TRIG:RF:SOUR VID
 Selects video triggering for the SANalyzer measurement and the RF input.
 For SAN, do not use the <measurement> keyword.

Trigger

Remote Command Notes: Not all measurements have all the trigger sources available to them. Check the trigger source documentation for your specific measurement to see what sources are available.

Not all trigger sources are available for each input. For the **RF Trigger Source**, the following trigger sources are available:

- IMMEDIATE - free run triggering
- VIDEO - triggers on the video signal level
- LINE - triggers on the power line signal
- EXTERNAL1 - triggers on an externally connected trigger source on the rear panel
- EXTERNAL2 - triggers on an externally connected trigger source on the front panel
- RFBURST - triggers on the bursted frame
- FRAME - triggers on the periodic timer
- IF (video) - same as video, for backwards compatibility only
- ALARM – LXI Alarm
- LAN – LXI LAN event

*OPC should be used after requesting data. This will hold off any subsequent changes to the selected trigger source, until after the sweep is completed and the data is returned.

Available ranges, and presets can vary from mode to mode.

SCPI Status Bits/OPC Dependencies:

The Status Operation Register bit 5 "Waiting for Trigger" is set at the same time as the Sweeping or Measuring bit is set. It is cleared when the trigger actually occurs (that is, after the trigger event occurs and all the applicable trigger criteria have been met). A corresponding pop-up message ("Waiting for trigger") is generated if no trigger signal appears after approximately 2 sec. This message goes away when a trigger signal appears.

Instrument S/W Revision: Prior to A.02.00

I/Q Trigger Source

The **I/Q Trigger Source** command (below) selects the trigger to be used for the specified measurement when I/Q (which requires option BBA) is the selected input. The I/Q trigger source can be queried and changed even while another input is selected, but it is inactive until I/Q becomes the selected input.

Remote Command: :TRIGGER:<measurement>[:SEQUENCE]:IQ:SOURCE
EXTERNAL1|EXTERNAL2|IMMEDIATE|IQMAG|IDEMOD|QDEMOD|IINPUT|QINPUT|AIQMAG
:TRIGGER:<measurement>[:SEQUENCE]:IQ:SOURCE?

Example: TRIG:WAVEform:SOUR IQM
Selects I/Q magnitude triggering for the IQ Waveform measurement and the I/Q input

Remote Command Notes: Not all measurements have all the trigger sources available to them. Check the trigger source documentation for your specific measurement to see what sources are available.

Not all trigger sources are available for each input. For the **I/Q Trigger Source**, the following trigger sources are available:

- IMMEDIATE - free run triggering
- EXTERNAL1 - triggers on an externally connected trigger source on the rear panel
- EXTERNAL2 - triggers on an externally connected trigger source on the front panel
- IQMAG - triggers on the magnitude of the I/Q signal
- IDEMOD - triggers on the I/Q signal's demodulated I voltage
- QDEMOD - triggers on the I/Q signal's demodulated Q voltage
- IINPUT - triggers on the I channel's ADC voltage
- QINPUT - triggers on the Q channel's ADC voltage
- AIQMAG - triggers on the magnitude of the auxiliary receiver channel I/Q signal

*OPC should be used after requesting data. This will hold off any subsequent changes to the selected trigger source, until after the sweep is completed and the data is returned.

Available ranges, and presets can vary from mode to mode.

SCPI Status Bits/OPC Dependencies:

The Status Operation Register bit 5 "Waiting for Trigger" is set at the same time as the Sweeping or Measuring bit is set. It is cleared when the trigger actually occurs (that is, after the trigger event occurs and all the applicable trigger criteria have been met). A corresponding pop-up message ("Waiting for trigger") is generated if no trigger signal appears after approximately 2 sec. This message goes away when a trigger signal appears.

Instrument S/W Revision: Prior to A.02.00

More Information

The trigger menus let you select the trigger source and trigger settings for a sweep or measurement. In triggered operation (basically, any trigger source other than Free Run), the analyzer will begin a sweep or measurement only with the selected trigger conditions are met, generally when your trigger source signal meets the specified trigger level and polarity requirements. (In FFT measurements, the trigger controls when the data acquisition begins for FFT conversion.)

For each of the trigger sources, you may define a set of operational parameters or settings which will be applied when that source is selected as the current trigger source. Examples of these settings are Trigger Level, Trigger Delay, and Trigger Slope. You may apply different settings for each source; so, for example, you could have a Trigger Level of 1v for External 1 trigger and -10 dBm for Video trigger.

Once you have established the settings for a given trigger source, they generally will remain unchanged for that trigger source as you go from measurement to measurement within a Mode (although the settings do change as you go from Mode to Mode). Furthermore, the trigger settings within a Mode are the same

Trigger

for the **Trigger** menu, the **Gate Source** menu, and the **Sync Source** menu that is part of the **Periodic Timer Trigger Setup** menu. That is, if **Ext1** trigger level is set to 1v in the **Trigger** menu, it will appear as 1v in both the **Gate Source** and the **Sync Source** menus. For these reasons the trigger settings commands are not qualified with the measurement name, the way the trigger source commands are.

The settings setup menu can be accessed by pressing the key for the current trigger source a second time. For example, one press of Video selects the Video trigger as the source. The Video key becomes highlighted and the hollow arrow on the key turns black. Now a second press of the key takes you into the Video Trigger Setup menu.

Trigger Setup Parameters:

The following examples show trigger setup parameters using an external trigger source.

Example 1 illustrates the trigger conditions with negative slope and no trigger occurs during trigger Holdoff time.

Example 2 illustrates the trigger conditions with positive slope, trigger delay, and auto trigger time.

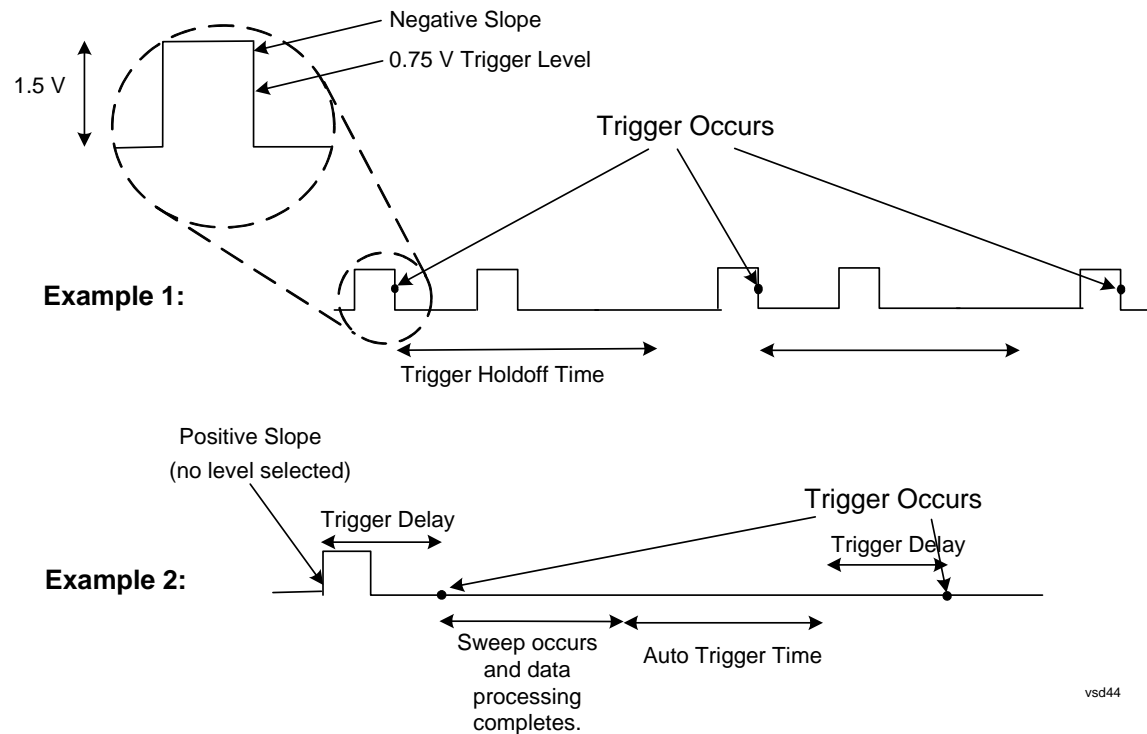

Free Run

Pressing this key, when it is not selected, selects free-run triggering. Free run triggering occurs immediately after the sweep/measurement is initiated.

Example: TRIG:SOUR IMM Swept SA measurement
TRIG:<meas>:SOUR IMM Measurements other than Swept SA

State Saved: Saved in instrument state.

Key Path:	Trigger
SCPI Status Bits/OPC Dependencies:	The Status Operation Register bit 5 "Waiting for Trigger" is set at the same time as the Sweeping or Measuring bit is set. It is cleared when the trigger actually occurs (that is, after the trigger event occurs and all the applicable trigger criteria have been met). A corresponding pop-up message ("Waiting for trigger") is generated if no trigger signal appears after approximately 2 sec. This message goes away when a trigger signal appears.
Instrument S/W Revision:	Prior to A.02.00

Video (IF Envelope)

Pressing this key, when it is not selected, selects the video signal as the trigger. The Video trigger condition is met when the video signal (the filtered and detected version of the input signal, including both RBW and VBW filtering) crosses the video trigger level.

NOTE When the detector selected for all active traces is the average detector, the video signal for triggering does not include any VBW filtering.

The video trigger level is shown as a labeled line on the display. The line is displayed as long as video is the selected trigger source.

Pressing this key, when it is already selected, accesses the video trigger setup functions.

Example:	TRIG:SOUR VID Swept SA measurement TRIG:<meas>:SOUR VID Measurements other than Swept SA
Dependencies/Couplings:	Video trigger is allowed in average detector mode.
State Saved:	Saved in instrument state.
Key Path:	Trigger
Notes:	Log Plot and Spot Frequency measurements do not support Video Trigger
SCPI Status Bits/OPC Dependencies:	The Status Operation Register bit 5 "Waiting for Trigger" is set at the same time as the Sweeping or Measuring bit is set. It is cleared when the trigger actually occurs (that is, after the trigger event occurs and all the applicable trigger criteria have been met). A corresponding pop-up message ("Waiting for trigger") is generated if no trigger signal appears after approximately 2 sec. This message goes away when a trigger signal appears.
Instrument S/W Revision:	Prior to A.02.00

Trigger

Trigger Level

Sets a level for the video signal trigger. When the video signal crosses this level, with the chosen slope, the trigger occurs. This level is displayed with a horizontal line only if **Video** is the selected trigger source.

Remote Command:	:TRIGger[:SEQuence]:VIDeo:LEVel <ampl> :TRIGger[:SEQuence]:VIDeo:LEVel?
Example:	TRIG:VID:LEV -40 dBm
Dependencies/Couplings:	This same level is used for the Video trigger source in the Trigger menu and for the Video selection in the Gate Source menu. The range of the Video Trigger Level is dependent on the Reference Level.
Preset:	Set the Video Trigger Level -25 dBm on Preset. When the Video Trigger Level becomes the active function, if the value is off screen, set it to either the top or bottom of screen, depending on which direction off screen it was.
State Saved:	Saved in instrument state.
Min:	Same as reference level
Max:	Same as reference level
Key Path:	Trigger, Video
Default Unit:	depends on the current selected Y axis unit
Instrument S/W Revision:	Prior to A.02.00

Trig Slope

Controls the trigger polarity. It is set positive to trigger on a rising edge and negative to trigger on a falling edge.

Remote Command:	:TRIGger[:SEQuence]:VIDeo:SLOPe POSitive NEGative :TRIGger[:SEQuence]:VIDeo:SLOPe?
Example:	TRIG:VID:SLOP NEG
Preset:	POSitive
State Saved:	Saved in instrument state.
Key Path:	Trigger, Video
Instrument S/W Revision:	Prior to A.02.00

Trig Delay

Controls a time delay during which the analyzer will wait to begin a sweep after meeting the trigger criteria. You can use negative delay to pre-trigger the instrument in time domain or FFT, but not in swept spans.

Remote Command: :TRIGger [:SEQuence] :VIDeo:DELAy <time>
 :TRIGger [:SEQuence] :VIDeo:DELAy?
 :TRIGger [:SEQuence] :VIDeo:DELAy:STATe OFF|ON|0|1
 :TRIGger [:SEQuence] :VIDeo:DELAy:STATe?

Example: TRIG:VID:DEL:STAT ON
 TRIG:VID:DEL 100 ms

Preset: Off, 1 us

State Saved: Saved in instrument state.

Min: -150 ms

Max: +500 ms

Key Path: **Trigger, Video**

Default Unit: s

Instrument S/W Revision: Prior to A.02.00

Line

Pressing this key, when it is not selected, selects the line signal as the trigger. A new sweep/measurement will start synchronized with the next cycle of the line voltage. Pressing this key, when it is already selected, access the line trigger setup menu.

Example: TRIG:SOUR LINE Swept SA measurement
 TRIG:<meas>:SOUR LINE Measurements other than Swept SA

Dependencies/Couplings: Line trigger is not available when operating from a "dc power source", for example, when the instrument is powered from batteries.

State Saved: Saved in instrument state.

Key Path: **Trigger**

SCPI Status Bits/OPC Dependencies: The Status Operation Register bit 5 "Waiting for Trigger" is set at the same time as the Sweeping or Measuring bit is set. It is cleared when the trigger actually occurs (that is, after the trigger event occurs and all the applicable trigger criteria have been met). A corresponding pop-up message ("Waiting for trigger") is generated if no trigger signal appears after approximately 2 sec. This message goes away when a trigger signal appears.

Instrument S/W Revision: Prior to A.02.00

Trigger

Trig Slope

Controls the trigger polarity. It is set positive to trigger on a rising edge and negative to trigger on a falling edge.

Remote Command:	<code>:TRIGger[:SEQuence]:LINE:SLOPe POSitive NEGative</code> <code>:TRIGger[:SEQuence]:LINE:SLOPe?</code>
Example:	<code>TRIG:LINE:SLOP NEG</code>
Preset:	POSitive
State Saved:	Saved in instrument state.
Key Path:	Trigger, Line
Instrument S/W Revision:	Prior to A.02.00

Trig Delay

Controls a time delay during which the analyzer will wait to begin a sweep after meeting the trigger criteria. You can use negative delay to pre-trigger the instrument in time domain or FFT, but not in swept spans.

Remote Command:	<code>:TRIGger[:SEQuence]:LINE:DELay <time></code> <code>:TRIGger[:SEQuence]:LINE:DELay?</code> <code>:TRIGger[:SEQuence]:LINE:DELay:STATe OFF ON 0 1</code> <code>:TRIGger[:SEQuence]:LINE:DELay:STATe?</code>
Example:	<code>TRIG:LINE:DEL:STAT ON</code> <code>TRIG:LINE:DEL 100 ms</code>
Preset:	Off, 1.000 us
State Saved:	Saved in instrument state.
Min:	-150 ms
Max:	500 ms
Key Path:	Trigger, Line
Default Unit:	S
Instrument S/W Revision:	Prior to A.02.00

External 1

Pressing this key, when it is not selected, selects an external input signal as the trigger. A new sweep/measurement will start when the external trigger condition is met using the external 1 input connector on the rear panel.

Pressing this key, when it is already selected, accesses the external 1 trigger setup menu.

Example:	TRIG:SOUR EXT1 Swept SA measurement TRIG:<meas>:SOUR EXT1 Measurements other than Swept SA
State Saved:	Saved in instrument state.
Key Path:	Trigger
SCPI Status Bits/OPC Dependencies:	The Status Operation Register bit 5 "Waiting for Trigger" is set at the same time as the Sweeping or Measuring bit is set. It is cleared when the trigger actually occurs (that is, after the trigger event occurs and all the applicable trigger criteria have been met). A corresponding pop-up message ("Waiting for trigger") is generated if no trigger signal appears after approximately 2 sec. This message goes away when a trigger signal appears.
Instrument S/W Revision:	Prior to A.02.00

Trigger Level

Sets the value where the external 1 trigger input will trigger a new sweep/measurement.

Remote Command:	:TRIGger[:SEquence]:EXTernal1:LEVel <level> :TRIGger[:SEquence]:EXTernal1:LEVel?
Example:	TRIG:EXT1:LEV 0.4 V
Dependencies/Couplings:	This same level is used for the Ext1 trigger source in the Trigger menu, for the Ext1 selection in the Periodic Timer sync source (in the Trigger menu and in the Gate Source menu), and also for the Ext1 selection in the Gate Source menu.
Preset:	1.2 V
State Saved:	Saved in instrument state.
Min:	-5 V
Max:	5 V
Key Path:	Trigger, External 1
Default Unit:	V
Instrument S/W Revision:	Prior to A.02.00

Trig Slope

Controls the trigger polarity. It is set positive to trigger on a rising edge and negative to trigger on a falling edge.

Remote Command:	:TRIGger[:SEquence]:EXTernal1:SLOPe POSitive NEGative :TRIGger[:SEquence]:EXTernal1:SLOPe?
Example:	TRIG:EXT1:SLOP NEG

Trigger

Dependencies/Couplings:	This same slope is used in the Ext1 selection for the trigger source in the Trigger menu and for the period timer sync source (in the Trigger menu and in the Gate Source menu).
Preset:	POSitive
State Saved:	Saved in instrument state.
Key Path:	Trigger, External 1
Instrument S/W Revision:	Prior to A.02.00

Trig Delay

Controls a time delay during which the analyzer will wait to begin a sweep after meeting the trigger criteria. You can use negative delay to pre-trigger the instrument in time domain or FFT, but not in swept spans.

Remote Command:	<code>:TRIGger[:SEquence]:EXTernal1:DELay <time></code> <code>:TRIGger[:SEquence]:EXTernal1:DELay?</code> <code>:TRIGger[:SEquence]:EXTernal1:DELay:STATe OFF ON 0 1</code> <code>:TRIGger[:SEquence]:EXTernal1:DELay:STATe?</code>
------------------------	--

Example: `TRIG:EXT1:DEL:STAT ON`
`TRIG:EXT1:DEL 100 ms`

Preset:	Off, 1.000 us
State Saved:	Saved in instrument state.
Min:	-150 ms
Max:	+500 ms
Key Path:	Trigger, External 1
Default Unit:	s
Instrument S/W Revision:	Prior to A.02.00

External 2

Pressing this key, when it is not selected, selects an external input signal as the trigger. A new sweep/measurement will start when the external trigger condition is met using the external 2 input connector. The external trigger 2 input connector is on the rear panel.

Pressing this key, when it is already selected, accesses the external 2 trigger setup menu.

Example:	<code>TRIG:SOUR EXT2</code> Swept SA measurement <code>TRIG:<meas>:SOUR EXT2</code> Measurements other than Swept SA
State Saved:	Saved in instrument state.

Key Path:	Trigger
SCPI Status Bits/OPC Dependencies:	The Status Operation Register bit 5 "Waiting for Trigger" is set at the same time as the Sweeping or Measuring bit is set. It is cleared when the trigger actually occurs (that is, after the trigger event occurs and all the applicable trigger criteria have been met). A corresponding pop-up message ("Waiting for trigger") is generated if no trigger signal appears after approximately 2 sec. This message goes away when a trigger signal appears.
Instrument S/W Revision:	Prior to A.02.00

Trigger Level

Sets the value where the external 2 trigger input will trigger a new sweep/measurement.

Remote Command:	:TRIGger[:SEquence]:EXTernal2:LEVel :TRIGger[:SEquence]:EXTernal2:LEVel?
Example:	TRIG:EXT2:LEV 1.1 V
Dependencies/Couplings:	This same level is used for the Ext2 trigger source in the Trigger menu, for the Ext2 selection in the Periodic Timer sync source (in the Trigger menu and in the Gate Source menu), and also for the Ext2 selection in the Gate Source menu.
Preset:	1.2 V
State Saved:	Saved in instrument state.
Min:	-5 V
Max:	5 V
Key Path:	Trigger, External 2
Default Unit:	V
Instrument S/W Revision:	Prior to A.02.00

Trig Slope

Controls the trigger polarity. It is set positive to trigger on a rising edge and negative to trigger on a falling edge.

Remote Command:	:TRIGger[:SEquence]:EXTernal2:SLOPe POSitive NEGative :TRIGger[:SEquence]:EXTernal2:SLOPe?
Example:	TRIG:EXT2:SLOP NEG
Dependencies/Couplings:	This same slope is used in the Ext2 selection for the trigger source in the Trigger menu and for the period timer sync source (in the Trigger menu and in the Gate Source menu).
Preset:	POSitive

Trigger

State Saved: Saved in instrument state.
Key Path: **Trigger, External 2**
Instrument S/W Revision: Prior to A.02.00

Trig Delay

Controls a time delay during which the analyzer will wait to begin a sweep after meeting the trigger criteria. You can use negative delay to pre-trigger the instrument in time domain or FFT, but not in swept spans.

Remote Command: :TRIGger[:SEquence]:EXTErnal2:DElAY <time>
:TRIGger[:SEquence]:EXTErnal2:DElAY?
:TRIGger[:SEquence]:EXTErnal2:DElAY:STATe OFF|ON|0|1
:TRIGger[:SEquence]:EXTErnal2:DElAY:STATe?

Example: TRIG:EXT2:DEL:STAT ON
TRIG:EXT2:DEL 100 ms

Preset: Off, 1.000 us
State Saved: Saved in instrument state.
Min: -150 ms
Max: 500 ms
Key Path: **Trigger, External 2**
Default Unit: s
Instrument S/W Revision: Prior to A.02.00

RF Burst (Wideband)

Pressing this key, when it is not selected, selects the RF Burst as the trigger. A new sweep/measurement will start when an RF burst envelope signal is identified from the signal at the RF Input connector. Pressing this key, when it is already selected, accesses the RF Burst trigger setup menu.

Example: TRIG:SOUR RFB Swept SA measurement
TRIG:<meas>:SOUR RFB Measurements other than Swept SA
Key Path: **Trigger**
State Saved: Saved in instrument state.

SCPI Status Bits/OPC Dependencies:	The Status Operation Register bit 5 "Waiting for Trigger" is set at the same time as the Sweeping or Measuring bit is set. It is cleared when the trigger actually occurs (that is, after the trigger event occurs and all the applicable trigger criteria have been met). A corresponding pop-up message ("Waiting for trigger") is generated if no trigger signal appears after approximately 2 sec. This message goes away when a trigger signal appears.
Instrument S/W Revision:	Prior to A.02.00

Trigger Level

Sets the trigger level for the RF burst envelope.

In some measurements, both absolute and relative burst trigger functions are available. When Relative is available, this key will display a toggle between **Abs** and **Rel** on the third line. When **Abs** is selected, the value on the key is the absolute trigger level; when **Rel** is selected, the value is the relative trigger level.

If no toggle appears on the key, the measurement only supports absolute trigger level.

The relative RF Burst trigger is implemented as follows:

The measurement starts with the absolute RF Burst trigger setting. If it can not get a trigger with that level, auto trigger fires and the acquisition starts anyway. After the acquisition, the measurement searches for the peak in the acquired waveform and saves it.

Now, in the next cycle of the measurement, the measurement determines a new absolute RF Burst level based on the peak value from the first measurement and the Relative RF Burst Trigger Level (always 0 or negative dB) set by you. The following formula is used:

absolute RF Burst level = peak level of the previous acquisition + relative RF Burst level

If the new absolute RF Burst level differs from the previous by more than 0.5 dB, the new level is sent to the hardware; otherwise it is not updated (to avoid slowing down the acquisition)

Steps 2 and 3 repeat for subsequent measurements.

Remote Command:

```
:TRIGger[:SEquence]:RFBurst:LEVel:ABSolute <ampl>
:TRIGger[:SEquence]:RFBurst:LEVel:RELative <ampl>
:TRIGger[:SEquence]:RFBurst:LEVel:ABSolute?
:TRIGger[:SEquence]:RFBurst:LEVel:RELative?
:TRIGger[:SEquence]:RFBurst:LEVel:TYPE
ABSolute|RELative
:TRIGger[:SEquence]:RFBurst:LEVel:TYPE?
```

Example: TRIG:RFB:LEV:ABS 10 dBm sets the trigger level of the RF burst envelope signal to the absolute level of 10 dBm.

Dependencies/Couplings: This same level is used for the RF Burst trigger source in the Trigger menu, for the RF Burst selection in the Periodic Timer sync source (in the Trigger menu and in the Gate Source menu), and also for the RF Burst selection in the Gate Source menu.

Trigger

Preset:	Absolute: -20 dBm Relative: -6 dB GSM: -25 dB ABSolute
State Saved:	Saved in instrument state.
Min:	Absolute: -200 dBm Relative: -45 dB
Max:	Absolute: 100 dBm Relative: 0 dB
Key Path:	Trigger, RF Burst
Default Unit:	Absolute: depends on the current selected Y-Axis unit Relative: dB or dBc
Instrument S/W Revision:	Prior to A.02.00

Trigger Slope

It is set positive to trigger on a rising edge and negative to trigger on a falling edge.

Remote Command:	:TRIGger[:SEQuence]:RFBurst:SLOPe POSitive NEGative :TRIGger[:SEQuence]:RFBurst:SLOPe?
Example:	TRIG:RFB:SLOP NEG
Dependencies/Couplings:	This same slope is used in the RF Burst selection for the trigger source in the Trigger menu and for the period timer sync source (in the Trigger menu and in the Gate Source menu).
Preset:	POSitive
State Saved:	Saved in instrument state.
Key Path:	Trigger, RF Burst
Instrument S/W Revision:	Prior to A.02.00

Trig Delay

Controls a time delay during which the analyzer will wait to begin a sweep after meeting the trigger criteria. You can use negative delay to pre-trigger the instrument in time domain or FFT, but not in swept spans.

Remote Command: :TRIGger[:SEQuence]:RFBurst:DELay <time>
 :TRIGger[:SEQuence]:RFBurst:DELay?
 :TRIGger[:SEQuence]:RFBurst:DELay:STATe OFF|ON|0|1
 :TRIGger[:SEQuence]:RFBurst:DELay:STATe?

Example: TRIG:RFB:DEL:STAT ON
 TRIG:RFB:DEL 100 ms

Preset: Off, 1.000 us
 State Saved: Saved in instrument state.
 Min: -150 ms
 Max: 500 ms
 Key Path: **Trigger, RF Burst**
 Default Unit: s
 Instrument S/W Revision: Prior to A.02.00

Periodic Timer (Frame Trigger)

Pressing this key, when it is not selected, selects the internal periodic timer signal as the trigger. Triggering occurrences are set by the **Period** parameter, which is modified by the **Sync Source** and **Offset**. Pressing this key, when it is already selected, accesses the periodic timer trigger setup functions.

If you do not have a sync source selected (it is Off), then the internal timer will not be synchronized with any external timing events.

Example: TRIG:SOUR FRAM Swept SA measurement
 TRIG:<meas>:SOUR FRAM Measurements other than Swept SA

State Saved: Saved in instrument state.

Key Path: **Trigger**

Readback: [Sync: <value of Sync Source>], for example, [Sync: External 1]

SCPI Status Bits/OPC
 Dependencies: The Status Operation Register bit 5 "Waiting for Trigger" is set at the same time as the Sweeping or Measuring bit is set. It is cleared when the trigger actually occurs (that is, after the trigger event occurs and all the applicable trigger criteria have been met). A corresponding pop-up message ("Waiting for trigger") is generated if no trigger signal appears after approximately 2 sec. This message goes away when a trigger signal appears.

Trigger

Instrument S/W Revision: Prior to A.02.00

Periodic Timer Triggering:

This feature selects the internal periodic timer signal as the trigger. Trigger occurrences are set by the **Periodic Timer** parameter, which is modified by the **Sync Source** and **Offset**.

The figure below shows the action of the periodic timer trigger. Before reviewing the figure, we'll explain some uses for the periodic trigger.

A common application is measuring periodic burst RF signals for which a trigger signal is not easily available. For example, we might be measuring a TDMA radio which bursts every 20 ms. Let's assume that the 20 ms period is very consistent. Let's also assume that we do not have an external trigger source available that is synchronized with the period, and that the signal-to-noise ratio of the signal is not high enough to provide a clean RF burst trigger at all of the analysis frequencies. For example, we might want to measure spurious transmissions at an offset from the carrier that is larger than the bandwidth of the RF burst trigger. In this application, we can set the Periodic Timer to a 20.00 ms period and adjust the offset from that timer to position our trigger just where we want it. If we find that the 20.00 ms is not exactly right, we can adjust the period slightly to minimize the drift between the period timer and the signal to be measured.

A second way to use this feature would be to use **Sync Source** temporarily, instead of **Offset**. In this case, we might tune to the signal in a narrow span and use the RF Burst trigger to synchronize the periodic timer. Then we would turn the sync source off so that it would not mis-trigger. Mis-triggering can occur when we are tuned so far away from the RF burst trigger that it is no longer reliable.

A third example would be to synchronize to a signal that has a reference time element of much longer period than the period of interest. In some CDMA applications, it is useful to look at signals with a short periodicity, by synchronizing that periodicity to the "even-second clock" edge that happens every two seconds. Thus, we could connect the even-second clock trigger to Ext1 and use then Ext1 as the sync source for the periodic timer.

The figure below illustrates this third example. The top trace represents the even-second clock. It causes the periodic timer to synchronize with the leading edge shown. The analyzer trigger occurs at a time delayed by the accumulated offset from the period trigger event. The periodic timer continues to run, and triggers continue to occur, with a periodicity determined by the analyzer time base. The timer output (labeled "late event") will drift away from its ideal time due to imperfect matching between the time base of the signal being measured and the time base of the analyzer, and also because of imperfect setting of the period parameter. But the synchronization is restored on the next even-second clock event. ("Accumulated offset" is described in the in the **Offset** function section.)

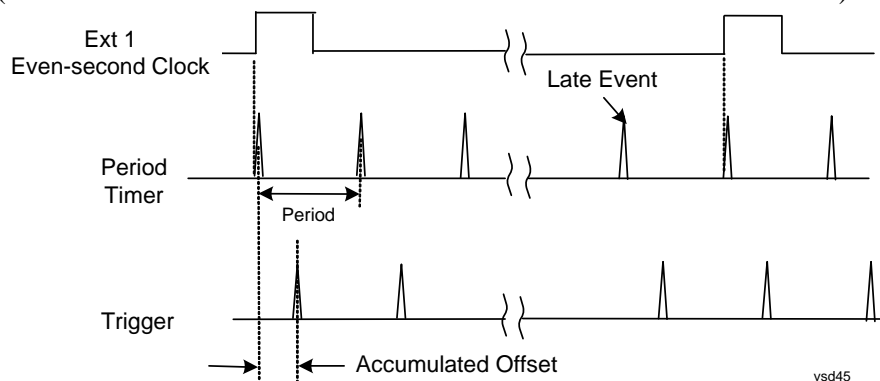

Period

Sets the period of the internal periodic timer clock. For digital communications signals, this is usually set to the frame period of your current input signal. In the case that sync source is not set to OFF, and the external sync source rate is changed for some reason, the periodic timer is synchronized at the every external synchronization pulse by resetting the internal state of the timer circuit.

Remote Command:	:TRIGger [:SEQuence] :FRAMe:PERiod <time> :TRIGger [:SEQuence] :FRAMe:PERiod?
Example:	TRIG:FRAM:PER 100 ms
Dependencies/Couplings:	The invalid data indicator turns on when the period is changed, until the next sweep/measurement completes. The same period is used in the Gate Source selection of the period timer.
Preset:	20 ms GSM: 4.615383
State Saved:	Saved in instrument state.
Min:	100.000 ns
Max:	559.0000 ms
Key Path:	Trigger, Periodic Timer
Default Unit:	S
Instrument S/W Revision:	Prior to A.02.00

Offset

Adjusts the accumulated offset between the periodic timer events and the trigger event. Adjusting the accumulated offset is different than setting an offset, and requires explanation.

The periodic timer is usually not synchronized with any external events, so the timing of its output events has no absolute meaning. Since the timing relative to external events (RF signals) is important, you need to be able to adjust (offset) it. However, you have no direct way to see when the periodic timer events occur. All that you can see is the trigger timing. When you want to adjust the trigger timing, you will be changing the internal offset between the periodic timer events and the trigger event. Because the absolute value of that internal offset is unknown, we will just call that the accumulated offset. Whenever the Offset parameter is changed, you are changing that accumulated offset. You can reset the displayed offset using Reset Offset Display. Changing the display does not change the value of the accumulated offset, and you can still make additional changes to accumulated offset.

To avoid ambiguity, we define that an increase in the "offset" parameter, either from the knob or the SCPI adjust command, serves to delay the timing of the trigger event.

Remote Command:	:TRIGger [:SEQuence] :FRAMe:OFFSet <time> :TRIGger [:SEQuence] :FRAMe:OFFSet?
Example:	TRIG:FRAM:OFFS 1.2 ms

Trigger

Dependencies/Couplings:	The invalid data indicator turns on when the offset is changed, until the next sweep/measurement completes. The same offset is used in the Gate Source selection of the period timer.
Remote Command Notes:	When the SCPI command is sent the value shown on the key (and the Active Function, if this happens to be the active function) is updated with the new value. However, the actual amount sent to the hardware is the delta value, that is, the current accumulated offset value minus the previous accumulated offset value. The SCPI query simply returns the value currently showing on the key.
Preset:	0 s
State Saved:	Saved in instrument state.
Min:	-10.000 s
Max:	10.000 s
Key Path:	Trigger, Periodic Timer
Default Unit:	S
Instrument S/W Revision:	Prior to A.02.00

Offset Adjust (Remote Command only)

This remote command does not work at all like the related front-panel keys. This command lets you advance the phase of the frame trigger by the amount you specify.

It does not change the period of the trigger waveform. If the command is sent multiple times, it advances the phase of the frame trigger an additional amount each time it is sent. Negative numbers are permitted.

Remote Command:	:TRIGger [:SEQuence] :FRAMe:ADJust <time>
Example:	TRIG:FRAM:ADJ 1.2 ms
Dependencies/Couplings:	The invalid data indicator turns on when the offset is changed, until the next sweep/measurement completes. The same offset is used in the Gate Source selection of the period timer.
Remote Command Notes:	The front panel interface (for example, the knob) and the :TRIG:FRAM:OFFS command adjust the accumulated offset, which is shown on the active function display. However, the actual amount sent to the hardware is the delta value, that is, the current offset value minus the previous offset value. When the SCPI command is sent the value shown on the key (and the Active Function, if this happens to be the active function) is updated by increasing it (or decreasing it if the value sent is negative) by the amount specified in the SCPI command. This is a "command only" SCPI command, with no query.
Preset:	0 s
State Saved:	Saved in instrument state.

Min:	-10.000 s
Max:	10.000 s
Default Unit:	S
Instrument S/W Revision:	Prior to A.02.00

Reset Offset Display

Resets the value of the periodic trigger offset display setting to 0.0 seconds. The current displayed trigger location may include an offset value defined with the **Offset** key. Pressing this key redefines the currently displayed trigger location as the new trigger point that is 0.0 s offset. The **Offset** key can then be used to add offset relative to this new timing.

Remote Command:	:TRIGger[:SEQuence]:FRAMe:OFFSet:DISPlay:RESet
Example:	TRIG:FRAM:OFFS:DISP:RES
Key Path:	Trigger, Periodic Timer
Instrument S/W Revision:	Prior to A.02.00

Sync Source

Selects a signal source for you to synchronize your periodic timer trigger to, otherwise you are triggering at some arbitrary location in the frame. Synchronization reduces the precision requirements on the setting of the period.

For convenience you may adjust the level and slope of the selected sync source in a conditional branch setup menu accessed from the Sync Source menu. Note that these settings match those in the **Trigger** and **Gate Source** menus; that is, each trigger source has only one value of level and slope, regardless of which menu it is accessed from.

Remote Command:	:TRIGger[:SEQuence]:FRAMe:SYNC EXTernal1 EXTernal2 RFBurst OFF :TRIGger[:SEQuence]:FRAMe:SYNC?
Example:	TRIG:FRAM:SYNC EXT2
Preset:	Off GSM/EDGE: RFBurst
State Saved:	Saved in instrument state.
Key Path:	Trigger, Periodic Timer
Readback:	The current setting is read back to this key and it is also Readback to the previous Periodic Timer trigger key.
Instrument S/W Revision:	Prior to A.02.00

Trigger

Off

Turns off the sync source for your periodic trigger. With the sync source off, the timing will drift unless the signal source frequency is locked to the analyzer frequency reference.

Example:	TRIG:FRAM:SYNC OFF
Key Path:	Trigger, Periodic Timer, Sync Source
Readback:	Off
Instrument S/W Revision:	Prior to A.02.00

External 1

Pressing this key, when it is not selected, selects the external input port that you will use for the periodic trigger synchronization. Pressing this key, when it is already selected, accesses the external 1 sync source setup menu.

Example:	TRIG:FRAM:SYNC EXT
Dependencies/Couplings:	Same as External 1 trigger source.
Key Path:	Trigger, Periodic Timer, Sync Source
Readback:	External 1
Instrument S/W Revision:	Prior to A.02.00

External 2

Pressing this key, when it is not selected, selects the external input port that you will use for the periodic frame trigger synchronization.

Pressing this key, when it is already selected, accesses the external 2 sync source setup menu.

Example:	TRIG:FRAM:SYNC EXT2
Dependencies/Couplings:	Same as External 2 trigger source.
Key Path:	Trigger, Periodic Timer, Sync Source
Readback:	External 2
Instrument S/W Revision:	Prior to A.02.00

RF Burst (Wideband)

Pressing the key once selects the RF burst envelope signal to be used for the periodic timer trigger synchronization.

Press the key a second time to access the RF burst sync source setup menu.

Example:	TRIG:FRAM:SYNC RFB
Dependencies/Couplings:	Same as RF Burst trigger source.

Key Path: **Trigger, Periodic Timer, Sync Source**
 Readback: RF Burst
 Instrument S/W Revision: Prior to A.02.00

Trig Delay

This setting delays the measurement timing relative to the Periodic Timer.

Remote Command: :TRIGger[:SEQuence]:FRAMe:DELay <time>
 :TRIGger[:SEQuence]:FRAMe:DELay?
 :TRIGger[:SEQuence]:FRAMe:DELay:STATe OFF|ON|0|1
 :TRIGger[:SEQuence]:FRAMe:DELay:STATe?

Preset: Off, 1.000 us
 State Saved: Saved in instrument state.
 Min: -150 ms
 Max: +500 ms
 Key Path: **Trigger, Periodic Timer**
 Default Unit: s
 Instrument S/W Revision: Prior to A.02.00

Sync Holdoff

Sync Holdoff specifies the duration that the sync source signal must be kept false before the transition to true to be recognized as the sync timing. The periodic timer phase is aligned when the sync source signal becomes true, after the Holdoff time is satisfied.

A holdoff of 2 ms will work with most WiMAX signals, but there may be cases where the burst off duration is less than 1 ms and this value will need to be changed.

Remote Command: :TRIGger[:SEQuence]:FRAMe:SYNC:HOLDoff <time>
 :TRIGger[:SEQuence]:FRAMe:SYNC:HOLDoff?
 :TRIGger[:SEQuence]:FRAMe:SYNC:HOLDoff:STATe OFF|ON|0|1
 :TRIGger[:SEQuence]:FRAMe:SYNC:HOLDoff:STATe?

Preset: On, 1.000 ms
 State Saved: Saved in instrument state.
 Min: 0 ms
 Max: +500 ms
 Key Path: **Trigger, Periodic Timer**
 Default Unit: s

Trigger

Instrument S/W Revision: Prior to A.02.00

LXI Trigger

Pressing this key when it is not selected selects the LXI system as the trigger. Pressing the key when it is already selected accesses the LXI trigger type selection menu, where either LAN Event or Alarm can be chosen. The key is annotated to display which of the two is currently selected.

NOTE For information about setting up measurements using LXI, refer to the Programmer's Guide located in your analyzer at: C:/Program Files/Agilent/Signal Analysis/Help/Bookfiles/x_series_prog.pdf. It is also available by selecting the "Additional Documentation" page of the Help.

Key Path	Trigger
Mode	SA, IQ(Basic)
Preset	ON
State Saved	Saved in instrument state.
Readback	The LXI trigger source that becomes active when this key is selected is displayed. The possible values are "LAN Event" and "Alarm"
Instrument S/W Revision	Prior to A.02.00

LAN Event

Pressing this key when it is not selected selects the LAN event system as the LXI trigger. A new sweep/measurement starts when the pre-configured LAN message arrives if the LXI trigger is selected (see "[LXI Trigger](#)" on page 666). Pressing this key when it is already selected accesses the LAN trigger setup menu.

NOTE Pressing this button causes Enabled LXI Alarm Triggers to be ignored, since the Trigger source is changed to LXI LAN Event.

Example	TRIG:SOUR LAN Swept SA measurement TRIG:<meas>:SOUR LAN Measurements other than Swept SA
SCPI Status Bits/OPC Dependencies	The Status Operation Register bit 5 "Waiting for Trigger" is set at the same time as the Sweeping or Measuring bit is set. It is cleared when the trigger actually occurs (that is, after the trigger event occurs and all the applicable trigger criteria have been met). A corresponding pop-up message ("Waiting for trigger") is generated if no trigger signal appears after approximately 2 sec. This message goes away when a trigger signal appears.
Key Path	Trigger, LXI Trigger
Mode	SA, IQ(Basic)

Preset	ON
State Saved	Saved in instrument state.
State Saved	Saved in instrument state.
Instrument S/W Revision	Prior to A.02.00

Disable All

Sets the Enable parameter of every member of the LXI LAN Event list to OFF.

Remote Command	:TRIGger[:SEquence]:LXI:LAN:DISable:ALL
Example	:TRIG:LXI:LAN:DIS:ALL
Key Path	Trigger LXI Trigger, LAN Event
Mode	SA, IQ(Basic)
Instrument S/W Revision	Prior to A.02.00

LAN Event List

After selecting LAN as the trigger source, you are presented with a list of LXI Trigger LAN Events to be configured. By default, LAN0-LAN7 are available. Using the TRIG:LXI:LAN:ADD and TRIG:LXI:LAN:REM commands, the size of this list can be changed arbitrarily. Pressing a LAN event branches to that event's setup menu.

Remote Command	:TRIGger[:SEquence]:LXI:LAN:LIST?
Example	:TRIG:LXI:LAN:LIST? Returns the complete list of Trigger LAN Events which is, at minimum: "LAN0", "LAN1", "LAN2", "LAN3", "LAN4", "LAN5", "LAN6", "LAN7"
Key Path	Trigger LXI Trigger, LAN Event
Mode	SA, IQ(Basic)
Preset	"LAN0", "LAN1", "LAN2", "LAN3", "LAN4", "LAN5", "LAN6", "LAN7"
State Saved	Saved in instrument state.
Readback	Displays the value of the LXI Trigger LAN Event parameter (Enabled Disabled).
Instrument S/W Revision	Prior to A.02.00

Detection

Pressing this button brings up the Trigger Detection menu.

Selecting "Rise" causes the instrument to trigger on the receipt of a signal low LAN Event followed by a signal high LAN Event.

Selecting "Fall" caused the instrument to trigger on the receipt of a signal high LAN Event followed by a signal low LAN Event.

Trigger

Selecting "High" causes the instrument to trigger on every signal high LAN Event.

Selecting "Low" causes the instrument to trigger on every signal low LAN Event.

Remote Command	:TRIGger[:SEQuence]:LXI:LAN[:SET]:DETEction "LANEVENT", HIGH LOW RISE FALL
Example	:TRIG:LXI:LAN:DET "LAN0",HIGH
Restriction and Notes	If a non existent LAN event is passed in the lanEvent argument, the command is ignored
Key Path	Trigger LXI Trigger, LAN Event, <lanEvent>
Mode	SA, IQ(Basic)
Preset	HIGH
State Saved	Saved in instrument state.
Range	HIGH LOW RISE FALL
Readback	Currently selected detection type
Instrument S/W Revision	Prior to A.02.00

Remote Command	:TRIGger[:SEQuence]:LXI:LAN[:SET]:DETEction? "LANEVENT"
Example	:TRIG:LXI:LAN:DET? "LAN0"?
Restriction and Notes	If a non existent LAN event is passed in the lanEvent argument, the command is ignored
Key Path	Trigger LXI Trigger, LAN Event, <lanEvent>
Mode	SA, IQ(Basic)
Preset	HIGH
State Saved	Saved in instrument state.
Range	HIGH LOW RISE FALL
Readback	Currently selected detection type
Instrument S/W Revision	Prior to A.02.00

Delay

Sets the amount of delay that should pass between receiving a LXI Trigger LAN Event Trigger and the trigger action. A Delay of 0.0 s indicates that the instrument will trigger as soon as possible after receiving the proper LXI LAN Event.

Remote Command	:TRIGger[:SEQuence]:LXI:LAN[:SET]:DELaY "LANEVENT",<time>
Example	:TRIG:LXI:LAN:DEL "LAN0",5S
Key Path	Trigger, LXI Trigger, LAN Event, <lanEvent>

Mode	SA, IQ(Basic)
Preset	0.0 s
State Saved	Saved in instrument state.
Range	0.0 – 1.7976931348623157 x 10308 (Max Double)
Instrument S/W Revision	Prior to A.02.00

Remote Command :TRIGger [:SEquence] :LXI:LAN[:SET]:DELay? "lanEvent"

Example :TRIG:LXI:LAN:DEL? "LAN0"

Key Path **Trigger, LXI Trigger, LAN Event, <lanEvent>**

Mode	SA, IQ(Basic)
Preset	0.0 s
State Saved	Saved in instrument state.
Range	0.0 – 1.7976931348623157 x 10308 (Max Double)
Instrument S/W Revision	Prior to A.02.00

Enabled/Disabled

When the Trigger Source is set to LXI Trigger LAN Event, the instrument triggers upon receiving any event from the LXI Trigger LAN Event List whose Enabled parameter is set to ON.

If the Enabled parameter is set to OFF, the event is ignored.

Remote Command :TRIGger [:SEquence] :LXI:LAN[:SET]:ENABled "LANEVENT", ON|OFF|1|0

Example :TRIG:LXI:LAN:ENAB "LAN0",ON

Key Path **Trigger, LXI Trigger, LAN Event, <lanEvent>**

Mode	SA, IQ(Basic)
Preset	OFF
State Saved	Saved in instrument state.
Range	OFF ON 0 1
Instrument S/W Revision	Prior to A.02.00

Remote Command :TRIGger [:SEquence] :LXI:LAN[:SET]:ENABled? "LANEVENT"

Example :TRIG:LXI:LAN:ENAB? "LAN0"

Key Path **Trigger, LXI Trigger, LAN Event, <lanEvent>**

Mode	SA, IQ(Basic)
Preset	OFF

Trigger

State Saved	Saved in instrument state.
Range	OFF ON 0 1
Instrument S/W Revision	Prior to A.02.00

Add (Remote Command Only)

Adds the provided string to the list of possible LAN events to trigger on. As new LAN events are added, keys are generated in the LAN source menu. New key panels are generated as the number of possible LAN events increases past a multiple of six, and the "More" keys are updated to reflect the new number of key panels in the LAN source menu.

Remote Command	:TRIGger [:SEquence] :LXI :LAN :ADD "LANEVENT"
Example	:TRIG:LXI:LAN:ADD "LANEVENT"
Restriction and Notes	The maximum length of the string is 16 characters. Longer strings are concatenated to 16 characters and added. No event is added if the LAN Event already exists. This command modifies the LXI Trigger LAN Event List Parameter.
Mode	SA, IQ(Basic)
State Saved	No
Range	Uppercase, Lowercase, Numeric, Symbol except for comma or semicolon
Instrument S/W Revision	Prior to A.02.00

Remove (Remote Command Only)

Removes the provided string from the list of possible LAN events to trigger on. As LAN events are removed, keys are removed from the LAN source menu. Key panels are removed as the number of possible LAN events decreases past a multiple of six, and the "More" keys are updated to reflect the new number of key panels in the LAN source menu. It is not possible to remove the "LAN0" – "LAN7" events.

Remote Command	:TRIGger [:SEquence] :LXI :LAN :REMOve [:EVENT] "LANEVENT"
Example	:TRIG:LXI:LAN:REM "LANEVENT"
Restriction and Notes	The maximum length of the string is 16 characters. Longer strings are concatenated and the corresponding LAN Event is removed. Nothing happens if the LAN event does not exist. This command modifies the LXI Trigger LAN Event List Parameter.
Mode	SA, IQ(Basic)
State Saved	No

Range	Uppercase, Lowercase, Numeric, Symbol except for comma or semicolon
Instrument S/W Revision	Prior to A.02.00

Remove All (Remote Command Only)

Clears the list of customer added LAN events that can cause the instrument to trigger. Events LAN0-LAN7 are not affected. As LAN events are removed, keys are removed from the LAN source menu. Key panels are removed as the number of possible LAN events decreases past a multiple of six, and the "More" keys are updated to reflect the new number of key panels in the LAN source menu.

It is not possible to remove the "LAN0" – "LAN7" events.

Remote Command	:TRIGger [:SEquence] :LXI :LAN :REMOve :ALL
Example	:TRIG:LXI:LAN:REM:ALL
Restriction and Notes	This command modifies the LXI Trigger LAN Event List Parameter.
Mode	SA, IQ(Basic)
Instrument S/W Revision	Prior to A.02.00

Event Filter (Remote Command Only)

Only LXI Trigger LAN Events coming from hosts matching the filter string are processed. There is no front panel access to this command

The syntax for specifying a filter is as follows:

Filter == ([host[:port]] | [ALL[:port]]) [,Filter]

Specifying an empty string means that LXI trigger packets are accepted as a Trigger from any port on any host on the network via either TCP or UDP.

Specifying only the port means that any host communicating over that port can send events.

Specifying ALL indicates that UDP multicast packets are accepted if they are directed to the Internet Assigned Numbers Authority (IANA) assigned multicast address on the IANA assigned default port, or the designated port if specified.

Examples:

"192.168.0.1:23"

"agilent.com, soco.agilent.com"

"agilent.com:80, 192.168.0.1"

Remote Command	:TRIGger [:SEquence] :LXI :LAN [:SET] :FILTer "LANEVENT", "filterString"
	:TRIGger [:SEquence] :LXI :LAN [:SET] :FILTer?
Example	:TRIG:LXI:LAN:FILT "LAN0","agilent.com" :TRIG:LXI:LAN:FILT?

Trigger

Restriction and Notes	The maximum length of the string is 45 characters. Nothing happens if the LAN event does not exist.
Mode	SA, IQ(Basic)
Preset	"" (empty string)
State Saved	Saved in instrument state.
Range	Uppercase, Lowercase, Numeric, Symbol
Instrument S/W Revision	Prior to A.02.00

Count (Remote Command Only)

Returns the number of items in the LXI Trigger LAN Event List.

Remote Command	:TRIGger[:SEquence]:LXI:LAN:COUNT?
Example	:TRIG:LXI:LAN:COUN?
Mode	SA, IQ(Basic)
Instrument S/W Revision	Prior to A.02.00

Identifier (Remote Command Only)

Sets the string that is expected to arrive over the LAN for a given Trigger LAN Event to occur. The Identifier is variable to allow for easier system debugging.

Remote Command	:TRIGger[:SEquence]:LXI:LAN[:SET]:IDENTifier "LANEVENT", "identifier" :TRIGger[:SEquence]:LXI:LAN[:SET]:IDENTifier? "LANEVENT"
Example	:TRIG:LXI:LAN:IDEN "LAN0","debugstring"
Restriction and Notes	The maximum length of the string is 16 characters. Nothing happens if the LAN event does not exist. The default value is that the identifier is equivalent to the name of the LAN Event.
Mode	SA, IQ(Basic)
State Saved	Saved in instrument state.
Range	Uppercase, Lowercase, Numeric, Symbol
Instrument S/W Revision	Prior to A.02.00

Configure (Remote Command Only)

Allows the configuration of some of the above parameters from a single SCPI command.

Remote Command	:TRIGger[:SEquence]:LXI:LAN[:SET]:CONFigure "lanEvent", <enable>, <detection>, <delay>, <filter>, <identifier>
Example	:TRIG:LXI:LAN:CONF "LAN0",1,FALL,0.0,"ALL","debugIdentifier"
Mode	SA, IQ(Basic)
Instrument S/W Revision	Prior to A.02.00

Alarm

Pressing this key when it is not selected selects the alarm system as the LXI trigger. A new sweep/measurement starts when the configured IEEE 1588 time occurs if the LXI trigger is selected as the active trigger (see [“LXI Trigger” on page 666](#)). Pressing this key when it is already selected accesses the alarm source selection menu.

Example	TRIG:ACP:SOUR ALAR
SCPI Status Bits/OPC Dependencies	The Status Operation Register bit 5 "Waiting for Trigger" is set at the same time as the Sweeping or Measuring bit is set. It is cleared when the trigger actually occurs (that is, after the trigger event occurs and all the applicable trigger criteria have been met). A corresponding pop-up message ("Waiting for trigger") is generated if no trigger signal appears after approximately 2 sec. This message goes away when a trigger signal appears.
Key Path	Trigger LXI Trigger
Mode	SA, IQ(Basic)
Preset	ON
State Saved	Saved in instrument state.
Instrument S/W Revision	Prior to A.02.00

Disable All

This key causes all Alarms in the trigger alarm list to go into the disabled state.

(Enabled = OFF)

Remote Command	:TRIGger[:SEquence]:LXI:ALARm:DISable:ALL
Example	:TRIG:LXI:ALAR:DIS:ALL
Key Path	Trigger, LXI Trigger, Alarm
Mode	SA, IQ(Basic)
Instrument S/W Revision	Prior to A.02.00

Trigger

Alarm List

After selecting Alarm as the trigger source, you are presented with a list of possible alarms. Pressing an alarm (e.g. "ALARM0") branches to the alarm setup menu.

Remote Command	:TRIGger [:SEquence] :LXI :ALARm:LIST?
Example	:TRIG:LXI:ALAR:LIST? Returns the complete list of Alarm events which is: "ALARM0"
Key Path	Trigger, LXI Trigger, Alarm
Mode	SA, IQ(Basic)
Preset	"ALARM0"
State Saved	Saved in instrument state.
Readback	Displays the value of the LXI Trigger Alarm Enabled parameter (Enabled Disabled).
Instrument S/W Revision	Prior to A.02.00

Date/Time

Absolute alarm time sets an alarm for one specific time using the date and time of day (e.g. 12/14/2007 at 11:45:15.3456). The Date and Time are represented in the instrument's local time. This is the only way to set an alarm from the front panel.

Epoch time is another type of absolute alarm time. A specific time is identified by the number of seconds it occurs after January 1, 1970 00:00:00 in International Atomic Time (TAI). Epoch Time is time zone invariant. Epoch time is only set via remote; see ["Epoch Time Value \(Remote Command Only\)"](#) on page 677.

The date and time the alarm is scheduled to go off is noted on the branch key.

NOTE	The Epoch Time Second and Epoch Time Fraction are the ultimate source of alarm information. The Absolute Time and Date may be changed from the front panel without being applied. When querying the Absolute Time and Date parameters from SCPI, if the Absolute Time and Date have not been applied (and therefore do not match the Epoch Time Second and Epoch Time Fraction), the string "(epoch time not set)" is added to the return value.
-------------	--

Key Path	Trigger, LXI Trigger, Alarm, <alarmEvent>
Mode	SA, IQ(Basic)
Readback	Annotated with the date and time the alarm is scheduled to go off.
Instrument S/W Revision	Prior to A.02.00
Remote Command	:TRIGger [:SEquence] :LXI:ALARm[:SET] :TIME[:VALue] :ABSolu te "alarmEvent", "date", "time"
Example	:TRIG:LXI:ALAR:TIME:ABS "ALARM0","2007/4/6", "15:45:02.123456"

Remote Command Notes	<p>"date" is a representation of the date the alarm should occur in the form of "YYYY/MM/DD" where:</p> <p>YYYY is the four digit representation of year. (for example, 2007)</p> <p>MM is the two digit representation of month. (for example. 01 to 12)</p> <p>DD is the two digit representation of day. (for example, 01 to 28, 29, 30, or 31 depending on the month and year)</p> <p>"time" is a representation of the time of day the alarm should occur in the form of "HH:MM:SS.SSSSSS" where:</p> <p>HH is the two digit representation of the hour in 24 hour format</p> <p>MM is the two digit representation of minute</p> <p>SS.SSSSSS is a real representing seconds (for example 02.123456)</p>
Key Path	Trigger, LXI Trigger, Alarm, <alarmEvent>,Time
Mode	SA, IQ(Basic)
Preset	Current date at initialization at 00:00:00.000000
State Saved	Saved in instrument state.
Instrument S/W Revision	Prior to A.02.00
Remote Command	<code>:TRIGger [:SEquence] :LXI:ALARm [:SET] :TIME [:VALue] :ABSolute? "alarmEvent "</code>
Example	<p><code>:TRIG:LXI:ALAR:TIME:ABS? "ALARM0"</code></p> <p>This query returns data using the following format "YYYY/MM/DD HH:MM:SS.SSSSSS" If the Absolute time has been changed from the front panel, but has not been applied, the return value is of the form "YYYY/MM/DD HH:MM:SS.SSSSSS (epoch time not set)".</p>
Remote Command Notes	<p><date> is a representation of the date the alarm should occur in the form of YYYY/MM/DD where:</p> <p>YYYY is the four digit representation of year. (for example, 2007)</p> <p>MM is the two digit representation of month. (for example. 01 to 12)</p> <p>DD is the two digit representation of day. (for example, 01 to 28, 29, 30, or 31 depending on the month and year)</p> <p><time> is a representation of the time of day the alarm should occur in the form of HH:MM:SS.SSSSSS where:</p> <p>HH is the two digit representation of the hour in 24 hour format</p> <p>MM is the two digit representation of minute</p> <p>SS.SSSSSS is a real representing seconds (for example 02.123456)</p>
Key Path	Trigger, LXI Trigger, Alarm, <alarmEvent>,Time
Mode	SA, IQ(Basic)

Trigger

Preset	Current date at initialization at 00:00:00.000000
State Saved	Saved in instrument state.
Instrument S/W Revision	Prior to A.02.00

Date

The date the alarm should occur. All absolute alarm time parameters are set using the same SCPI command; however they each have their own front panel control.

When setting alarm values from the front panel, the new alarm time is not registered with the alarm system until the "Set" key is pressed.

Key Path	Trigger, LXI Trigger, Alarm, <alarmEvent>,Time
Mode	SA, IQ(Basic)
Preset	Current date
State Saved	Saved in instrument state.
Range	current date – 214748/12/31. Values representing a time in the past result in an error.
Instrument S/W Revision	Prior to A.02.00

Time

The time of the day, in the instrument's local time (this takes into account time zones and daylight savings time), the alarm should occur. This parameter is based on a 24 hour clock.

All absolute alarm time parameters are set using the same SCPI command; however they each have their own front panel control.

When setting alarm values from the front panel, the new alarm time is not registered with the alarm system until the "Set" key is pressed.

Restriction and Notes	Uses a 24 hour clock. Values representing a time in the past result in an error. Only valid time values are accepted. The <second> field accepts a decimal number, and is valid to the microsecond position. The <year>, <month>, <hour>, and <minute> fields all accept integers.
Key Path	Trigger, LXI Trigger, Alarm, <alarmEvent>,Time
Mode	SA, IQ(Basic)
Preset	00:00:00.000000
State Saved	Saved in instrument state.
Range	00:00:00.000000 – 23:59:59.999999

Instrument S/W Revision Prior to A.02.00

Apply (Front Panel Only)

Causes the Absolute Alarm Time values to be converted into an Epoch time (see “[Epoch Time Value \(Remote Command Only\)](#)” on page 677), compared to the current time, and sent to the Alarm Trigger subsystem. This key can only be pressed when the epoch time and the absolute time are out of synch.

Restriction and Notes Alarm times are settable to microsecond resolution.

Key Path **Trigger, LXI Trigger, Alarm, <alarmEvent>,Time**

Mode SA, IQ(Basic)

Instrument S/W Revision Prior to A.02.00

Epoch Time Value (Remote Command Only)

Sets the LXI Alarm Time. This represents the number of seconds after January 1, 1970 00:00:00, in TAI time, that the alarm should go off.

Remote Command :TRIGger [:SEquence] :LXI :ALARm [:SET] :TIME [:VALue]
"alarmEvent", <seconds>, <fractionalSeconds>

Example :TRIG:LXI:ALAR:TIME "ALARM0",123456.0 S, 0.123456

Restriction and Notes Values representing a time in the past result in an error.

Mode SA, IQ(Basic)

Preset Seconds: The number of whole seconds between Jan 1, 1970 at 00:00:00 (in TAI time) and the current date at initialization at 00:00:00 (in TAI time)

FractionalSeconds: 0

State Saved Saved in instrument state.

Range Seconds: Epoch time of current date at 00:00:00 (in TAI time) –
253402300800 + number of seconds local time zone offset from UTC

FractionalSeconds: 0.0 – 0.999999

Instrument S/W Revision Prior to A.02.00

Remote Command :TRIGger [:SEquence] :LXI :ALARm [:SET] :TIME [:VALue] ?

Example :TRIG:LXI:ALAR:TIME?

Restriction and Notes Values representing a time in the past result in an error.

Mode SA, IQ(Basic)

Preset Seconds: The number of whole seconds between Jan 1, 1970 at 00:00:00 (in TAI time) and the current date at initialization at 00:00:00 (in TAI time)

FractionalSeconds: 0

State Saved Saved in instrument state.

Trigger

Range	Seconds: Epoch time of current date at 00:00:00 (in TAI time) – 253402300800 + number of seconds local time zone offset from UTC FractionalSeconds: 0.0 – 0.999999
Instrument S/W Revision	Prior to A.02.00

Epoch Time Seconds (Remote Command Only)

Sets the seconds portion of the LXI Alarm time. This represents the number of seconds after January 1, 1970 00:00:00 (in TAI time) that the alarm should go off.

Values must be in the form of whole seconds; decimal values result in an error.

Remote Command	:TRIGger[:SEquence]:LXI:ALARm[:SET]:TIME:SECOnds "alarmEvent", <seconds>
Example	:TRIG:LXI:ALAR:TIME:SEC "ALARM0",123456.0 S
Restriction and Notes	Values representing a time in the past result in an error. Values containing a decimal portion result in an error.
Mode	SA, IQ(Basic)
Preset	The number of whole seconds between Jan 1, 1970 at 00:00:00 (in TAI time) and the current date at initialization at 00:00:00 (in TAI time)
State Saved	Saved in instrument state.
Range	Epoch time of current date at 00:00:00 (in TAI time) – 253402300800 + number of seconds local time zone offset from UTC
Instrument S/W Revision	Prior to A.02.00

Remote Command	:TRIGger[:SEquence]:LXI:ALARm[:SET]:TIME:SECOnds? "alarmEvent"
Example	:TRIG:LXI:ALAR:TIME:SEC "ALARM0"?
Restriction and Notes	Values representing a time in the past result in an error. Values containing a decimal portion result in an error.
Mode	SA, IQ(Basic)
Preset	The number of seconds between Jan 1, 1970 at 00:00:00 (in TAI time) and the current date at initialization at 00:00:00 (in TAI time)
State Saved	Saved in instrument state.
Range	Epoch time of current date at 00:00:00 (in TAI time) – 253402300800 + number of seconds local time zone offset from UTC
Instrument S/W Revision	Prior to A.02.00

Epoch Time Fraction (Remote Command Only)

Sets the sub-second value of the Epoch time.

Remote Command	:TRIGger[:SEquence]:LXI:ALARm[:SET]:TIME[:VALue]:FRACtion "alarmEvent",<fractionalSeconds>
Example	:TRIG:LXI:ALAR:TIME:FRAC "ALARM0",0.123456 S
Restriction and Notes	Values representing a time in the past result in an error.
Mode	SA, IQ(Basic)
Preset	0
State Saved	Saved in instrument state.
Range	0.0 – 0.999999
Instrument S/W Revision	Prior to A.02.00

Remote Command	:TRIGger[:SEquence]:LXI:ALARm[:SET]:TIME[:VALue]:FRACtion? "alarmEvent"
Example	:TRIG:LXI:ALAR:TIME:FRAC "ALARM0"?
Restriction and Notes	Values representing a time in the past result in an error.
Mode	SA, IQ(Basic)
Preset	0
State Saved	Saved in instrument state.
Min	0.0
Max	0.999999
Instrument S/W Revision	Prior to A.02.00

Relative Time (Remote Command Only)

Sets the values of Epoch Time Seconds and Epoch Time Fraction by adding an offset to the time when the command is issued. For example, if the Relative Time command is issued with an argument of 60s, the alarm will occur 1 minute in the future.

Remote Command	:TRIGger[:SEquence]:LXI:ALARm[:SET]:TIME[:VALue]:RELative "alarmEvent",<seconds>
Example	:TRIG:LXI:ALAR:TIME:REL "ALARM0",60.0s
Mode	SA, IQ(Basic)
Range	0.0 – 1.7976931348623157 x 10308 (Max Double)
Instrument S/W Revision	Prior to A.02.00

Trigger

Remote Command	:TRIGger[:SEquence]:LXI:ALARm[:SET]:TIME[:VALue]:RELati ve? "alarmEvent"
Example	:TRIG:LXI:ALAR:TIME:REL "ALARM0"?
Mode	SA, IQ(Basic)
Range	0.0 – 1.7976931348623157 x 10308 (Max Double)
Instrument S/W Revision	Prior to A.02.00

Period

Sets the amount of time that should elapse between alarms in a repeating alarm trigger.

Remote Command	:TRIGger[:SEquence]:LXI:ALARm[:SET]:PERiod "alarmEvent", <seconds>
Example	:TRIG:LXI:ALAR:PER "ALARM0",1.2345 s
Restriction and Notes	A period of 0.0s effectively causes the trigger to occur only once, since all repetitions are fired simultaneously
Key Path	Trigger, LXI Trigger, Alarm, <alarmEvent>
Mode	SA, IQ(Basic)
Preset	0.0 s
State Saved	Saved in instrument state.
Range	0.0 – 1.7976931348623157 x 10308 (Max Double)
Instrument S/W Revision	Prior to A.02.00

Remote Command	:TRIGger[:SEquence]:LXI:ALARm[:SET]:PERiod? "alarmEvent"
Example	:TRIG:LXI:ALAR:PER "ALARM0"?
Restriction and Notes	A period of 0.0s effectively causes the trigger to occur only once, since all repetitions are fired simultaneously
Key Path	Trigger, LXI Trigger, Alarm, <alarmEvent>
Mode	SA, IQ(Basic)
Preset	0.0 s
State Saved	Saved in instrument state.
Range	0.0 – 1.7976931348623157 x 10308 (Max Double)
Instrument S/W Revision	Prior to A.02.00

Repetitions

Sets the number of times a repeating alarm should fire once the initial alarm time has occurred.

Remote Command	:TRIGger[:SEQuence]:LXI:ALARm[:SET]:REPeat "alarmEvent",<repetitions>
Example	:TRIG:LXI:ALAR:REP "ALARM0",10
Key Path	Trigger, LXI Trigger, Alarm, <alarmEvent>
Mode	SA, IQ(Basic)
Preset	1
State Saved	Saved in instrument state.
Range	1 – 2,147,483,647
Instrument S/W Revision	Prior to A.02.00

Remote Command	:TRIGger[:SEQuence]:LXI:ALARm[:SET]:REPeat? "alarmEvent"
Example	:TRIG:LXI:ALAR:REP "ALARM0",10
Key Path	Trigger, LXI Trigger, Alarm, <alarmEvent>
Mode	SA, IQ(Basic)
Preset	1
State Saved	Saved in instrument state.
Min	1
Max	2,147,483,647
Instrument S/W Revision	Prior to A.02.00

Enabled

If Enabled is set to ON and the trigger source is set to ALARm, this alarm causes the instrument to trigger.

If Enabled is set to OFF, this alarm is ignored

Remote Command	:TRIGger[:SEQuence]:LXI:ALARm[:SET]:ENABled "alarmEvent",ON OFF 1 0
Example	:TRIG:LXI:ALAR:ENAB "ALARM0",ON
Key Path	Trigger, LXI Trigger, Alarm, <alarmEvent>
Mode	SA, IQ(Basic)
Preset	OFF
State Saved	Saved in instrument state.

Trigger

Range	1 0
Instrument S/W Revision	Prior to A.02.00
Remote Command	:TRIGger[:SEquence]:LXI:ALARm[:SET]:ENABled? "alarmEvent"
Example	:TRIG:LXI:ALAR:ENAB "ALARM0"?
Key Path	Trigger, LXI Trigger, Alarm, <alarmEvent>
Mode	SA, IQ(Basic)
Preset	OFF
State Saved	Saved in instrument state.
Range	1 0
Instrument S/W Revision	Prior to A.02.00

Configure (Remote Command Only)

Allows the configuration of some of the above parameters from a single SCPI command.

Remote Command	:TRIGger[:SEquence]:LXI:ALARm[:SET]:CONFigure "alarmEvent", <enable>, <epochSeconds>, <epochFraction>, <period>, <repeat>
Example	:TRIG:LXI:ALAR:CONF "ALARM0",1,1000000.0,0.123456,1.2,3
Mode	SA, IQ(Basic)
Instrument S/W Revision	Prior to A.02.00

Count (Remote Command Only)

Returns the number of alarms in the LXI Trigger Alarm List.

Remote Command:	:TRIGger1 TRIGger[:SEquence]:LXI:ALARm:COUNT?
Example:	:TRIG:LXI:ALAR:COUN?
Instrument S/W Revision:	Prior to A.02.00

Baseband I/Q

Pressing this key when it is not selected selects Baseband I/Q as the trigger. Pressing the key when it is already selected accesses the Baseband I/Q trigger type selection menu. The key is annotated to display which of the Baseband I/Q trigger types is currently selected.

Key Path	Trigger
Mode	SA, IQ(Basic)

State Saved	No
Readback	The Baseband I/Q trigger source that becomes active when this key is selected is displayed. The possible values are "I/Q Mag", "I", "Q", "Input I", "Input Q", and "Aux I/Q Mag".
Instrument S/W Revision	Prior to A.02.00

I/Q Mag

Pressing this key, when it is not selected, selects the I/Q magnitude signal as the trigger. The I/Q Magnitude trigger condition is met when the I/Q magnitude crosses the I/Q magnitude trigger level. The magnitude is measured at the output of the main I/Q digital receiver.

Example	TRIG:<meas>:SOUR IQM
Key Path	Trigger, Baseband I/Q
Readback Text	I/Q Mag
Instrument S/W Revision	Prior to A.02.00

Trigger Level

Sets a level for the I/Q magnitude trigger. When the signal crosses this level, with the chosen slope, the trigger occurs. If the specific Measurement displays the signal from the chosen sampling point a green line will be displayed to indicate the trigger level.

Remote Command	:TRIGger [:SEquence] :IQMag:LEVel <ampl > :TRIGger [:SEquence] :IQMag:LEVel?
Remote Command Notes	The I/Q reference impedance is used for converting between power and voltage.
Example	TRIG:IQM:LEV -30 dBm
Key Path	Trigger, Baseband I/Q, I/Q Mag
Preset	-25 dBm
State Saved	Saved in instrument state.
Range	-200 dBm to 100 dBm
Readback Text	<level> dBm
Instrument S/W Revision	Prior to A.02.00

Trigger

Trig Slope

Controls the trigger polarity. It is set positive to trigger on a rising edge and negative to trigger on a falling edge.

Remote Command	:TRIGger[:SEquence]:IQMag:SLOPe POSitive NEGative :TRIGger[:SEquence]:IQMag:SLOPe?
Example	TRIG:IQM:SLOP POS
Key Path	Trigger, Baseband I/Q, I/Q Mag
Preset	POSitive
State Saved	Saved in instrument state.
Instrument S/W Revision	Prior to A.02.00

Trig Delay

Controls a time delay during which the analyzer will wait to begin a sweep after meeting the trigger criteria. You can use negative delay to pre-trigger the instrument in time domain or FFT.

Remote Command	:TRIGger[:SEquence]:IQMag:DELay <time> :TRIGger[:SEquence]:IQMag:DELay? :TRIGger[:SEquence]:IQMag:DELay:STATe OFF ON 0 1 :TRIGger[:SEquence]:IQMag:DELay:STATe?
Example	TRIG:IQM:DEL 10 ms TRIG:IQM:DEL:STAT ON
Key Path	Trigger, Baseband I/Q, I/Q Mag
Preset	1 us OFF
State Saved	Saved in instrument state.
Range	-2.5 s to +10 s
Instrument S/W Revision	Prior to A.02.00

I (Demodulated)

Pressing this key, when it is not selected, selects the main receiver's output I voltage as the trigger. The I (Demodulated) trigger condition is met when the I voltage crosses the I voltage trigger level.

Example	TRIG:<meas>:SOUR IDEM
Key Path	Trigger, Baseband I/Q
Readback Text	I

Instrument S/W Revision Prior to A.02.00

Trigger Level

Sets a level for the I (Demodulated) trigger. When the signal crosses this level, with the chosen slope, the trigger occurs. If the specific Measurement displays the signal from the chosen sampling point a green line will be displayed to indicate the trigger level.

Remote Command	:TRIGger[:SEquence]:IDEMod:LEVel <voltage> :TRIGger[:SEquence]:IDEMod:LEVel?
Example	TRIG:IDEM:LEV 0.5 V
Key Path	Trigger, Baseband I/Q, I (Demodulated)
Preset	0.25 V
State Saved	Saved in instrument state.
Range	-1 to 1 V
Readback Text	0.1 of displayed unit (V, mV, etc.)
Instrument S/W Revision	Prior to A.02.00

Trig Slope

Controls the trigger polarity. It is set positive to trigger on a rising edge and negative to trigger on a falling edge.

Remote Command	:TRIGger[:SEquence]:IDEMod:SLOPe POSitive NEGative :TRIGger[:SEquence]:IDEMod:SLOPe?
Example	TRIG:IDEM:SLOP POS
Key Path	Trigger, Baseband I/Q, I (Demodulated)
Preset	POSitive
State Saved	Saved in instrument state.
Instrument S/W Revision	Prior to A.02.00

Trig Delay

Controls a time delay during which the analyzer will wait to begin a sweep after meeting the trigger criteria. You can use negative delay to pre-trigger the instrument in time domain or FFT.

Remote Command	:TRIGger[:SEquence]:IDEMod:DELAy <time> :TRIGger[:SEquence]:IDEMod:DELAy? :TRIGger[:SEquence]:IDEMod:DELAy:STATe OFF ON 0 1 :TRIGger[:SEquence]:IDEMod:DELAy:STATe?
-----------------------	--

Trigger

Example	TRIG:IDEM:DEL 10 ms TRIG:IDEM:DEL:STAT ON
Key Path	Trigger, Baseband I/Q, I (Demodulated)
Preset	1 us OFF
State Saved	Saved in instrument state.
Range	-2.5 s to +10 s
Instrument S/W Revision	Prior to A.02.00

Q (Demodulated)

Pressing this key, when it is not selected, selects the main receiver's output Q voltage as the trigger. The Q (Demodulated) trigger condition is met when the Q voltage crosses the Q voltage trigger level.

Example	TRIG:<meas>:SOUR QDEM
Key Path	Trigger, Baseband I/Q
Readback Text	Q
Instrument S/W Revision	Prior to A.02.00

Trigger Level

Sets a level for the Q (Demodulated) trigger. When the signal crosses this level, with the chosen slope, the trigger occurs. If the specific Measurement displays the signal from the chosen sampling point a green line will be displayed to indicate the trigger level.

Remote Command	:TRIGger [:SEquence] :QDEMod:LEVel <voltage> :TRIGger [:SEquence] :QDEMod:LEVel?
Example	TRIG:QDEM:LEV 0.5 V
Key Path	Trigger, Baseband I/Q, Q (Demodulated)
Preset	0.25 V
State Saved	Saved in instrument state.
Range	-1 to 1 V
Readback Text	0.1 of displayed unit (V, mV, etc.)
Instrument S/W Revision	Prior to A.02.00

Trig Slope

Controls the trigger polarity. It is set positive to trigger on a rising edge and negative to trigger on a falling edge.

Remote Command	:TRIGger[:SEQuence]:QDEMod:SLOPe POSitive NEGative :TRIGger[:SEQuence]:QDEMod:SLOPe?
Example	TRIG:QDEM:SLOP POS
Key Path	Trigger, Baseband I/Q, Q (Demodulated)
Preset	POSitive
State Saved	Saved in instrument state.
Instrument S/W Revision	Prior to A.02.00

Trig Delay

Controls a time delay during which the analyzer will wait to begin a sweep after meeting the trigger criteria. You can use negative delay to pre-trigger the instrument in time domain or FFT.

Remote Command	:TRIGger[:SEQuence]:QDEMod:DELay <time> :TRIGger[:SEQuence]:QDEMod:DELay? :TRIGger[:SEQuence]:QDEMod:DELay:STATe OFF ON 0 1 :TRIGger[:SEQuence]:QDEMod:DELay:STATe?
Example	TRIG:QDEM:DEL 10 ms TRIG:QDEM:DEL:STAT ON
Key Path	Trigger, Baseband I/Q, Q (Demodulated)
Preset	1 us OFF
State Saved	Saved in instrument state.
Range	-2.5 s to +10 s
Instrument S/W Revision	Prior to A.02.00

Input I

Pressing this key, when it is not selected, selects the I channel's ADC voltage as the trigger. The Input I trigger condition is met when the voltage crosses the trigger level.

Example	TRIG:<meas>:SOUR IINP
Key Path	Trigger, Baseband I/Q
Readback Text	Input I

Trigger

Instrument S/W Revision Prior to A.02.00

Trigger Level

Sets a level for the Input I trigger. When the signal crosses this level, with the chosen slope, the trigger occurs.

Remote Command	:TRIGger[:SEquence]:IINPut:LEVel <voltage> :TRIGger[:SEquence]:IINPut:LEVel?
Example	TRIG:IINP:LEV 0.5 V
Key Path	Trigger, Baseband I/Q, Input I
Preset	0.25 V
State Saved	Saved in instrument state.
Range	-1 to 1 V
Readback Text	0.1 of displayed unit (V, mV, etc.)
Instrument S/W Revision	Prior to A.02.00

Trig Slope

Controls the trigger polarity. It is set positive to trigger on a rising edge and negative to trigger on a falling edge.

Remote Command	:TRIGger[:SEquence]:IINPut:SLOPe POSitive NEGative :TRIGger[:SEquence]:IINPut:SLOPe?
Example	TRIG:IINP:SLOP POS
Key Path	Trigger, Baseband I/Q, Input I
Preset	POSitive
State Saved	Saved in instrument state.
Instrument S/W Revision	Prior to A.02.00

Trig Delay

Controls a time delay during which the analyzer will wait to begin a sweep after meeting the trigger criteria. You can use negative delay to pre-trigger the instrument in time domain or FFT.

Remote Command	:TRIGger[:SEquence]:IINPut:DELAy <time> :TRIGger[:SEquence]:IINPut:DELAy? :TRIGger[:SEquence]:IINPut:DELAy:STATe OFF ON 0 1 :TRIGger[:SEquence]:IINPut:DELAy:STATe?
-----------------------	--

Example	TRIG:IINP:DEL 10 ms TRIG:IINP:DEL:STAT ON
Key Path	Trigger, Baseband I/Q, Input I
Preset	1 us OFF
State Saved	Saved in instrument state.
Range	-2.5 s to +10 s
Instrument S/W Revision	Prior to A.02.00

Input Q

Pressing this key, when it is not selected, selects the Q channel's ADC voltage as the trigger. The Input Q trigger condition is met when the voltage crosses the trigger level.

Example	TRIG:<meas>:SOUR QINP
Key Path	Trigger, Baseband I/Q
Readback Text	Input Q
Instrument S/W Revision	Prior to A.02.00

Trigger Level

Sets a level for the Input Q trigger. When the signal crosses this level, with the chosen slope, the trigger occurs.

Remote Command	:TRIGger[:SEQuence]:QINPut:LEVel <voltage> :TRIGger[:SEQuence]:QINPut:LEVel?
Example	TRIG:QINP:LEV 0.5 V
Key Path	Trigger, Baseband I/Q, Input Q
Preset	0.25 V
State Saved	Saved in instrument state.
Range	-1 to 1 V
Readback Text	0.1 of displayed unit (V, mV, etc.)
Instrument S/W Revision	Prior to A.02.00

Trigger

Trig Slope

Controls the trigger polarity. It is set positive to trigger on a rising edge and negative to trigger on a falling edge.

Remote Command	<code>:TRIGger[:SEquence]:QINPut:SLOPe POSitive NEGative</code> <code>:TRIGger[:SEquence]:QINPut:SLOPe?</code>
Example	<code>TRIG:QINP:SLOP POS</code>
Key Path	Trigger, Baseband I/Q, Input Q
Preset	POSitive
State Saved	Saved in instrument state.
Instrument S/W Revision	Prior to A.02.00

Trig Delay

Controls a time delay during which the analyzer will wait to begin a sweep after meeting the trigger criteria. You can use negative delay to pre-trigger the instrument in time domain or FFT.

Remote Command	<code>:TRIGger[:SEquence]:QINPut:DELay <time></code> <code>:TRIGger[:SEquence]:QINPut:DELay?</code> <code>:TRIGger[:SEquence]:QINPut:DELay:STATE OFF ON 0 1</code> <code>:TRIGger[:SEquence]:QINPut:DELay:STATE?</code>
Example	<code>TRIG:QINP:DEL 10 ms</code> <code>TRIG:QINP:DEL:STAT ON</code>
Key Path	Trigger, Baseband I/Q, Input Q
Preset	1 us OFF
State Saved	Saved in instrument state.
Range	-2.5 s to +10 s
Instrument S/W Revision	Prior to A.02.00

Auxiliary Channel I/Q Mag

Pressing this key, when it is not selected, selects the Auxiliary Channel I/Q magnitude signal as the trigger. The Auxiliary Channel I/Q Magnitude trigger condition is met when the auxiliary receiver's I/Q magnitude output crosses the Auxiliary I/Q magnitude trigger level.

Example	<code>TRIG:<meas>:SOUR AIQM</code>
Key Path	Trigger, Baseband I/Q
Readback Text	Aux I/Q Mag

Instrument S/W Revision Prior to A.02.00

Trigger Level

Sets a level for the I/Q magnitude trigger. When the signal crosses this level, with the chosen slope, the trigger occurs.

Remote Command	:TRIGger[:SEquence]:AIQMag:LEVEl <ampl > :TRIGger[:SEquence]:AIQMag:LEVEl?
Remote Command Notes	The I/Q reference impedance is used for converting between power and voltage.
Example	TRIG:AIQM:LEV -30 dBm
Key Path	Trigger, Baseband I/Q, Aux Channel I/Q Mag
Preset	-25 dBm
State Saved	Saved in instrument state.
Range	-200 dBm to 100 dBm
Readback Text	<level> dBm
Instrument S/W Revision	Prior to A.02.00

Trig Slope

Controls the trigger polarity. It is set positive to trigger on a rising edge and negative to trigger on a falling edge.

Remote Command	:TRIGger[:SEquence]:AIQMag:SLOPe POSitive NEGative :TRIGger[:SEquence]:AIQMag:SLOPe?
Example	TRIG:AIQM:SLOP POS
Key Path	Trigger, Baseband I/Q, Aux Channel I/Q Mag
Preset	POSitive
State Saved	Saved in instrument state.
Instrument S/W Revision	Prior to A.02.00

Trigger

Trig Delay

Controls a time delay during which the analyzer will wait to begin a sweep after meeting the trigger criteria. You can use negative delay to pre-trigger the instrument in time domain or FFT.

Remote Command	<code>:TRIGger [:SEquence] :AIQMag:DElay <time></code> <code>:TRIGger [:SEquence] :AIQMag:DElay?</code> <code>:TRIGger [:SEquence] :AIQMag:DElay:STATe OFF ON 0 1</code> <code>:TRIGger [:SEquence] :AIQMag:DElay:STATe?</code>
Example	TRIG:AIQM:DEL 10 ms TRIG:AIQM:DEL:STAT ON
Key Path	Trigger, Baseband I/Q, Aux Channel I/Q Mag
Preset	1 us OFF
State Saved	Saved in instrument state.
Range	-2.5 s to +10 s
Instrument S/W Revision	Prior to A.02.00

Trigger Center Frequency

This key sets the center frequency to be used by the auxiliary receiver.

Remote Command	<code>:TRIGger [:SEquence] :AIQMag:CENTer <freq></code> <code>:TRIGger [:SEquence] :AIQMag:CENTer?</code>
Restriction and Notes	Trigger CF + 1/2 Trigger BW < Max Trigger CF - 1/2 Trigger BW > Min
Example	:TRIG:AIQM:CENT 10 MHz
Key Path	Trigger, Baseband I/Q, Aux Channel I/Q Mag
Preset	0 Hz
State Saved	Saved in instrument state.
Range	-40 MHz to 40 MHz
Instrument S/W Revision	Prior to A.02.00

Trigger Bandwidth

This key sets the information bandwidth used by the auxiliary receiver for the Auxiliary Channel I/Q Magnitude trigger.

Remote Command	:TRIGger [:SEQuence] :AIQMag:BA NDwidth <freq> :TRIGger [:SEQuence] :AIQMag:BA NDwidth?
Restriction and Notes	The combined sample rate for the main and auxiliary receivers cannot exceed 100 MSa/sec. The bandwidth available to the Trigger BW is limited to what is available after the main receiver's bandwidth (Info BW, sometimes pre-FFT BW) is set. Because of this limitation, the Max is not always achievable. The combination of Trigger Center Freq and Trigger BW is also limited: Trigger CF + 1/2 Trigger BW < Max Trigger CF – 1/2 Trigger BW > Min
Example	:TRIG:AIQM:BA ND 8 MHz
Key Path	Trigger, Baseband I/Q, Aux Channel I/Q Mag
Preset	Bandwidth option dependent: No Opt: 10 MHz Opt B25: 25 MHz Opt S40: 40 MHz
State Saved	Saved in instrument state.
Range	10 Hz to Maximum
Instrument S/W Revision	Prior to A.02.00

Auto/Holdoff

Opens up a menu that lets you adjust Auto Trigger and Trigger Holdoff parameters

Key Path	Trigger
Readback line	Displays a summary of the Auto Trig and Holdoff settings, in square brackets First line: Auto Off or Auto On Second Line: "Hldf" followed by: <ul style="list-style-type: none"> • If Holdoff is Off, readback Off • If Holdoff On and Type = Normal, readback value • If Holdoff On and Type = Above, readback value followed by AL • If Holdoff On and Type = Below, readback value followed by BL • If Holdoff Type selection is not supported by the current measurement, Holdoff Type is always Normal

Trigger

Instrument S/W Revision A.02.00

Auto Trig

Sets the time that the analyzer will wait for the trigger conditions to be met. If they are not met after that much time, then the analyzer is triggered anyway.

Remote Command: :TRIGger[:SEQuence]:ATRigger <time>
 :TRIGger[:SEQuence]:ATRigger?
 :TRIGger[:SEQuence]:ATRigger:STATe OFF|ON|0|1
 :TRIGger[:SEQuence]:ATRigger:STATe?

Example: TRIG:ATR:STAT ON
 TRIG:ATR 100 ms

Preset: Off, 100 ms
State Saved: Saved in instrument state.
Min: 1 ms
Max: 100 s
Key Path: **Trigger, Auto/Holdoff**
Default Unit: s
Instrument S/W Revision: Prior to A.02.00

Trig Holdoff

Sets the holdoff time between triggers. When the trigger condition is satisfied, the trigger occurs, the delay begins, and the holdoff time begins. New trigger conditions will be ignored until the holdoff time expires. For a free-running trigger, the holdoff value is the minimum time between triggers.

Remote Command: :TRIGger[:SEQuence]:HOLDoff <time>
 :TRIGger[:SEQuence]:HOLDoff?
 :TRIGger[:SEQuence]:HOLDoff:STATe OFF|ON|0|1
 :TRIGger[:SEQuence]:HOLDoff:STATe?

Example: TRIG:HOLD:STAT ON
 TRIG:HOLD 100 ms

Preset: Off, 100 ms
State Saved: Saved in instrument state.
Min: 0 s
Max: 0.5 s
Key Path: **Trigger, Auto/Holdoff**

Default Unit: s
 Instrument S/W Revision: Prior to A.02.00

Holdoff Type

Lets you set the Trigger Holdoff Type.

NOTE Holdoff Type is not supported by all measurements. If the current measurement does not support it, this key will be blank and the Holdoff Type will be Normal. If the Holdoff Type SCPI is sent while in such a measurement, the SCPI will be accepted and the setting remembered, but it will have no effect until a measurement is in force that supports Holdoff Type.

Trigger Holdoff Type functionality:

NORMAL

This is the “oscilloscope” type of trigger holdoff, and is the setting when the Holdoff Type key does not appear. In this type of holdoff, no new trigger will be accepted until the holdoff interval has expired after the previous trigger.

ABOVE

If the trigger slope is positive, a trigger event is generated only if the signal characteristic of interest crosses the trigger threshold (with positive slope) and then remains above the threshold for at least the holdoff time. For negative slope, the trigger event is generated if the signal characteristic crosses the threshold (with negative slope) after having been above the threshold for at least the holdoff time. In either case, the trigger event is associated with the time the level was crossed.

BELow

If the trigger slope is positive, a trigger event is generated only if the signal characteristic of interest crosses the trigger threshold (with positive slope) after having been below the threshold for at least the holdoff time. For negative slope, the trigger event is generated if the signal characteristic crosses the threshold (with negative slope) and then remains below the threshold for at least the holdoff time. In either case, the trigger event is associated with the time the level was crossed.

Remote Command: :TRIGger[:SEquence]:HOLDoff:TYPE NORMal|ABOVE|BELow
 :TRIGger[:SEquence]:HOLDoff:TYPE?

Example: TRIG:HOLD:TYPE NORM

Mode: GSM/EDGE

Preset: All modes but GSM/EDGE: Normal
 GSM/EDGE: Below

State Saved: Saved in instrument state.

Key Path: **Trigger, Auto/Holdoff**

Instrument S/W Revision: A.02.00

Trigger

Trigger Offset (Remote Command Only)

ESA Backwards Compatibility command

Remote Command: :TRIGger[:SEQuence]:OFFSet <time>
 :TRIGger[:SEQuence]:OFFSet?
 :TRIGger[:SEQuence]:OFFSet:STATe OFF|ON|0|1
 :TRIGger[:SEQuence]:OFFSet:STATe?

Example: TRIG:OFFS ON
 TRIG:OFFS -100 ms

Remote Command Notes: These are ESA commands for trigger offset that allowed you to use a positive or negative delay when in zero span and in a Res BW ≥ 1 kHz. For ESA compatibility, X-series analyzers keep track of this offset and add it to the Trigger Delay for line, video or external whenever the value is sent to the hardware, if in Zero Span and RBW ≥ 1 kHz.

Preset: Off, 0 s
State Saved: Saved in instrument state.
Min: -11 s
Max: +11 s
Instrument S/W Revision: Prior to A.02.00

View/Display

The View/Display key opens up the View menu for the current measurement. This menu includes the **Display** key for controlling items on the display. The Display functions are common across multiple Modes and Measurements and are described in this section. See each measurement description for information on data views that are unique to that Measurement.

Views are different ways of looking at data, usually different ways of looking at the same data, especially when the data represents a time record that is being digitally processed with an FFT and/or other digital signal processing algorithms. In some modes, like the Spectrum Analyzer mode, we are mostly concerned with swept spectrum analysis, and those views may represent different ways of looking at the same signal.

Key Path	Front-panel key
Instrument S/W Revision	Prior to A.02.00

Display

The **Display** menu is common to most measurements, and is used for configuring items on the display. Some **Display** menu settings apply to all the measurements in a mode, and some only to the current measurement. Those under the **System Display Settings** key apply to all measurements in all modes.

Key Path	View/Display
Instrument S/W Revision	Prior to A.02.00

Annotation

Turns on/off various parts of the display annotation. The annotation is divided up into four categories:

1. **Meas Bar:** This is the measurement bar at the top of the screen. It does not include the settings panel or the Active Function. Turning off the Meas Bar turns off the settings panel and the Active Function. When the Meas Bar is off, the graticule area expands to fill the area formerly occupied by the Meas Bar.
2. **Screen Annotation:** this is the annotation and annunciation around the graticule, including any annotation on lines (such as the display line, the threshold line, etc.) This does NOT include the marker number or the N dB result. When off, the graticule expands to fill the entire graticule area.
3. **Trace annotation:** these are the labels on the traces, showing their detector (or their math mode).
4. **Active Function annotation:** this is the active function display in the meas bar, and all of the active function values displayed on keys.

View/Display

See the figure below. Each type of annotation can be turned on and off individually.

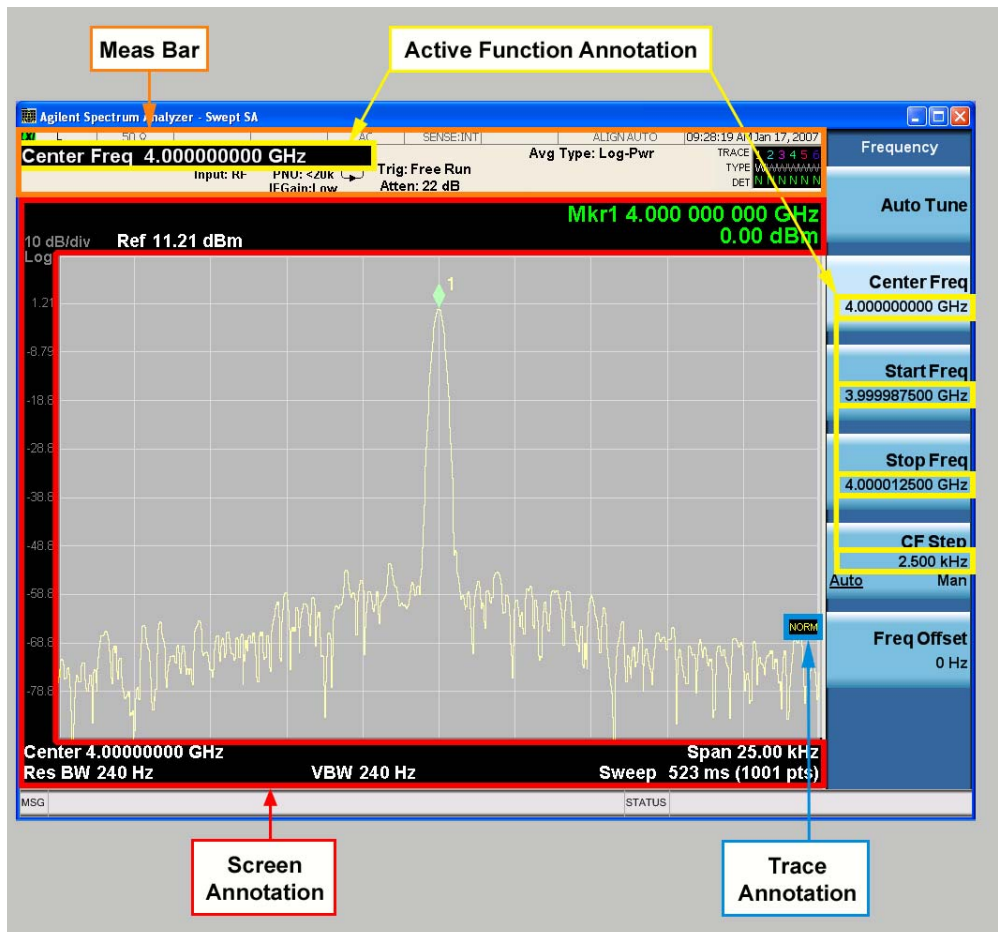

Key Path **View/Display, Display**

Instrument S/W Revision **Prior to A.02.00**

Meas Bar On/Off

This function turns the Measurement Bar on and off, including the settings panel. When off, the graticule area expands to fill the area formerly occupied by the Measurement Bar.

Remote Command: `:DISPlay:ANNotation:MBAR[:STATe] OFF|ON|0|1`

`:DISPlay:ANNotation:MBAR[:STATe]?`

Example: `DISP:ANN:MBAR OFF`

Dependencies/Couplings: Grayed out and forced to OFF when **System Display Settings, Annotation** is set to Off.

Preset: On

This should remain Off through a Preset when **System Display Settings, Annotation** is set to Off.

State Saved:	Saved in instrument state.
Key Path:	View/Display, Display, Annotation
Instrument S/W Revision:	Prior to A.02.00

Screen

This controls the display of the annunciation and annotation around the graticule, including any annotation on lines (such as the display line, the threshold line, etc.) and the y-axis annotation. This does NOT include marker annotation (or the N dB result). When off, the graticule expands to fill the entire graticule area, leaving only the 1.5% gap above the graticule as described in the Trace/Detector chapter.

Remote Command:	:DISPlay:ANNOtation:SCReen[:STATe] OFF ON 0 1 :DISPlay:ANNOtation:SCReen[:STATe] ?
Example:	DISP:ANN:SCR OFF
Dependencies/Couplings:	Grayed out and forced to OFF when System Display Settings, Annotation is set to Off.
Preset:	On This should remain Off through a Preset when System Display Settings, Annotation is set to Off
State Saved:	Saved in instrument state.
Key Path:	View/Display, Display, Annotation
Instrument S/W Revision:	Prior to A.02.00

Trace

Turns on and off the labels on the traces, showing their detector (or their math mode) as described in the Trace/Detector section.

If trace math is being performed with a trace, then the trace math annotation will replace the detector annotation.

Remote Command:	:DISPlay:ANNOtation:TRACe[:STATe] ON OFF 1 0 :DISPlay:ANNOtation:TRACe[:STATe] ?
Example:	DISP:ANN:TRAC OFF
Preset:	Off
State Saved:	Saved in instrument state.
Key Path:	View/Display, Display, Annotation
Instrument S/W Revision:	Prior to A.02.00

View/Display

Active Function Values On/Off

Turns on/off the active function display in the Meas Bar, and all of the active function values displayed on the keys.

Note that all of the keys that have active functions have these numeric values blanked when this function is on. This is a security feature.

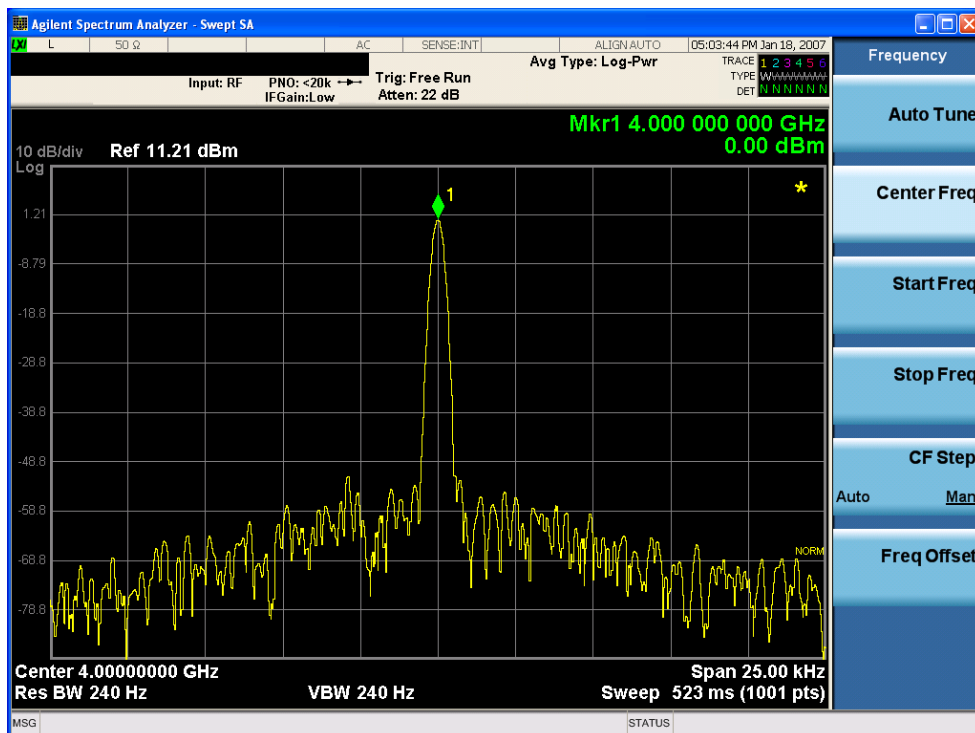

Remote Command: :DISPlay:ACTivefunc [:STATE] ON|OFF|1|0
 :DISPlay:ACTivefunc [:STATE] ?

Example: DISP:ACT OFF

Dependencies/Couplings: Grayed out and forced to OFF when **System Display Settings, Annotation** is set to Off.

Preset: On
 This should remain Off through a Preset when **System Display Settings, Annotation** is set to Off

State Saved: Saved in instrument state.

Key Path: **View/Display, Display, Annotation**

Instrument S/W Revision: Prior to A.02.00

Title

Displays menu keys that enable you to change or clear a title on your display.

Key Path	View/Display, Display
Instrument S/W Revision	Prior to A.02.00

Change Title

Writes a title into the "measurement name" field in the banner, for example, "Swept SA".

Press Change Title to enter a new title through the alpha editor. Press Enter or Return to complete the entry. Press ESC to cancel the entry and preserve your existing title.

The display title will replace the measurement name. It remains for this measurement until you press **Change Title** again, or you recall a state, or a Preset is performed. A title can also be cleared by pressing **Title, Clear Title**.

NOTE

Notice the inclusion of the <measurement> parameter in the command below. Because each measurement remembers the Display Title, the command must be qualified with the measurement name. For the Swept SA measurement this is not the case; for backwards compatibility, no <measurement> parameter is used when changing the Display Title for the Swept SA measurement.

Remote Command	:DISPlay:<measurement>:ANNotation:TITLe:DATA <string> :DISPlay:<measurement>:ANNotation:TITLe:DATA?
-----------------------	--

Example DISP:ANN:TITL:DATA "This Is My Title"

This example is for the Swept SA measurement in the Spectrum Analyzer mode. The SANalyzer <measurement> name is not used.

DISP:ACP:ANN:TITL:DATA "This Is My Title"

This example is for Measurements other than Swept SA.

Both set the title to: This Is My Title

Key Path	View/Display, Display, Title
Mode	All
Preset	No title (measurement name instead)
State Saved	Saved in instrument state.
Instrument S/W Revision	Prior to A.02.00

View/Display

Clear Title

Clears a title from the front-panel display. Once cleared, the title cannot be retrieved. After the title is cleared, the current Measurement Name replaces it in the title bar.

Example:	DISP:ANN:TITL:DATA "" clears any existing title characters.
Remote Command Notes:	Use the :DISPlay:ANNotation:TITLe:DATA <string> command with an empty string.
Preset:	Performed on Preset.
Key Path:	View/Display, Display, Title
Instrument S/W Revision:	Prior to A.02.00

Graticule

Pressing Graticule turns the display graticule On or Off. It also turns the graticule y-axis annotation on and off.

Remote Command:	:DISPlay:WINDow[1]:TRACe:GRATicule:GRID[:STATe] OFF ON 0 1 :DISPlay:WINDow[1]:TRACe:GRATicule:GRID[:STATe]?
Example:	DISP:WIND:TRAC:GRAT:GRID OFF
Preset:	On
State Saved:	saved in instrument state
Key Path:	View/Display, Display
Instrument S/W Revision:	Prior to A.02.00

Display Line

Activates an adjustable horizontal line that is used as a visual reference line. The line's vertical position corresponds to its amplitude value. The value of the display line (for example, "-20.3 dBm") appears above the line itself on the right side of the display in the appropriate font.

The display line can be adjusted using the step keys, knob, or numeric keypad. The unit of the Display Line is determined by the **Y axis unit** setting under **Amplitude**. If more than one window has a display line, the display line of the selected window is controlled.

If the display line is off the screen, it shows as a line at the top/bottom of the screen with an arrow pointing up or down. As with all such lines (Pk Thresh, Trigger Level, etc.) it is drawn on top of all traces.

The display line is unaffected by Auto Couple.

Remote Command:	:DISPlay:WINDow[1]:TRACe:Y:DLINe <amp;gt; :DISPlay:WINDow[1]:TRACe:Y:DLINe? :DISPlay:WINDow[1]:TRACe:Y:DLINe:STATe OFF ON 0 1 :DISPlay:WINDow[1]:TRACe:Y:DLINe:STATe?
Example:	DISP:WIND:TRAC:Y:DLIN:STAT ON DISP:WIND:TRAC:Y:DLIN:STAT -32 dBm
Preset:	Set the Display Line to Off and -25 dBm on Preset. When the Display Line goes from Off to On, if it is off screen, set it to either the top or bottom of screen, depending on which direction off screen it was. The Display Line's value does not change when it is turned off.
State Saved:	Saved in instrument state.
Min:	- (minus infinity) in current units
Max:	+ (plus infinity) in current units
Key Path:	View/Display, Display
Default Unit:	Depends on the current selected Y axis unit
Instrument S/W Revision:	Prior to A.02.00

System Display Settings

These settings are "Mode Global" – they affect all modes and measurements and are reset only by **Restore Misc Defaults** or **Restore System Defaults** under System.

Key Path	View/Display, Display, System Display Settings
Instrument S/W Revision	Prior to A.02.00

Annotation Local Settings/All Off

This is a Mode Global override of the meas local annotation settings. When it is **All Off**, it forces **Screen Annotation, Meas Bar, Trace, and Active Function Values** settings to be **OFF** for all measurements in all modes. This provides the security based "annotation off" function of previous analyzers; hence it uses the legacy SCPI command.

When it is **All Off, Screen, Meas Bar, Trace, and Active Function Values** keys under the **Display, Annotation** menu are grayed out and forced to **Off**. When **Local Settings** has been selected, you are able to set the local annotation settings on a measurement by measurement basis.

Remote Command:	:DISPlay:WINDow[1]:ANNotation[:ALL] OFF ON 0 1 :DISPlay:WINDow[1]:ANNotation[:ALL]?
------------------------	--

Example: :DISP:WIND:ANN OFF

View/Display

Preset:	On (Set by Restore Misc Defaults)
State Saved:	Not saved in instrument state.
Key Path:	View/Display, Display, System Display Settings, Annotation
Instrument S/W Revision:	Prior to A.02.00

Theme

This key allows you to change the Display theme. This is similar to the Themes selection under Page Setup and Save Screen Image. The four themes are detailed below.

Remote Command:	<code>:DISPlay:THEME TDColor TDMonochrome FCOLor FMONochrome</code> <code>:DISPlay:THEMe?</code>
Preset:	TDColor (Set by Restore Misc Defaults)
State Saved:	Not saved in instrument state.
Key Path:	View/Display, Display, System Display Settings
Remote Command Notes:	TDColor – 3D is the standard color theme with filling and shading TDMonochrome – is similar to 3D color, but only black is used FCOLor – flat color is intended for inkjet printers to conserve ink. It uses a white background instead of black. FMONochrome – is like flat color, but only black is used
Example:	DISP:THEM TDM sets the display theme to 3D Monochrome.
Instrument S/W Revision:	Prior to A.02.00

Backlight

Accesses the display backlight on/off keys. This setting may interact with settings under the Windows "Power" menu.

When the backlight is off, pressing ESC, TAB, SPACE, ENTER, UP, DOWN, LEFT, RIGHT, DEL, BKSP, CTRL, or ALT turns the backlight on without affecting the application. Pressing any other key will turn backlight on and could potentially perform the action as well.

Remote Command:	<code>:DISPlay:BACKlight ON OFF</code> <code>:DISPlay:BACKlight?</code>
Preset:	ON (Set by Restore Misc Defaults)
Key Path:	View/Display, Display, System Display Settings
Instrument S/W Revision:	Prior to A.02.00

On

Turns the display backlight on.

Example:	DISP:BACK ON
Key Path:	View/Display, Display, System Display Settings, Backlight
Readback:	On
Instrument S/W Revision:	Prior to A.02.00

Off

Turns the display backlight off.

Example:	DISP:BACK OFF
Key Path:	View/Display, Display, System Display Settings, Backlight
Readback:	Off
Instrument S/W Revision:	Prior to A.02.00

Backlight Intensity

An active function used to set the backlight intensity. It goes from 0 to 100 where 100 is full on and 0 is off. This value is independent of the values set under the Backlight on/off key.

Remote Command:	:DISPlay:BACKlight:INTensity <integer> :DISPlay:BACKlight:INTensity?
Example:	DISP:BACK:INT 50
Preset:	100 (Set by Restore Misc Defaults)
Min:	0
Max:	100
Key Path:	View/Display, Display, System Display Settings
Instrument S/W Revision:	Prior to A.02.00

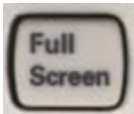
Full Screen

When **Full Screen** is pressed the measurement window expands horizontally over the entire instrument display. The screen graticule area expands to fill the available display area.

It turns off the display of the key labels, however the menus and active functions still work. (Though it would obviously be very hard to navigate without the key labels displayed.) Pressing **Full Screen** again

View/Display

while Full Screen is in effect cancels Full Screen.

Note that the banner and status lines are unaffected. You can get even more screen area for your data display by turning off the Meas Bar (in the Display menu) which also turns off the settings panel.

Full Screen is a Meas Global function. Therefore it is cancelled by the **Preset** key.

Remote Command: :DISPlay:FSCReen[:STATe] OFF|ON|0|1
 :DISPlay:FSCReen[:STATe]?

Preset: Off

State Saved: Not saved in state.

Key Path: **Display**

Instrument S/W Revision: Prior to A.02.00

Display Enable (Remote Command Only)

Turns the display on/off, including the display drive circuitry. The backlight stays lit so you can tell that the instrument is on. The display enable setting is mode global. The reasons for turning the display off are three:

- To increase speed as much as possible by freeing the instrument from having to update the display
- To reduce emissions from the display, drive circuitry
- For security purposes

If you have turned off the display:

- and you are in local operation, the display can be turned back on by pressing any key or by sending the SYSTem:DEFaults MISC command or the DISPlay:ENABle ON (neither *RST nor SYSTem:PRESet enable the display.)
- and you are in remote operation, the display can be turned back on by pressing the **Local** or **Esc** keys or by sending the SYSTem:DEFaults MISC command or the DISPlay:ENABle ON (neither *RST nor SYSTem:PRESet enable the display.)

and you are using either the SYSTem:KLOCK command or GPIB local lockout, then no front-panel key press will turn the display back on. You must turn it back on remotely.

Remote Command: :DISPlay:ENABle OFF|ON|0|1
 :DISPlay:ENABle?

Example: DISP:ENAB OFF

Dependencies/Couplings: DISP:ENAB OFF turns Backlight OFF and DISP:ENAB ON turns Backlight ON. However, settings of Backlight do not change the state of DISP:ENAB

Preset: On
Set by SYST:DEF MISC, but Not affected by *RST or SYSTem:PRESet.

State Saved: Not saved in instrument state.

Instrument S/W Revision: Prior to A.02.00

